

Legendary

AUTO INTERIORS LTD.

THE FINEST COLLECTION OF INTERIOR AND EXTERIOR PRODUCTS

2023
FIRST
QUARTER



OLDSMOBILE

**64-72 CUTLASS
& 442**



www.legendaryautointeriors.com



WE'RE NOT JUST CHRYSLER ANYMORE!

1964-72 CHEVELLE/EL CAMINO, GTO/LEMANS, CUTLASS/442 & SKYLARK/GS
1970-72 MONTE CARLO, 1970-72 NOVA & 1967-81 CAMARO & FIREBIRD



WWW.LEGENDARYAUTOINTERIORS.COM

A Special Message from the President...

For over 3 decades, Legendary Auto Interiors, Ltd has been committed to providing the automotive restoration industry and enthusiast with the world's highest quality soft trim products and services. Available from the most authentic "As Original" interiors to the most extreme "One of a Kind" Custom Resto-Mod interiors, Legendary has been relied upon and Legendary has delivered!

This past decade has been extremely exciting! We continue to set the bar and truly lead by example, establishing industry expectations and standards. Introducing innovative tools such as our exclusive "Custom Design Center", "LegendImagery™" and "Sample Request Center". Whether your preference is "As Original" or a creation of your own vision, we have created a destination where you can let your imagination lead the way! Our commitment to developing and maintaining innovative solutions is a dedicated process that will continue to provide you with great products, service and help grow our restoration industry.

We are looking forward to a very productive future. As owner and President and from all of our proud team here at Legendary Auto Interiors LTD, we would like to thank you for allowing us the opportunity and the privilege of being your automotive soft trim supplier.

Thank you once again for your business, interest and support!

Sincerely yours,

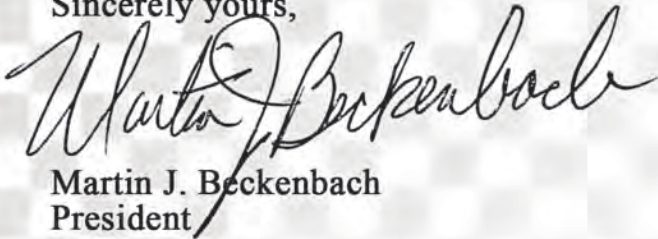

Martin J. Beckenbach
President

PRODUCT DISCLAIMER: Products listed in this catalog have been reproduced and/or remanufactured to resemble original products. All manufacturers names and descriptions are used for reference purposes only. It is therefore understood that the products listed in this catalog are in fact REPRODUCTIONS unless specified otherwise. All parts described and offered for sale in this publication as NOS (New Old Stock) are new parts/materials manufactured by or for Chrysler LLC and General Motors Corporation.

All literature produced by and directly related to Legendary Auto Interiors Ltd., is protected under copyright laws.
All literature cannot be reproduced for any reason unless prior permission is obtained.



FLEX TREAD®

YOU ASK FOR IT...WE DELIVERED!!

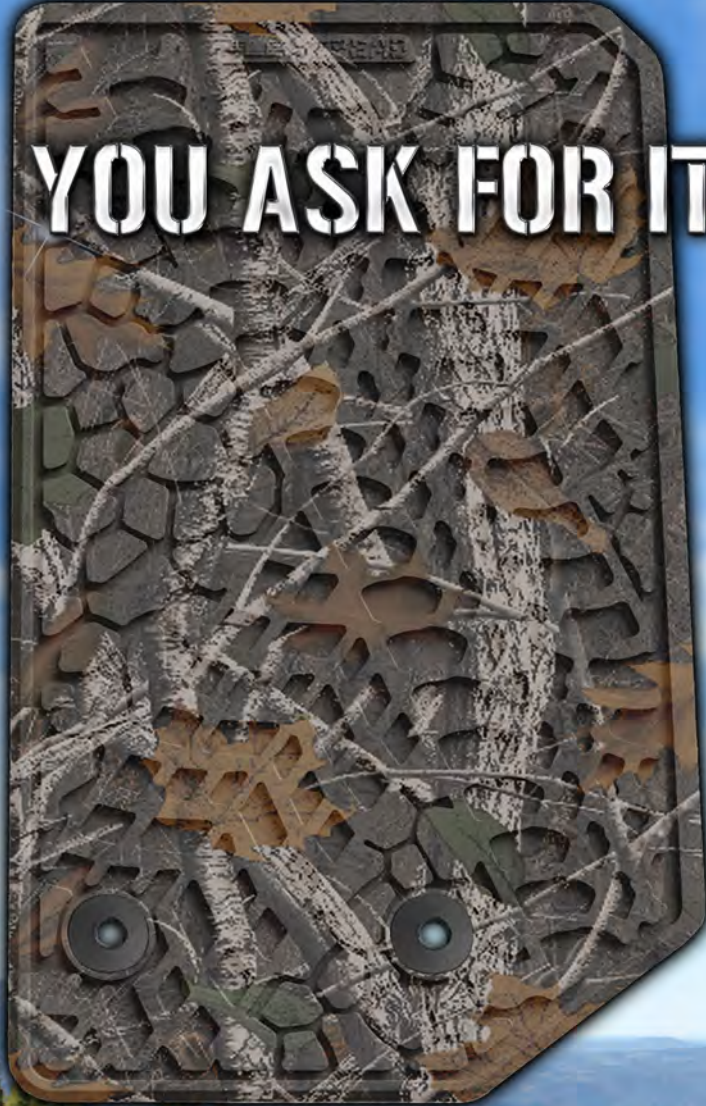

PINK COMING
2023!



YOU ASK FOR IT...WE DELIVERED!!

PATENTED
SCENERY
MATS

**MANY KOOL SCENES AVAILABLE
AND MORE COMING SOON!**

VERSAFIT™ TRIM-TO-FIT MATS



FISHING SCENE

BOOTMATS



DUCK SCENE

SCENERY AVAILABLE ON VERSAFIT™ & BOOTMATS



WHITETAIL SCENE



EQUINE SCENE



**SCORCHED EARTH &
TIRE TRACK SCENE**

Versafit™

Trim-To-Fit Mats

CHOOSE
YOUR
SCENE

VERSAFIT™ universal trim-to-fit floor mats fit most domestic and foreign vehicles. Mats can be cut to fit your vehicle's unique floorpan. Includes manual screw in style safety retention positioning posts for installation.



Bootmats

CHOOSE
YOUR
SCENE

"Fun"ctional Boot Mats from FLEXTREAD bring a KOOL look inside while leaving the mess at the door. Featuring scenery and measuring finished size 16" tall by 28" wide.



FLOORMAT & BOOTMAT COLORS



001 - Black



007 - Dark Blue



011 - Medium Blue



018 - Bright Red



020 - Red



023 - Tan



031 - Maroon



050 - Turquoise



057 - Dark Olive Green



074 - Pink



079 - Grey



098 - Brown



129 - Dark Saddle



132 - Gold

CAMOUFLAGE



200 - Rugged Woods



202 - Cyberflage



201 - Rugged Woods "Pink"



203 - Cyberflage "Pink"

FLEXTREAD LLC
1-833-700-3539 EXT. 222
WWW.FLEXTREADMATS.COM





Providing the automotive industry
with the world's highest quality
soft trim products and services
RIGHT HERE AT HOME

STILL ASSEMBLED AND
MADE IN THE ★★★★★
USA 

THERE REALLY IS A DIFFERENCE!!

Legendary
AUTO INTERIORS LTD.

www.legendaryautointeriors.com



INTRODUCING THE BEST WARRANTY COVERAGE IN THE INDUSTRY!!

Limited Lifetime Warranty

Limited Warranty - Legendary Auto Interiors Ltd. (called "we") warrants that the products it manufactures will be free of defects in materials and workmanship from the date it is first purchased by the retail purchaser. A retail purchaser is any person or any entity who or which purchases the product but does not do so for resale.

Obligation - If a product is not as warranted, we will either repair or, at our option, replace the defective product. If repair or replacement is not possible within a reasonable time, we will refund the purchase price.

Exclusions from Warranty - This Warranty does not apply to:

1. Conditions resulting from the product being altered, abused, misused, damaged by accident or negligence; being repaired without our authorization; or not being maintained properly in accordance with written instructions provided with the product.
2. Conditions resulting from ordinary wear and tear or including, without limitation, exposure to ultraviolet light.
3. Conditions resulting from the use of Specialty Run Materials (SRM) supplied by the purchaser.
4. Conditions resulting from improper installation by the purchaser or anyone else outside of our control.

Disclaimer - EXCEPT FOR THE LIMITED WARRANTY DESCRIBED ABOVE, WE OFFER NO WARRANTIES, EXPRESSED OR IMPLIED, AND OTHER THAN THE LIMITED WARRANTY EXPRESSLY CONTAINED HEREIN, WE HEREBY DISCLAIM ANY AND ALL WARRANTIES, INCLUDING WITHOUT LIMITATION ANY IMPLIED WARRANTIES OF MERCHANTABILITY, SUITABILITY OR FITNESS FOR A PARTICULAR PURPOSE. Some states do not allow limitations on how long an implied warranty lasts, so the above limitation may not apply to you.

Exclusion of Incidental and Consequential Damages - WE ARE NOT RESPONSIBLE FOR ANY INCIDENTAL OR CONSEQUENTIAL DAMAGES RESULTING FROM BREACH OF THE LIMITED WARRANTY DESCRIBED ABOVE. Some states do not allow the exclusion or limitation of incidental or consequential damages, so the above limitation or exclusion may not apply to you.

Other Legal Rights - This Warranty gives you specific legal rights, and you may also have other rights which vary from state to state.

What To Do If You Have A Warranty Claim - If you have a warranty claim, you must call our sales office for further assistance. Once given a return authorization number please indicate the number on the box and return the product to our facility; Legendary Auto Interiors 121 West Shore Blvd, Newark, NY 14513. We will perform our warranty obligation within a reasonable amount of time after the returned product arrives at our facility.



PRODUCT DISCLAIMER: Products listed in this catalog have been reproduced and/or remanufactured to resemble original products. All manufacturers names and descriptions are used for reference purposes only. It is therefore understood that the products listed in this catalog are in fact REPRODUCTIONS unless specified otherwise. All parts described and offered for sale in this publication as NOS (New Old Stock) are new parts/materials manufactured by or for CHRYSLER GROUP LLC and General Motors Corporation.

LEGENDARY AUTO INTERIORS LTD., COPYRIGHT 2022

All literature produced by and directly related to Legendary Auto Interiors Ltd., is protected under copyright laws. All literature cannot be reproduced for any reason unless prior permission is obtained.

Vinyl Grain Chart



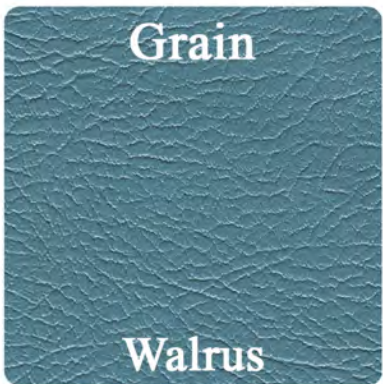
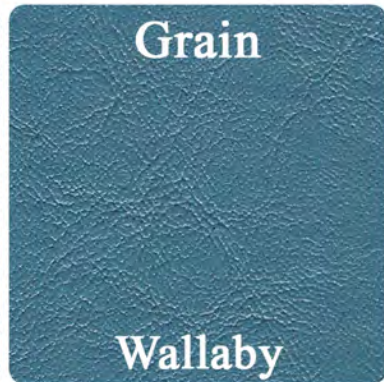
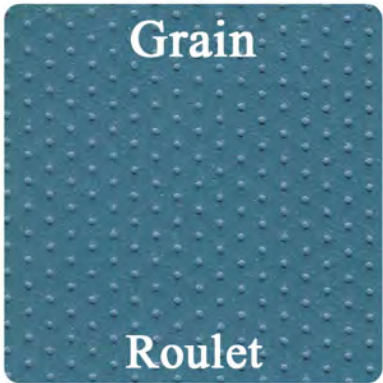
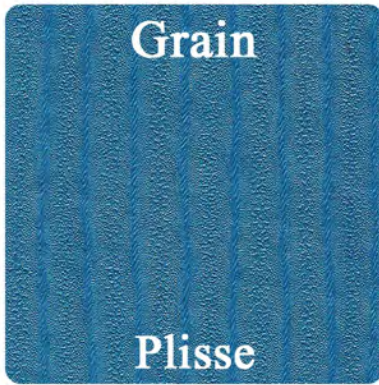

Vinyl Grain Chart





Vinyl Yardage

The following grains are available off the roll and come in 1/2 yard increments **ONLY**

Ascot
 VVYDASCOT(C) (1 Yard).....\$64.00/yd. 
 VV1/2YDASCOT(C) (1/2 Yard).....\$32.00/ea.
 Available colors: 100

Bison
 VVYDBISON(C) (1 Yard).....\$64.00/yd. 
 VV1/2YDBISON(C) (1/2 Yard).....\$32.00/ea.
 Available colors: 100, 204, 314, 510, 606, 610

Coachman
 VVYDCOACHMAN(C) (1 Yard).....\$64.00/yd. 
 VV1/2YDCOACHMAN(C) (1/2 Yard).....\$32.00/ea.
 Available colors: 100, 130, 140, 200, 330, 338, 340, 432, 434, 452, 528, 540, 550, 560, 640, 650, 656, 664, 666, 670

Cologne
 VVYDCOLOGNE(C) (1 Yard).....\$64.00/yd. 
 VV1/2YDCOLOGNE(C) (1/2 Yard).....\$32.00/ea.
 Available colors: 100, 102, 10A, 202, 318, 320, 332, 414, 420, 430, 520, 526, 614, 620, 636

Doeskin
 VVYDDOESKIN(C) (1 Yard).....\$64.00/yd. 
 VV1/2YDDOESKIN(C) (1/2 Yard).....\$32.00/ea.
 Available colors: 100, 104, 200, 206G, 508G

Dorchester
 VVYDDORCHESTER(C) (1 Yard).....\$64.00/yd. 
 VV1/2YDDORCHESTER(C) (1/2 Yard).....\$32.00/ea.
 Available colors: 100, 202

El Paso
 VVYDELPASO(C) (1 Yard).....\$64.00/yd. 
 VV1/2YDELPASO(C) (1/2 Yard).....\$32.00/ea.
 Available colors: 100, 200

Krinkle
 VVYDKRINKLE(C) (1 Yard).....\$64.00/yd. 
 VV1/2YDKRINKLE(C) (1/2 Yard).....\$32.00/ea.
 Available colors: 100, 154

Madrid
 VVYDMADRID(C) (1 Yard).....\$64.00/yd. 
 VV1/2YDMADRID(C) (1/2 Yard).....\$32.00/ea.
 Available colors: 100G, 202G, 204G, 210G, 220G, 230G, 235G, 239G, 240G, 310G, 325G, 331G, 333G, 334G, 338G, 342G, 343G, 351G, 369G, 380G, 415G, 420G, 421G, 424G, 429G, 448G, 460G, 465G, 469G, 501G, 511G, 513G, 520G, 631G, 635G, 640G, 642G, 645G, 650G, 651G, 657G, 658G, 670G, 679G, 683G, 690G, 694G, 695G, 697G, 709G, 710G

Oxen
 VVYDOXEN(C) (1 Yard).....\$64.00/yd. 
 VV1/2YDOXEN(C) (1/2 Yard).....\$32.00/ea.
 Available colors: 100

Oxford
 VVYDOXFORD(C) (1 Yard).....\$64.00/yd. 
 VV1/2YDOXFORD(C) (1/2 Yard).....\$32.00/ea.
 Available colors: 100, 200, 264, 360, 450

Ranger
 VVYDRANGER(C) (1 Yard).....\$64.00/yd. 
 VV1/2YDRANGER(C) (1/2 Yard).....\$32.00/ea.
 Available colors: 100, 200

Shallow Elk
 VVYDSHALLOWELK(C) (1 Yard).....\$64.00/yd. 
 VV1/2YDSHALLOWELK(C) (1/2 Yard).....\$32.00/ea.
 Available colors: 100, 156, 200, 202G, 230G, 341

Sierra
 VVYDSIERRA(C) (1 Yard).....\$64.00/yd. 
 VV1/2YDSIERRA(C) (1/2 Yard).....\$32.00/ea.
 Available colors: 100G, 102G, 200G, 209G, 319G, 528G, 684G, 688G

1 YARD AND MORE IS SHIPPED OVERSIZED 1

Specialty Grain Vinyl Yardage



All grain/color combinations not listed above can be produced upon request.
 Available in 1/2 yd or 1yd sheets **ONLY**



1/2 Yard (54"x18")
 TTMOLDSMALL.....\$36.00/ea.
 * Need to specify grain and color

1 Yard (54"x36")
 TTMOLDXL.....\$96.00/ea. 
 * Need to specify grain and color



UPHOLSTERY AND TRIM ACCESORIES

 facebook.com/legendaryautointeriors
 twitter.com/legendaryautoin

 www.legendaryautointeriors.com
 instagram.com/legendaryautointeriorsltd
 youtube.com/user/legendaryauto

1964 CUTLASS & 442 HOLIDAY COUPE & CONVERTIBLE

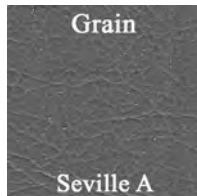

Grain

Seville A

(C) COLOR CODES:

- (100G) Black
- (206G) White
- (325G) Metallic Blue
- (406G) Green
- (508G) Red
- (656G) Brown

Front Buckets **AA64GUD0010(C)**
 (All Colors) \$578/pr.
 ☞ Molded foam is available for this model. Please see the "GM Molded Foam" section in this catalog.

Hardtop Coupe Rear **AA64GUD0040(C)**
 (All Colors) \$340/ea.

Convertible Rear **AA64GUD0050(C)**
 (All Colors) \$340/ea.

Conv Rear Bench Back Panel .. **SK64GA000019(C)**
 (All Colors) \$75/ea.

This Legendary product features as-original heat sealed Seville grain inserts and Seville grain skirts.

1965 CUTLASS & 442 HOLIDAY COUPE & CONVERTIBLE



Grain

Madrid

(C) COLOR CODES:

- (100G) Black
- (210G) White
- (314G) Sterling Blue
- (325G) Metallic Blue
- (528G) Red
- (710G) Buckskin

Front Buckets **AA65GUD0010(C)**
 100G, 210G, 325G,
 528G, 710G \$578/pr.
 314G \$1222/pr. (L1)
 ☞ Molded foam is available for this model.
 Please see the "GM Molded Foam" section in this catalog.

Hardtop Coupe Rear **AA65GUD0040(C)**
 100G, 210G, 325G,
 528G, 710G \$340/ea.
 314G \$965/ea. (L1)

Convertible Rear **AA65GUD0050(C)**
 100G, 210G, 325G,
 528G, 710G \$340/ea.
 314G \$965/ea. (L1)

Convertible Rear Bench Back Panel **SK65GA000019(C)**
 100G, 210G, 325G,
 528G, 710G \$75/ea.
 314G \$235/ea. (L1)

This Legendary product features as-original Madrid grain inserts and Madrid grain skirts.

1966 CUTLASS & 442 "OEM STYLE" SPORTS COUPE

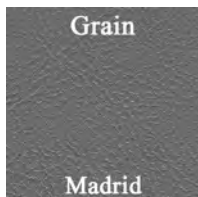

Grain

Madrid

(C) COLOR CODES:

- (100G) Black
- (239G) Metallic Parchment
- (325G) Metallic Blue
- (528G) Red

Front Buckets **AA66GUS0010(C)**
 (All Colors) \$547/pr.
 ☞ Molded foam is available for this model.
 Please see "GM Molded Foam" section in this catalog.
 ☞ Customer must reuse original square center buttons.

Sports Coupe Rear **AA66GUS0047(C)**
 (All Colors) \$308/ea.
 ☞ Customer must reuse original square center buttons.

Headrest Covers **HC66GA00N14(C)**
 (All Colors) \$78/pr.
 Headrest Covers (Zippered) ... **HC66GA00Z14(C)**
 (All Colors) \$97/pr.
 ☞ Non-original replacement covers for factory molded headrests.
 ☞ Professional installation is highly recommended.

This Legendary product features as-original Madrid grain inserts and Madrid grain skirts.



1966 CUTLASS & 442 RALLYE SEAT SPORTS COUPE

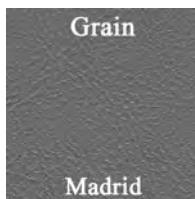

(C) COLOR CODES:
 (100G) Black
 (239G) Metallic Parchment
 (325G) Metallic Blue
 (528G) Red

Front Buckets **RS66GUS0010(C)** 
 (All Colors) \$954/kit
 Kit consists of: 1 pair Rallye Bucket Seat Covers, 1 set Rallye Seat Foam (4 pc.), 1 pair Stretch Panel Boards, 1 yd. Muslin, 30 ft. Listing Wire, 2 yd. Burlap, 9 ft. 2 inch Felt and 1 Dust Mask.

Headrest Covers **HC66GA00N14(C)**
 (All Colors) \$78/pr.
 Headrest Covers (Zippered) ... **HC66GA00Z14(C)**
 (All Colors) \$97/pr.
 Non-original replacement covers for factory molded headrests.
 Professional installation is highly recommended.

This Legendary product features as-original Madrid grain inserts and Madrid grain skirts.

1966 CUTLASS & 442 "OEM STYLE" HOLIDAY COUPE & CONVERTIBLE

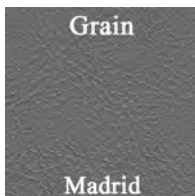

(C) COLOR CODES:
 (100G) Black
 (239G) Metallic Parchment
 (325G) Metallic Blue
 (528G) Red

This Legendary product features as-original Madrid grain inserts and Madrid grain skirts with Madrid grain center accent strip.

Front Buckets **AA66GUD0010(C)**
 (All Colors) \$578/pr.
 Molded foam is available for this model.
 Please see "GM Molded Foam" section in this catalog.

Holiday Coupe Rear **AA66GUD0048(C)**
 (All Colors) \$340/ea.

Convertible Rear **AA66GUD0056(C)**
 (All Colors) \$340/ea.

Convertible Rear Bench Back Panel
 **SK65GA000019(C)**
 (All Colors) \$75/ea.

Headrest Covers **HC66GA00N14(C)**
 (All Colors) \$78/pr.
 Headrest Covers (Zippered) ... **HC66GA00Z14(C)**
 (All Colors) \$97/pr.
 Non-original replacement covers for factory molded headrests.
 Professional installation is highly recommended.

1966 CUTLASS & 442 RALLYE SEAT HOLIDAY COUPE & CONVERTIBLE



(C) COLOR CODES:
 (100G) Black
 (239G) Metallic Parchment
 (325G) Metallic Blue
 (528G) Red

Front Buckets **RS66GUD0010(C)** 
 (All Colors) \$985/kit
 Kit consists of: 1 pair Rallye Bucket Seat Covers, 1 set Rallye Seat Foam (4 pc.), 1 pair Stretch Panel Boards, 1 yd. Muslin, 30 ft. Listing Wire, 2 yd. Burlap, 9 ft. 2 inch Felt and 1 Dust Mask.

Headrest Covers **HC66GA00N14(C)**
 (All Colors) \$78/pr.
 Headrest Covers (Zippered) ... **HC66GA00Z14(C)**
 (All Colors) \$97/pr.
 Non-original replacement covers for factory molded headrests.
 Professional installation is highly recommended.

This Legendary product features as-original Madrid grain inserts and Madrid grain skirts with Madrid grain center accent strip.

**1967 CUTLASS SUPREME & 442 "OEM STYLE"
HOLIDAY COUPE & CONVERTIBLE**

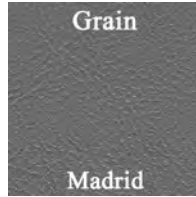

(C) COLOR CODES:

- (100G) Black
- (310G) Light Metallic Blue (Requires Sample Approval)
- (501G) Red
- (640G) Pearl Yellow

This Legendary product features as-original Madrid grain inserts and Madrid grain skirts.

Front Buckets	AA67GUD0010(C)
(All Colors)	\$558/pr.
☞ Molded foam is available for this model. Please see "GM Molded Foam" section in this catalog.	
Holiday Coupe Rear	AA67GUD0048(C)
(All Colors)	\$320/ea.
Convertible Rear	AA67GUD0056(C)
(All Colors)	\$320/ea.
Convertible Rear Bench Back Panel	SK65GA00019(C)
(All Colors)	\$75/ea.
Headrest Covers	HC66GA00N14(C)
(All Colors)	\$78/pr.
Headrest Covers (Zippered) ...	HC66GA00Z14(C)
(All Colors)	\$97/pr.
☞ Non-original replacement covers for factory molded headrests. ☞ Professional installation is highly recommended.	

**1967 CUTLASS SUPREME & 442 RALLYE SEAT
HOLIDAY COUPE & CONVERTIBLE**

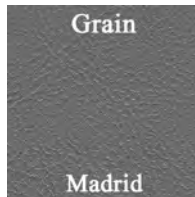

(C) COLOR CODES:

- (100G) Black
- (310G) Light Metallic Blue (Requires Sample Approval)
- (501G) Red
- (640G) Pearl Yellow

This Legendary product features as-original Madrid grain inserts and Madrid grain skirts.

Front Buckets	RS67GUD0010(C)	
(All Colors)	\$971/kit	
☞ Kit consists of: 1 pair Rallye Bucket Seat Covers, 1 set Rallye Seat Foam (4 pc.), 1 pair Stretch Panel Boards, 1 yd. Muslin, 30 ft. Listing Wire, 2 yd. Burlap, 9 ft. 2 inch Felt and 1 Dust Mask.		
Headrest Covers	HC66GA00N14(C)	
(All Colors)	\$78/pr.	
Headrest Covers (Zippered) ...	HC66GA00Z14(C)	
(All Colors)	\$97/pr.	
☞ Non-original replacement covers for factory molded headrests. ☞ Professional installation is highly recommended.		

**1968 CUTLASS, 442 & HURST "OEM STYLE"
SPORTS COUPE, HOLIDAY COUPE & CONVERTIBLE**

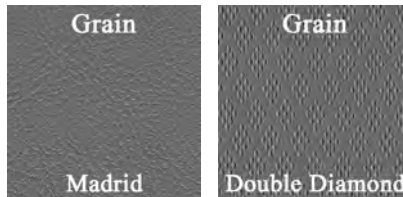

(C) COLOR CODES:

- (100G) Black
- (204G) Metallic Parchment
- (332G) Light Metallic Blue (Requires Sample Approval)
- (333G) Teal Blue
- (502G) Dark Red
- (645G) Willow Gold

This Legendary product features as-original Heat Sealed Double Diamond & Madrid grain inserts and Madrid grain skirts.

Front Buckets	AA68GUS0010(C)
(All Colors)	\$547/pr.
☞ Molded foam is available for this model. Please see the "GM Molded Foam" section in this catalog.	
Holiday & Sports Coupe Rear	AA68GUS0047(C)
(All Colors)	\$308/ea.
Convertible Rear	AA68GUS0056(C)
(All Colors)	\$308/ea.



**1968 CUTLASS, 442 & HURST RALLYE SEAT
SPORTS COUPE, HOLIDAY COUPE & CONVERTIBLE**



NEW!!!

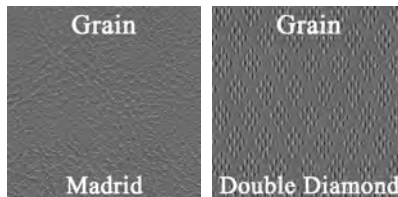

Front Buckets **RS68GUS0010(C)** 
(All Colors) \$954/kit
Kit consists of: 1 pair Rallye Bucket Seat Covers, 1 set Rallye Seat Foam (4 pc.), 1 pair Stretch Panel Boards, 1 yd. Muslin, 30 ft. Listing Wire, 2 yd. Burlap, 9 ft. 2 inch Felt and 1 Dust Mask.

(C) COLOR CODES:
(100G) Black
(204G) Metallic Parchment
(332G) Light Metallic Blue (Requires Sample Approval)
(333G) Teal Blue
(502G) Dark Red
(645G) Willow Gold

This Legendary product features as-original Heat Sealed Double Diamond & Madrid grain inserts and Madrid grain skirts.

**1968 CUTLASS SUPREME "OEM STYLE"
HOLIDAY COUPE**

PHOTO N/A
AT TIME OF
PRINTING

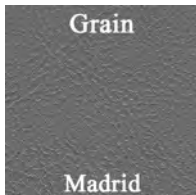

(C) COLOR CODES:
(100G) Black
(204G) Metallic Parchment
(332G) Light Metallic Blue
(Requires Sample Approval)
(502G) Dark Red
(645G) Willow Gold

Front Buckets **AA68GUD0010(C)**
(All Colors) \$614/pr.
Molded foam is available for this model.
Please see the "GM Molded Foam" section in this catalog.

Holiday Coupe Rear
..... **AA68GUD0048(C)**
(All Colors) \$351/ea.

This Legendary product features as-original Madrid grain inserts and Madrid grain skirts

**1968 CUTLASS SUPREME RALLYE SEAT
HOLIDAY COUPE**



NEW!!!

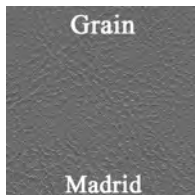

(C) COLOR CODES:
(100G) Black
(204G) Metallic Parchment
(332G) Light Metallic Blue
(Requires Sample Approval)
(502G) Dark Red
(645G) Willow Gold

Front Buckets **RS68GUD0010(C)** 
(All Colors) \$1017/kit
Kit consists of: 1 pair Rallye Bucket Seat Covers, 1 set Rallye Seat Foam (4 pc.), 1 pair Stretch Panel Boards, 1 yd. Muslin, 30 ft. Listing Wire, 2 yd. Burlap, 9 ft. 2 inch Felt and 1 Dust Mask.

This Legendary product features as-original Madrid grain inserts and Madrid grain skirts

**1969 CUTLASS S, 442 & HURST "OEM STYLE"
SPORTS COUPE, HOLIDAY COUPE & CONVERTIBLE**

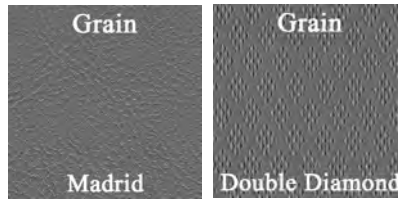

(C) COLOR CODES:

- (100G) Black
- (235G) Parchment
- (325G) Metallic Blue
- (511G) Red
- (635G) Gold

Front Buckets **AA69GUS0010(C)**
(All Colors) \$547/pr.
 ☞ Molded foam is available for this model.
 Please see the "GM Molded Foam" section in this catalog.

Holiday & Sports Coupe Rear
 **AA69GUS0047(C)**
(All Colors) \$308/ea.

Convertible Rear
 **AA69GUS0056(C)**
(All Colors) \$308/ea.

Headrest Covers **HC69GA00014(C)**
(All Colors) \$78/pr.
 ☞ Non-original replacement covers for factory molded headrests.
 ☞ Professional installation is highly recommended.

This Legendary product features as-original Heat Sealed Double Diamond grain inserts and Madrid grain skirts.

**1969 CUTLASS S, 442 & HURST RALLYE SEAT
SPORTS COUPE, HOLIDAY COUPE & CONVERTIBLE**



(C) COLOR CODES:

- (100G) Black
- (235G) Parchment
- (325G) Metallic Blue
- (511G) Red
- (635G) Gold

Front Buckets **RS69GUS0010(C)** ^{OS2}
(All Colors) \$954/kit
 ☞ Kit consists of: 1 pair Rallye Bucket Seat Covers, 1 set Rallye Seat Foam (4 pc.), 1 pair Stretch Panel Boards, 1 yd. Muslin, 30 ft. Listing Wire, 2 yd. Burlap, 9 ft. 2 inch Felt and 1 Dust Mask.

**ACCORDING TO
RIDLEY...
BELIEVE IT!!**



This Legendary product features as-original Heat Sealed Double Diamond grain inserts and Madrid grain skirts.

**1969 CUTLASS SUPREME "OEM STYLE"
HOLIDAY COUPE**

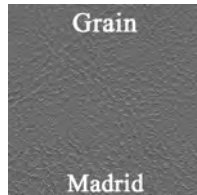

(C) COLOR CODES:

- (100G) Black
- (235G) Parchment
- (325G) Metallic Blue
- (511G) Red
- (635G) Gold

Front Buckets **AA69GUD0010(C)**
(All Colors) \$613/pr.
 ☞ Molded foam is available for this model.
 Please see the "GM Molded Foam" section in this catalog.

Holiday Coupe Rear
 **AA69GUD0048(C)**
(All Colors) \$352/ea.

Headrest Covers **HC69GA00014(C)**
(All Colors) \$78/pr.
 ☞ Non-original replacement covers for factory molded headrests.
 ☞ Professional installation is highly recommended.

This Legendary product features as-original Madrid grain inserts and Madrid grain skirts



**1969 CUTLASS SUPREME RALLYE SEAT
HOLIDAY COUPE**



NEW!!!

Front Buckets **RS69GUD0010(C)** ⁰⁵²
(All Colors) \$1017/kit
⚠ Kit consists of: 1 pair Rallye Bucket Seat Covers,
1 set Rallye Seat Foam (4 pc.), 1 pair Stretch Panel
Boards, 1 yd. Muslin, 30 ft. Listing Wire, 2 yd. Burlap,
9 ft. 2 inch Felt and 1 Dust Mask.

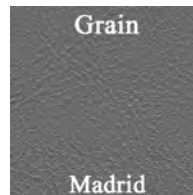

(C) COLOR CODES:
(100G) Black
(235G) Parchment
(325G) Metallic Blue
(511G) Red
(635G) Gold

This Legendary product features as-original Madrid grain inserts and Madrid grain skirts

**1970 CUTLASS S, 442 & RALLYE 350 "OEM STYLE"
SPORTS COUPE & HOLIDAY COUPE**



(C) COLOR CODES:
(100G) Black
(202G) Pearl White
(310G) Light Metallic Blue
(460G) Metallic Green
(650G) Gold

Front Buckets **AA70GUS0010(C)**
(All Colors) \$578/pr.
⚠ Molded foam is available for this model.
Please see the "GM Molded Foam" section in
this catalog.

Sports Coupe Rear **AA70GUS0047(C)**
(All Colors) \$329/ea.

Holiday Coupe Rear ... **AA70GUS0048(C)**
(All Colors) \$329/ea.

Headrest Covers **HC69GA00014(C)**
(All Colors) \$78/pr.
⚠ Non-original replacement covers for factory
molded headrests.
⚠ Professional installation is highly recommended.

This Legendary product features as-original Pigskin grain inserts and Madrid grain skirts with buttons.

**1970 CUTLASS S, 442 & RALLYE 350 RALLYE SEAT
SPORTS COUPE & HOLIDAY COUPE**



NEW!!!

Front Buckets **RS70GUS0010(C)** ⁰⁵²
(All Colors) \$985/kit
⚠ Kit consists of: 1 pair Rallye Bucket Seat Covers,
1 set Rallye Seat Foam (4 pc.), 1 pair Stretch Panel
Boards, 1 yd. Muslin, 30 ft. Listing Wire, 2 yd. Burlap,
9 ft. 2 inch Felt and 1 Dust Mask.

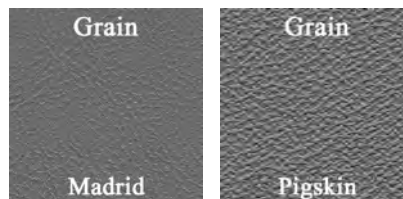

(C) COLOR CODES:
(100G) Black
(202G) Pearl White
(310G) Light Metallic Blue
(460G) Metallic Green
(650G) Gold

This Legendary product features as-original Pigskin grain inserts and Madrid grain skirts with buttons.

1970 CUTLASS SUPREME & 442 "OEM STYLE" HOLIDAY COUPE & CONVERTIBLE

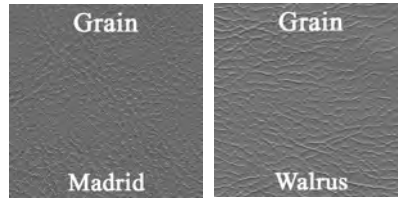

(C) COLOR CODES:

- (100G) Black
- (202G) Pearl White
- (310G) Light Metallic Blue
- (460G) Metallic Green
- (650G) Gold
- (658G) Burnished Saddle

Front Buckets **AA70GUD0010(C)**
(All Colors) \$578/pr.
 ☞ Molded foam is available for this model.
 Please see the "GM Molded Foam" section in this catalog.

Holiday Coupe Rear... **AA70GUD0048(C)**
(All Colors).....\$329/ea.
 ☞ Cutlass Supreme models only.

Convertible Rear.....**AA70GUD0056(C)**
(All Colors).....\$329/ea.

Headrest Covers.....**HC69GA00014(C)**
(All Colors).....\$78/pr.
 ☞ Non-original replacement covers for factory molded headrests.
 ☞ Professional installation is highly recommended.

This Legendary product features as-original Walrus grain inserts and Madrid grain skirts with button tufted upper insert.

1970 CUTLASS SUPREME & 442 RALLYE SEAT HOLIDAY COUPE & CONVERTIBLE



(C) COLOR CODES:

- (100G) Black
- (202G) Pearl White
- (310G) Light Metallic Blue
- (460G) Metallic Green
- (650G) Gold
- (658G) Burnished Saddle

Front Buckets **RS70GUD0010(C)** 
(All Colors) \$985/kit
 ☞ Kit consists of: 1 pair Rallye Bucket Seat Covers, 1 set Rallye Seat Foam (4 pc.), 1 pair Stretch Panel Boards, 1 yd. Muslin, 30 ft. Listing Wire, 2 yd. Burlap, 9 ft. 2 inch Felt and 1 Dust Mask.

This Legendary product features as-original Walrus grain inserts and Madrid grain skirts with button tufted upper insert.

1971 CUTLASS SUPREME & 442 "OEM STYLE" HARDTOP COUPE & CONVERTIBLE

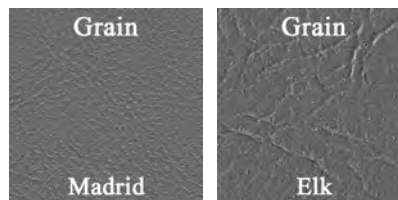

(C) COLOR CODES:

- (100G) Black
- (202G) Pearl White
- (380G) Blue
- (415G) Jade Green
- (657G) Sienna

Front Buckets **AA71GUD0010(C)**
(All Colors)..... \$558/pr.
 ☞ Molded foam is available for this model.
 Please see the "GM Molded Foam" section in this catalog.

Hardtop Coupe Rear ... **AA71GUD0048(C)**
(All Colors).....\$320/ea.
 ☞ Cutlass Supreme models only.

Convertible Rear..... **AA71GUD0056(C)**
(All Colors)..... \$320/ea.
 ☞ 380G Blue was not available in convertible models with bucket seats.

Headrest Covers..... **HC69GA00014(C)**
(All Colors)..... \$78/pr.
 ☞ Non-original replacement covers for factory molded headrests.
 ☞ Professional installation is highly recommended.

This Legendary product features as-original Elk grain inserts and Madrid grain skirts



**1971 CUTLASS SUPREME & 442 RALLYE SEAT
HARDTOP COUPE & CONVERTIBLE**



NEW!!!

Front Buckets **RS71GUD0010(C)** 
 (All Colors)..... \$971/kit
 Kit consists of: 1 pair Rallye Bucket Seats, 1 set Rallye Seat Foam (4 pc.), 1 pair Stretch Panel Boards, 1 yd. Muslin, 30 ft. Listing Wire, 2 yd. Burlap, 9 ft. 2 inch Felt and 1 Dust Mask.

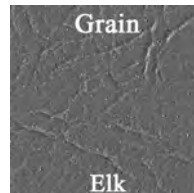
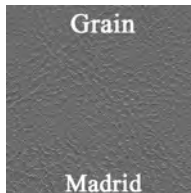

(C) COLOR CODES:

- (100G) Black
- (202G) Pearl White
- (380G) Blue
- (415G) Jade Green
- (657G) Sienna

This Legendary product features as-original Elk grain inserts and Madrid grain skirts

**1971 CUTLASS S & 442 "OEM STYLE"
SPORTS COUPE & HARDTOP COUPE**

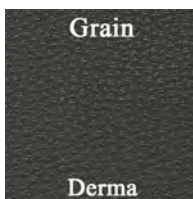

(C) COLOR CODES:

- (100G) Black
- (202G) Pearl White
- (380G) Blue
- (415G) Jade Green
- (657G) Sienna

Front Buckets **AA71GUS0010(C)**
 (All Colors) \$578/pr.
 Molded foam is available for this model.
 Please see the "GM Molded Foam" section in this catalog.

Hardtop/Sports Coupe Rear
 **AA71GUS0048(C)**
 (All Colors)..... \$329/ea.

Headrest Covers..... **HC69GA00014(C)**
 (All Colors)..... \$78/pr.
 Non-original replacement covers for factory molded headrests.
 Professional installation is highly recommended.

This Legendary product features as-original Derma grain inserts and Madrid grain skirts with buttons.

**1971 CUTLASS S & 442 RALLYE SEAT
SPORTS COUPE & HARDTOP COUPE**



NEW!!!

Front Buckets **RS71GUS0010(C)** 
 (All Colors) \$985/kit
 Kit consists of: 1 pair Rallye Bucket Seats, 1 set Rallye Seat Foam (4 pc.), 1 pair Stretch Panel Boards, 1 yd. Muslin, 30 ft. Listing Wire, 2 yd. Burlap, 9 ft. 2 inch Felt and 1 Dust Mask.

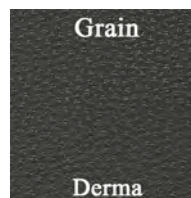
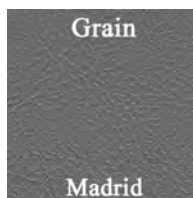

(C) COLOR CODES:

- (100G) Black
- (202G) Pearl White
- (380G) Blue
- (415G) Jade Green
- (657G) Sienna

This Legendary product features as-original Derma grain inserts and Madrid grain skirts with buttons.

**1972 CUTLASS SUPREME, 442 & HURST "OEM STYLE"
HARDTOP COUPE & CONVERTIBLE**

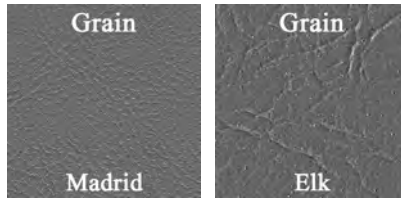

(C) COLOR CODES:

- (100G) Black
- (230G) White
- (380G) Blue
- (465G) Green
- (690G) Saddle

Front Buckets **AA71GUD0010(C)**
(All Colors)..... \$558/pr.
 ☞ Molded foam is available for this model.
 Please see the "GM Molded Foam" section in this catalog.

Hardtop Coupe Rear ... **AA72GUD0048(C)**
(All Colors)..... \$320/ea.
 ☞ Cutlass Supreme models only.

Convertible Rear..... **AA72GUD0056(C)**
(All Colors)..... \$320/ea.
 ☞ 380G Blue and 465G Green were not available in convertible models with bucket seats.

Headrest Covers..... **HC69GA00014(C)**
(All Colors)..... \$78/pr.
 ☞ Non-original replacement covers for factory molded headrests.
 ☞ Professional installation is highly recommended.

This Legendary product features as-original Elk grain inserts and Madrid grain skirts

**1972 CUTLASS SUPREME, 442 & HURST RALLYE SEAT
HARDTOP COUPE & CONVERTIBLE**

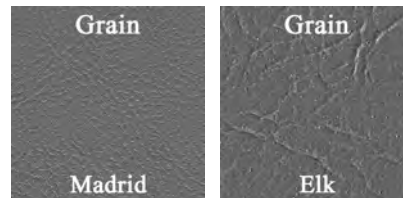

(C) COLOR CODES:

- (100G) Black
- (230G) White
- (380G) Blue
- (465G) Green
- (690G) Saddle

Front Buckets **RS71GUD0010(C)** 
(All Colors)..... \$971/kit
 ☞ Kit consists of: 1 pair Rallye Bucket Seats, 1 set Rallye Seat Foam (4 pc.), 1 pair Stretch Panel Boards, 1 yd. Muslin, 30 ft. Listing Wire, 2 yd. Burlap, 9 ft. 2 inch Felt and 1 Dust Mask.

This Legendary product features as-original Elk grain inserts and Madrid grain skirts

**1972 CUTLASS S & 442 "OEM STYLE"
SPORTS COUPE & HARDTOP COUPE**

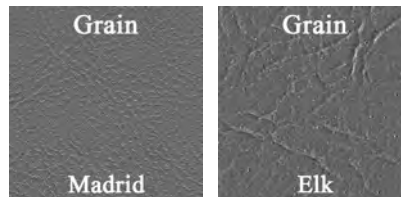

(C) COLOR CODES:

- (100G) Black
- (230G) White
- (380G) Blue
- (465G) Green
- (690G) Saddle

Front Buckets **AA72GUS0010(C)**
(All Colors) \$578/pr.
 ☞ Molded foam is available for this model.
 Please see the "GM Molded Foam" section in this catalog.

Hardtop/Sports Coupe Rear
 **AA72GUS0048(C)**
 \$329/ea.

Headrest Covers..... **HC69GA00014(C)**
(All Colors)..... \$78/pr.
 ☞ Non-original replacement covers for factory molded headrests.
 ☞ Professional installation is highly recommended.

This Legendary product features as-original Elk grain inserts and Madrid grain skirts with buttons.



**1972 CUTLASS S & 442 RALLYE SEAT
SPORTS COUPE & HARDTOP COUPE**



NEW!!!

Front Buckets **RS72GUS0010(C)** 
 (All Colors)\$985/kit
 Kit consists of: 1 pair Rallye Bucket Seats, 1 set Rallye Seat Foam (4 pc.), 1 pair Stretch Panel Boards, 1 yd. Muslin, 30 ft. Listing Wire, 2 yd. Burlap, 9 ft. 2 inch Felt and 1 Dust Mask.

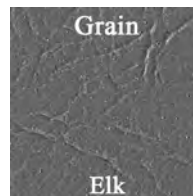
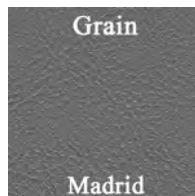

(C) COLOR CODES:

- (100G) Black
- (230G) White
- (380G) Blue
- (465G) Green
- (690G) Saddle

This Legendary product features as-original Elk grain inserts and Madrid grain skirts with buttons.

**1966 F-85, CUTLASS & 442
SPORTS COUPE & HOLIDAY COUPE**

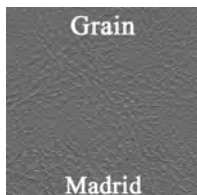

(C) COLOR CODES:

- (100G) Black
- (325G) Metallic Blue
- (528G) Red

Front Split Bench...**AA66GUS0020(C)**
 (All Colors) \$547/ea.
 Customer must reuse original square center buttons.

Holiday & Sports Coupe Rear
**AA66GUS0047(C)**
 (All Colors)\$308/ea.
 Customer must reuse original square center buttons.

Headrest Covers....**HC66GA00014(C)**
 (All Colors).....\$78/pr.

This Legendary product features as-original Madrid grain inserts and Madrid grain skirts.

**1966 CUTLASS & 442
HOLIDAY COUPE & CONVERTIBLE**

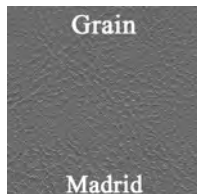

(C) COLOR CODES:

- (100G) Black
- (521G) Metallic Bronze

Front Split Bench with Center Armrest
**AA66GUD0030(C)**
 100G..... \$599/ea.
 521G.....\$1208/ea.
 Please specify carpet color of stretch panel at time of order.

Holiday Coupe Rear
**AA66GUD0048(C)**
 100G.....\$340/ea.
 521G.....\$896/ea.

Convertible Rear
**AA66GUD0056(C)**
 100G..... \$340/ea.
 521G..... \$896/ea.

Headrest Covers...**HC66GA00014(C)**
 100G.....\$78/pr.
 521G.....\$153/pr.

This Legendary product features as-original Madrid grain inserts and Madrid grain skirts.

1967 CUTLASS SUPREME & 442 HARDTOP COUPE & CONVERTIBLE

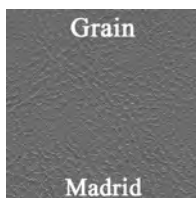

- (C) COLOR CODES:**
 (100G) Black
 (240G) Parchment
 (425G) Turquoise
 (Cutlass Supreme 4-Dr Holiday Sedan only)
 (515G) Burgundy
 (Cutlass Supreme 4-Dr Holiday Sedan only)

- Front Split Bench with Center Armrest
 **AA67GUD0030(C)**
 (All Colors) \$578/ea.
 ☞ Please specify carpet color of stretch panel at time of order.
 ☞ Will also fit Cutlass Supreme 4-Door Holiday Sedan models with a bench seat and center armrest.
 ☞ 425G Turquoise and 515G Burgundy were available in Cutlass Supreme 4-Door Holiday Sedan models only.
- Holiday Coupe Rear
 **AA67GUD0048(C)**
 (All Colors) \$320/ea.
 ☞ Will not fit Cutlass Supreme 4-Door Holiday Sedan models.
- Convertible Rear
 **AA67GUD0056(C)**
 (All Colors) \$320/ea.
- Headrest Covers **HC66GA00014(C)**
 (All Colors) \$78/pr.

This Legendary product features as-original Madrid grain inserts and Madrid grain skirts.

1967 CUTLASS & 442 SPORTS COUPE & CONVERTIBLE

PHOTO N/A
AT TIME OF
PRINTING

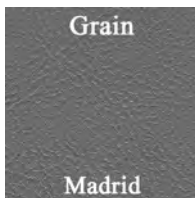

- (C) COLOR CODES:**
 (100G) Black
 (240G) Parchment
 (378G) NOS Dark Blue/NOS Light Blue
 (439G) NOS Dark Turquoise/NOS Light Turquoise
 (507G) Dark Red/Red
 (640G) Pearl Yellow

- Front Split Bench with Center Armrest
 **AA67GUS0020(C)**
 100G, 240G, 507G, 640G \$547/ea.
 378G \$1219/ea. (L1)
 439G \$1219/ea. (L1)
- Sports Coupe Rear
 **AA67GUS0048(C)**
 100G, 240G, 507G \$384/ea.
 378G \$1130/ea. (L1)
 439G \$1130/ea. (L1)
- Convertible Rear
 **AA67GUS0060(C)**
 100G, 507G, 640G \$384/ea.
 378G \$1130/ea. (L1)

This Legendary product features as-original Madrid grain inserts and Madrid grain skirts.

1968 F-85 CLUB COUPE

PHOTO N/A
AT TIME OF
PRINTING



- (C) COLOR CODES:**
 (100G) Black
 (204G) Metallic Parchment
 (428G) Metallic Turquoise / Light Turquoise

- Front Split Bench
 **AA68GU00020(C)**
 (All Colors) \$547/ea.
- Holiday & Sports Coupe Rear
 **AA68GU00080(C)**
 (All Colors) \$308/ea.

This Legendary product features as-original Heat-Sealed Basketweave grain inserts and Madrid grain skirts.



1968 CUTLASS & 442 SPORTS COUPE, HOLIDAY COUPE & CONVERTIBLE



Front Split Bench AA68GUS0020(C) (All Colors).....\$547/ea.
Holiday & Sports Coupe Rear AA68GUS0047(C) (All Colors).....\$308/ea.
Convertible Rear AA68GUS0056(C) (All Colors).....\$308/ea.

(C) COLOR CODES:
 (100G) Black
 (204G) Metallic Parchment
 (332G) Light Metallic Blue
 (Requires Sample Approval)

This Legendary product features as-original Heat-Sealed Double Diamond and Madrid grain inserts and Madrid grain skirts.

1968 CUTLASS SUPREME HOLIDAY COUPE

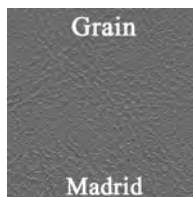

Front Split Bench with Center Armrest AA68GUD0030(C) (All Colors).....\$639/ea. <small>☞ Please specify carpet color of stretch panel at time of order.</small> <small>☞ Will also fit Cutlass Supreme 4dr. Holiday Sedan with a bench seat and center armrest.</small> <small>☞ 502G Dark Red available in Cutlass Supreme 4dr. Holiday Sedan models only.</small>
Holiday Coupe Rear AA68GUD0048(C) (All Colors).....\$351/ea. <small>☞ Will <u>not</u> fit Cutlass Supreme 4dr. Holiday Sedan models.</small>

(C) COLOR CODES:
 (100G) Black
 (204G) Metallic Parchment
 (333G) Teal
 (502G) Dark Red

This Legendary product features as-original Madrid grain inserts and Madrid grain skirts.

1969 CUTLASS S & 442 SPORTS COUPE, HOLIDAY COUPE & CONVERTIBLE



Front Split Bench AA69GUS0020(C) (All Colors).....\$547/ea.
Holiday & Sports Coupe Rear AA69GUS0047(C) (All Colors).....\$308/ea.
Convertible Rear AA69GUS0056(C) (All Colors).....\$308/ea. <small>☞ 432G Light Metallic Green was not available in Cutlass S and 442 convertible models.</small>
Headrest Covers HC69GA00N14(C) (All Colors).....\$78/pr.

(C) COLOR CODES:
 (100G) Black
 (235G) Parchment
 (325G) Metallic Blue
 (432G) Light Metallic Green
 (635G) Gold

This Legendary product features as-original Heat-Sealed Double Diamond grain inserts and Madrid grain skirts.

1969 CUTLASS SUPREME HOLIDAY COUPE



Heat sealed "Cutlass Supreme" logo

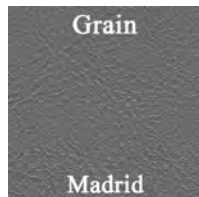

(C) COLOR CODES:
 (100G) Black
 (235G) Parchment
 (432G) Light Metallic Green

Front Split Bench with Center Armrest
**AA69GUD0030(C)**
 (All Colors).....\$639/ea.
 ⚠ Center armrest sold separately.
 ⚠ Please specify carpet color of stretch panel at time of order.
 ⚠ Will also fit Cutlass Supreme 4dr. Holiday Sedan with a bench seat and center armrest.

Center Armrest Cover
**CR69GUD0013(C)**
 (All Colors).....\$56/ea.
 ⚠ Center armrest must be purchased to complete front split bench upholstery.

Holiday Coupe Rear
**AA69GUD0048(C)**
 (All Colors).....\$352/ea.
 ⚠ Will not fit Cutlass Supreme 4dr. Holiday Sedan models.

Headrest Covers...**HC69GA00N14(C)**
 (All Colors).....\$78/pr.

This Legendary product features as-original Madrid and Madrid grain inserts and Madrid grain skirts with buttons and Heat Sealed Cutlass Supreme logo Center Armrest.

1970 F-85 & RALLYE 350 SPORTS COUPE



(C) COLOR CODES:
 (100G) Black
 (310G) Light Metallic Blue
 (460G) Metallic Green
 (650G) Gold
 (694G) Sandalwood (Requires Sample Approval)

Front Split Bench**AA70GU00020(C)**
 (All Colors).....\$680/ea.

Sports Coupe Rear
**AA70GU00088(C)**
 (All Colors).....\$415/ea.

Headrest Covers.....**HC70GA00014(C)**
 (All Colors).....\$78/pr.

This Legendary product features as-original Walrus grain inserts and Madrid grain skirts.

1970 CUTLASS S, 442 & RALLYE 350 SPORTS COUPE & HOLIDAY COUPE



(C) COLOR CODES:
 (100G) Black
 (202G) Pearl White
 (460G) Metallic Green

Front Split Bench**AA70GUS0028(C)**
 (All Colors).....\$578/ea.

Sports Coupe Rear....**AA70GUS0047(C)**
 (All Colors).....\$329/ea.

Holiday Coupe Rear...**AA70GUS0048(C)**
 (All Colors).....\$329/ea.

Headrest Covers.....**HC70GA00014(C)**
 (All Colors).....\$78/pr.

This Legendary product features as-original Pigskin grain inserts and Madrid grain skirts with buttons.



OLDSMOBILE MODEL IDENTIFICATION

From 1964-1972 Oldsmobile offered the F-85, Cutlass, Cutlass S, Cutlass Supreme and 442 in (4) different 2-door models: Club Coupe, Sports Coupe, Holiday Coupe & Convertible. Shown is the basic identification for these models. Please note the difference between the Club & Sports Coupe (also known as a "pillared" coupe) and the Holiday Coupe model.

*1966 models shown in diagram

F-85 Holiday Coupe
Cutlass Holiday Coupe
Cutlass Supreme Holiday Coupe
442 Holiday Coupe

*NOTE: NO Post between door glass and rear quarter glass



F-85 Club Coupe
Cutlass Sports Coupe
Cutlass Supreme Sports Coupe
442 Sports Coupe

*NOTE: Post between door glass and rear quarter glass



Cutlass Convertible
Cutlass Supreme Convertible
442 Convertible



1970 CUTLASS SUPREME & 442 HOLIDAY COUPE & CONVERTIBLE

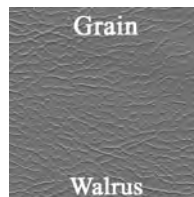
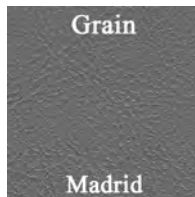

(C) COLOR CODES:
(100G) Black
(202G) Pearl White
(310G) Light Metallic Blue
(460G) Metallic Green
(650G) Gold
(658G) Burnished Saddle

Front Split Bench with Center Armrest
..... **AA70GUD0030(C)**
(All Colors)..... \$599/ea.
☞ Please specify carpet color of stretch panel at time of order.

Holiday Coupe Rear **AA70GUD0048(C)**
(All Colors).....\$329/ea.
☞ Cutlass Supreme models only.

Convertible Rear....**AA70GUD0056(C)**
(All Colors).....\$329/ea.

Headrest Covers....**HC70GA00014(C)**
(All Colors).....\$78/pr.

This Legendary product features as-original Walrus grain inserts and Madrid grain skirts with button tufted upper insert.

1970 CUTLASS SUPREME HOLIDAY COUPE "CLOTH STYLE"

PHOTO N/A
AT TIME OF
PRINTING

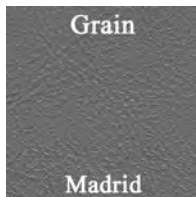

(C) COLOR CODES:
(113G) Black Cloth / Black
(313G) Blue Cloth / Lt Met Blue
(461G) Green Cloth / Green
(653G) Gold Cloth / Gold

(C) HEADREST COLOR CODES:
(100G) Black
(310G) Light Metallic Blue
(460G) Metallic Green
(650G) Gold

Front Split Bench with Center Armrest
.....**AA70GUDC030(C)**
(All Colors)..... \$1098/ea. (L1)
☞ Please specify carpet color of stretch panel at time of order.

Holiday Coupe Rear...**AA70GUDC080(C)**
(All Colors).....\$778/ea. (L1)

Headrest Covers.....**HC70GA00014(C)**
(All Colors).....\$78/pr.

This Legendary product features as-original Cloth inserts and Madrid grain skirts with tufted upper insert.

1971 CUTLASS HARDTOP COUPE

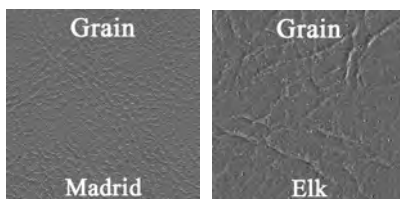

(C) COLOR CODES:

- (100G) Black
- (202G) Pearl White
- (415G) Jade Green
- (657G) Sienna

Front Split Bench.....**AA71GU00028(C)**
(All Colors).....\$680/ea.

Hardtop Coupe Rear
.....**AA71GU00080(C)**
(All Colors).....\$415/ea.

Headrest Covers.....**HC70GA00014(C)**
(All Colors).....\$78/pr.

This Legendary product features as-original Elk grain inserts and Madrid grain skirts

1971 CUTLASS S & 442 SPORTS COUPE & HARDTOP COUPE

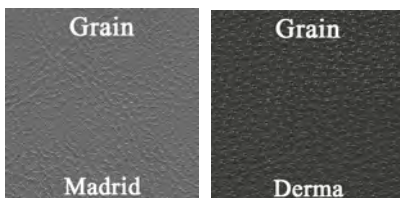

(C) COLOR CODES:

- (100G) Black
- (202G) Pearl White
- (380G) Blue
- (657G) Sienna

Front Split Bench
.....**AA71GUS0020(C)**
(All Colors).....\$578/ea.

Hardtop/Sports Coupe Rear
.....**AA71GUS0048(C)**
(All Colors).....\$329/ea.

Headrest Covers **HC70GA00014(C)**
(All Colors).....\$78/pr.

This Legendary product features as-original Derma grain inserts and Madrid grain skirts with buttons.

1971 CUTLASS SUPREME & 442 HARDTOP COUPE & CONVERTIBLE

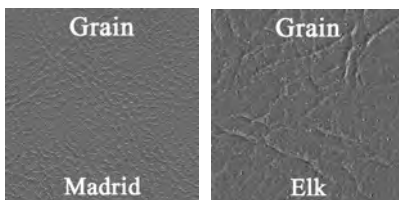

(C) COLOR CODES:

- (100G) Black
- (202G) Pearl White
- (380G) Blue
- (657G) Sienna

Front Split Bench with Center Armrest
.....**AA71GUD0030(C)**
.....\$578/ea.

Please specify carpet color of stretch panel at time of order.

Hardtop Coupe Rear
.....**AA71GUD0048(C)**
(All Colors).....\$320/ea.
Cutlass Supreme models only.

Convertible Rear.....**AA71GUD0056(C)**
(All Colors).....\$320/ea.

Headrest Covers.....**HC70GA00014(C)**
(All Colors).....\$78/pr.

This Legendary product features as-original Elk grain inserts and Madrid grain skirts



**1972 CUTLASS
HARDTOP COUPE**



(C) COLOR CODES:

- (100G) Black
- (230G) White
- (465G) Green
- (690G) Saddle

Front Split Bench.....**AA71GU00028(C)**
(All Colors).....\$680/ea.

Hardtop Coupe Rear
.....**AA72GU00080(C)**
(All Colors).....\$415/ea.

Headrest Covers.....**HC70GA00014(C)**
(All Colors).....\$78/pr.

This Legendary product features as-original Elk grain inserts and Madrid grain skirts

**1972 CUTLASS S & 442
SPORTS COUPE & HARDTOP COUPE**

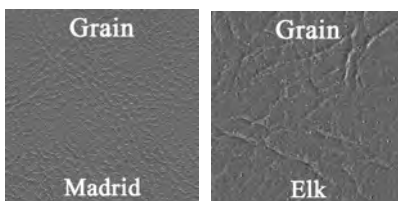

(C) COLOR CODES:

- (100G) Black
- (230G) White
- (465G) Green
- (690G) Saddle

Front Split Bench.... **AA72GUS0020(C)**
(All Colors).....\$578/ea.
Please specify carpet color of stretch panel at time of order.

Hardtop/Sports Coupe Rear
.....**AA72GUS0048(C)**
(All Colors).....\$329/ea.

Headrest Covers.....**HC70GA00014(C)**
(All Colors).....\$78/pr.

This Legendary product features as-original Elk grain inserts and Madrid grain skirts

**1972 CUTLASS SUPREME & 442
HARDTOP COUPE & CONVERTIBLE**

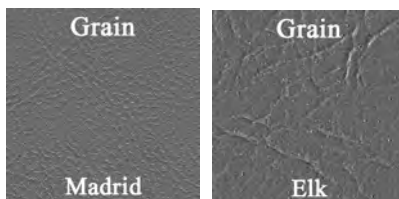

(C) COLOR CODES:

- (100G) Black
- (230G) White
- (690G) Saddle

Front Split Bench with Center Armrest
.....**AA71GUD0030(C)**
(All Colors).....\$578/ea.
Please specify carpet color of stretch panel at time of order.

Hardtop Coupe Rear
.....**AA72GUD0048(C)**
(All Colors).....\$329/ea.
Cutlass Supreme models only.

Convertible Rear..... **AA72GUD0056(C)**
(All Colors).....\$329/ea.

Headrest Covers..... **HC70GA00014(C)**
(All Colors).....\$78/pr.

This Legendary product features as-original Elk grain inserts and Madrid grain skirts

BUCKET SEAT HEADRESTS

Reproduction bucket seat headrests made of molded urethane. Available in black only.



1966-67 Cutlass & 442
HR66GA01\$259.00/pr.

1969 Cutlass & 442
HR69GA01\$229.00/pr.

1970-72 Cutlass & 442
HR70GA01\$229.00/pr.

BUCKET SEAT HEADRESTS BASE TRIM

Plastic base trim piece slides onto the headrest post and mounts to the underside of the headrest



HR68GA-BNH

1968-72 Cutlass & 442
Bench Seat Style

HR68GA-BNH01 (black)\$26.00/pr.

HR68GA-BNH02 (white)\$26.00/pr.

Plastic fasteners NOT INCLUDED

Available in black or white. For colors other than black or white, customer must paint to match their interior color.



HR68GA-BKT

1968-72 Cutlass & 442
Bucket Seat Style

HR68GA-BKT01 (black)\$23.00/pr.

HR68GA-BKT02 (white)\$23.00/pr.

Plastic fasteners NOT INCLUDED

Available in black or white. For colors other than black or white, customer must paint to match their interior color.

1966-67 BUCKET SEAT HEADREST MOUNTING KIT



1966-67 Cutlass & 442
HR66GA-BRACKET\$109.00/pr.

BUCKET SEAT SPRING ASSEMBLY

Reproduction seat assemblies for 1964-72 Cutlass & 442 replace fatigued or broken springs and restore the comfort and support of the originals. Avoid the mistake of restoring your bucket seats without new, properly tensioned seat springs.

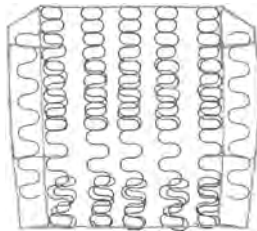

1964-65 Seatback (SA64GA-T)

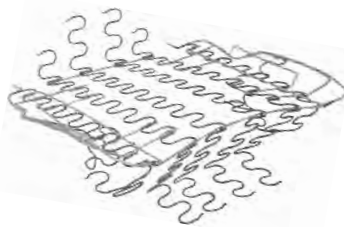

1964-65 Seat bottom (SA64GG-B)

1964-65 Cutlass & 442

SA64GA-T (Seatback) (Shown)\$149.00/ea.

SA64GG-B (Seat bottom) (Shown).....\$149.00/ea.

1966-67 Cutlass & 442

SA66GA-T (Seatback)\$159.00/ea.

SA66GA-B (Seat bottom)\$159.00/ea.

1968-72 Cutlass & 442

SA68GA-T (1968 Seatback)\$159.00/ea.

SA69GA-T (1969-72 Seatback)\$159.00/ea.

SA68GA-B (Seat bottom).....\$159.00/ea.

SEATBACK BUMPERS



BU64GA-BKKIT

BU66GA-BKKIT

Rubber bumpers for 1964-1972 bucket seat models. These bumpers keep the front seat tops in the correct upright position and mount on the backside of the front seat bottoms.

1964-65 Cutlass & 442

BU64GA-BKKIT (screws included).....\$10.00/pr.

These bumpers will also fit most 1964-72 Tempest, LeMans & GTO bench seats.

1966-72 Cutlass & 442

BU66GA-BKKIT (screws included).....\$10.00/pr.

BUCKET SEAT MOUNT CONVERSION BRACKETS



Die-stamped steel brackets allow you to mount bucket seats in 1966-72 models originally equipped with a bench seat.

TA66GA-BRACKET\$39.00/set

(1) set does (2) bucket seat. These brackets are to be welded near the transmission tunnel side so your inside bucket seat tracks can be mounted.

1964-65 BUCKET SEAT CHROME HINGE ROD END CAP



Chrome plated reproduction of the original end caps.

SK64GA-CAP\$5.00/ea.

1969-72 BUCKET HEADREST LOCK ASSEMBLY

Authentic reproduction chrome plated bucket seat headrest locks include the escutcheon and lock as part of the lock assembly. These mount to the bucket front seat tops where the headrest posts slide into the seat.



1969 Cutlass & 442

HR69GA-COVER\$59.00/pr.

1970-72 Cutlass & 442

HR70GA-COVER (shown).....\$49.00/pr.

BUCKET SEATBACK RELEASE BUTTONS

These seat release buttons allow the seatback to fold forward on bucket seat models.



TA67GA-BUTTON

TA69GA-BUTTON

1967-68 Cutlass & 442

SK67GA-BUTTON\$49.00/ea.

1969-72 Cutlass & 442

SK69GA-BUTTON\$39.00/ea.



HOG RING PLIER KITS



Standard Hog Ring Plier Kit

TAHOG\$ 8.00/ea.
 ☞ Kit contains pliers and enough hog rings for a front or rear installation only.

Deluxe Hog Ring Plier Kit

TAHOGHVV (shown).....\$32.00/ea.
 ☞ Kit contains heavy duty pliers and enough hog rings for a complete front and rear installation.

Hog Rings (Pkg/200)

TAHOGRING200.....\$ 5.00/pk.

FOAM & COTTON ACCESSORIES

Cotton Batting (1 Roll)

TACOTTONROLL ⁰⁵².....\$48.00/ea.
 ☞ 1 Roll consists of 13 lbs.

Muslin (1 yard)

TAYDMUSLIN.....\$ 3.00/yd.
 ☞ Must be used with Legendary cotton batting.

High Density Foam

TAFOAM1 (1.5" thick x12" x12")\$20.00/ea.
TAFOAM2 (1.5" thick x 24" x 24")\$38.00/ea.
TAFOAM3 (1.5" thick x 30" x 70") ⁰⁵¹.....\$82.00/ea.

Burlap (36" wide)

TABURLAP.....\$ 3.00/yd.

Paper Coated Wire

TAPAPERWIRE.....\$ 2.50/ft.

SEAT BOTTOM STRETCH PANEL BOARDS

Die-cut seat bottom stretch panel boards for 1965-72 bucket seats. These panel boards attach to the back-side of the bottom seat frame under the upholstery.



1965 Cutlass & 442

SK65GA-PANEL (Bucket seats only) ... \$26.00/pr.

1966-67 GTO, LeMans & Tempest

SK66GA-BNHPANEL (Bench seats only) ..\$35.00/ea.



1966-72 Cutlass & 442

SK66GA-PANEL (Bucket seats only)\$6.00/pr.

SEAT ADJUSTMENT KNOBS



TA64GA-KNOB

TA67GA-KNOB

TA71GA-KNOB

Reproduction seat knobs move the seat forward and back. These will work for both bucket and bench seats. For bucket seats use (2) knobs, for bench seats use (1) knob.

1964-65 Cutlass & 442

TA64GA-KNOB (Chrome).....\$29.00/ea.
 ☞ Will work for 1966 models but fit is slightly different.

1967-70 Cutlass & 442

TA67GA-KNOB (Chrome).....\$10.00/ea.
 ☞ Some 1970 models use black seat knobs. See part # TA70GA-KNOB.

1971-72 Cutlass & 442

TA71GA-KNOB (Black).....\$15.00/ea.

BENCH SEATBACK RELEASE KNOB



This seat release knob allows the seatback to fold forward on bench seat models.

1967-72 Cutlass & 442

TA67GA-BNHKNOB (Chrome).....\$10.00/ea.

1966-72 BUCKET SEATBACKS



Reproduction seatbacks are made of original-style heat-stamped plastic and feature the correct Madrid grain look. Each seatback has been manufactured to original specifications. Chrome beading included.

1966 Cutlass & 442

SK66GA01T (Black)..... discontinued
SK66GA(C)T (Colors)..... discontinued
 ☞ 1966 seatbacks were originally metal.

1968 Cutlass & 442

SK68GA01T (Black).....\$119.00/pr.
SK68GA(C)T (Colors).....\$119.00/pr.
 ☞ Please specify color at time of order.

1969-72 Cutlass & 442

SK69GA01T (Black).....\$119.00/pr.
SK69GA(C)T (Colors).....\$119.00/pr.
 ☞ Please specify color at time of order.

1966-72 BUCKET SEAT BASES



Reproduction lower seat bases are made of original-style heat-stamped plastic and feature the correct Madrid grain look. Chrome beading included. Please specify color at time of order.

☞ (1) pair = (1) seat, (2) pairs required for (2) seats.
 ☞ Please specify color at time of order.
 ☞ 1966-67 seat bases were originally metal.

1966-67 Cutlass & 442

SK66GA01B (Black).....\$99.00/pr.
SK66GA(C)B (Colors).....\$99.00/pr.

1968 Cutlass & 442

SK68GA01B (Black).....\$99.00/pr.
SK68GA(C)B (Colors).....\$99.00/pr.

1969-72 Cutlass & 442

SK69GA01B (Black).....\$99.00/pr.
SK69GA(C)B (Colors).....\$99.00/pr.

1966 COLOR CODES (C)

- | | |
|------------|------------------|
| (01) Black | (04) Turquoise |
| (02) White | (10) Bright Blue |
| (03) Red | (18) Light Blue |

1967 COLOR CODES (C)

- | | |
|------------|------------------|
| (01) Black | (04) Turquoise |
| (02) White | (10) Bright Blue |
| (03) Red | (18) Light Blue |

1968 COLOR CODES (C)

- | | |
|------------------|--------------------------|
| (01) Black | (18) Light Blue |
| (03) Red | (204) Metallic Parchment |
| (11) Medium Blue | |

1969-72 COLOR CODES (C)

- | | |
|------------------|--------------------------|
| (01) Black | (27) Light Saddle |
| (02) White | (29) Dark Saddle |
| (03) Red | (38) Sandalwood |
| (07) Dark Blue | (235) Parchment |
| (10) Bright Blue | (239) Metallic Parchment |
| (13) Dark Green | |

1966-72 BUCKET SEAT CHROME TRIM & "BULLET" END CAPS







Chrome Trim
SK66GA-CHR\$29.00/set

"Bullet" End Caps
SK66GA-CAP (Set/12).....\$29.00/set



MOLDED FOAM AND FOAM ACCESORIES

 facebook.com/legendaryautointeriors
 twitter.com/legendaryautoin

 www.legendaryautointeriors.com
 instagram.com/legendaryautointeriorsltd
 youtube.com/user/legendaryauto

ORIGINAL REPRODUCTION SEAT FOAM

Don't put new seat covers over old deteriorated foam cushions! With these A.C.I. "Quality Replacements," you will enjoy the appearance and comfort of factory new again in your Cutlass and 442. These A.C.I. original reproduction foam kits feature their exclusive cold cure molding process and a limited lifetime guarantee.



1964-65 BUCKET SEAT FOAM

Molded foam for 1964-65 Cutlass and 442 models with bucket seats. Sets consist of a pair of (2) front seat tops and (2) front seat bottoms.



American Cushion Industries
Precision Molded Seat Cushions

MF62GASETAC

\$359.00/set

Professional installation is highly recommended. Please see our installation services shown on this page.

1966-67 BUCKET SEAT FOAM

Molded foam for 1966-67 Cutlass, Cutlass Supreme and 442 models with bucket seats. Sets consist of a pair of (2) front seat tops and (2) front seat bottoms.



American Cushion Industries
Precision Molded Seat Cushions

MF66GASETAC

\$359.00/set

Professional installation is highly recommended. Please see our installation services shown on this page.

1968 BUCKET SEAT FOAM (CUTLASS SUPREME)

Molded foam for 1968 Cutlass Supreme models with bucket seats. Sets consist of a pair of (2) front seat tops and (2) front seat bottoms.



American Cushion Industries
Precision Molded Seat Cushions

MF67GASETAC

\$359.00/set

Professional installation is highly recommended. Please see our installation services shown on this page.

1968-72 BUCKET SEAT FOAM

Molded foam for 1968-72 Cutlass, Cutlass 'S', 442 and 1969-72 Cutlass Supreme models with bucket seats. Sets consist of a pair of (2) front seat tops and (2) front seat bottoms.



American Cushion Industries
Precision Molded Seat Cushions

MF71GASETAC

\$359.00/set

Professional installation is highly recommended. Please see our installation services shown on this page.

1966-70 BENCH SEAT FOAM

Molded foam for 1966-70 Cutlass and 442 models with bench seats. Sets consist of (1) front seat top and (1) front seat bottom.



MF66GA-BENCH

\$379.00/set

Professional installation is highly recommended. Please see our installation services shown on this page.

1971-72 BENCH SEAT FOAM

Molded foam for 1971-72 Cutlass and 442 models with bench seats. Sets consist of (1) front seat top and (1) front seat bottom.



MF71GA-BENCH

\$489.00/set

Professional installation is highly recommended. Please see our installation services shown on this page.

Seat Upholstery Installation Kits NOW AVAILABLE!!!

Seat upholstery Installation Kits from **Legendary** give you the products you need to do the job yourself!! All components are upholstery grade and have been hand selected by our team of installation experts to provide the highest quality materials available.



SEAT INSTALLATION KITS

HARDBTOP AND CONVERTIBLE REAR SEATS

All 1964-72 General Motors A-Body

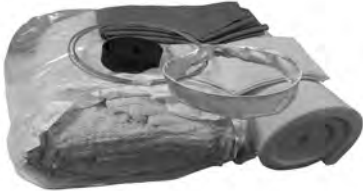

INSTALLATION-KIT2.....\$279.00/ea.
 Kit includes: (1) 30"x70" 1 1/2" thick foam, (1) 10lb. roll of cotton, 4 yards of burlap, 4 yards of paper coated listing wire, 2 yards of muslin, (1) 3 1/2" x 64" Wire Edge Reinforced Burlap Cotton Support Band & a dust mask.

BUCKET FRONT SEATS



Kit 10 - 1964-65

INSTALLATION-KIT10.....\$89.00/ea.
 Kit includes: (1) 5lb. roll of cotton, 2 yards of burlap, 45 feet of paper coated listing wire, 3 yards of 2 inch wide felt, (1) 3 1/2" x 64" Wire Edge Reinforced Burlap Cotton Support Band a dust mask & Side Hinge Felt.

BUCKET FRONT SEATS

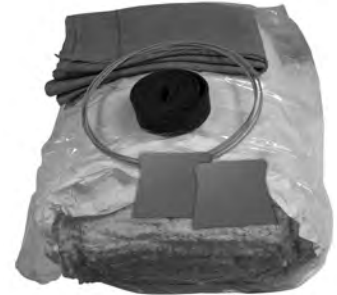

Kit 3 - 1966-72

INSTALLATION-KIT3.....\$69.00/ea.
 Kit includes: (1) 5lb. roll of cotton, 2 yards of burlap, 45 feet of paper coated listing wire, 3 yards of 2 inch wide felt, (2) stretch panel boards & a dust mask.

SPLIT BENCH & FULL BENCH FRONT SEATS



All 1964-72 General Motors A-Body
 *With & Without Center Armrest





INSTALLATION-KIT4.....\$279.00/ea.
 Kit includes: (1) 30"x70" 1 1/2" thick foam, (1) 10lb. roll of cotton, 4 yards of burlap, 4 yards of paper coated listing wire, 2 yards of muslin, 3 yards of 2 inch wide felt, (1) 3 1/2" x 64" Wire Edge Reinforced Burlap Cotton Support Band & a dust mask.



DOOR PANEL AND TRIM ACCESORIES

 facebook.com/legendaryautointeriors
 twitter.com/legendaryautoin

 www.legendaryautointeriors.com
 instagram.com/legendaryautointeriorsltd
 youtube.com/user/legendaryauto

**1964 CUTLASS & 442
HOLIDAY COUPE & CONVERTIBLE**



(C) COLOR CODES:
 (100G) Black
 (206G) White
 (325G) Metallic Blue
 (406G) Green
 (508G) Red
 (656G) Brown

Front Panels (*Holiday Coupe*)
 **DO64GUD0010(C)**
 (All Colors)..... \$383/pr.
 ☞ Please refer to carpet color selection page to specify carpet color at time of order.
 ☞ Customer must reuse original metal trim.

Rear Panels (*Holiday Coupe*)
 **DO64GUD0040(C)**
 (All Colors)..... \$168/pr.

Armrest/Well Covers (*Holiday Coupe*)
 **AW64GA00048(C)**
 (All Colors)..... \$78/pr.

Rear Panels (*Convertible*)
 **DO64GUD0050(C)**
 (All Colors)..... \$168/pr.

Armrest/Well Covers (*Convertible*)
 **AW64GA00056(C)**
 (All Colors)..... \$96/pr.

This Legendary product features as-original Die-electrically heat sealed Seville A grain vinyl with chrome accents and carpeted lower section. Special cutout area in filler board to accommodate armrest base. Padded Multi-Level Construction 3-Dimensional Panel. NOTE: Customer must reuse original decorative trim and medallions. Medallions are available. See following section of catalog.

**1965 CUTLASS & 442
HOLIDAY COUPE & CONVERTIBLE**

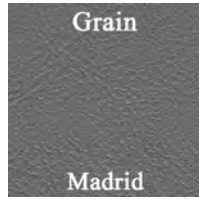

(C) COLOR CODES:
 (100G) Black
 (210G) White
 (314G) Sterling Blue
 (325G) Metallic Blue
 (528G) Red
 (710G) Buckskin

Front Panels (*Holiday Coupe*)
 **DO65GUD0010(C)**
 100G, 210G, 325G, 528G, 710G \$356/pr.
 314G \$718/pr. (L1)
 ☞ Please refer to carpet color selection page to specify carpet color at time of order.
 ☞ Customer must reuse original metal trim.

Rear Panels (*Holiday Coupe*)
 **DO65GUD0040(C)**
 100G, 210G, 325G, 528G, 710G \$168/pr.
 314G \$369/pr. (L1)

Armrest/Well Covers (*Holiday Coupe*)
 **AW65GA00048(C)**
 100G, 210G, 325G, 528G, 710G \$78/pr.
 314G \$174/pr. (L1)

Rear Panels (*Convertible*)
 **DO65GUD0050(C)**
 100G, 210G, 325G, 528G, 710G \$168/pr.
 314G \$369/pr. (L1)

Armrest/Well Covers (*Convertible*)
 **AW65GA00056(C)**
 100G, 210G, 325G,
 528G, 710G \$96/pr.
 314G \$214/pr.

This Legendary product features as-original Die-electrically heat sealed Madrid grain vinyl with carpeted lower section. Special cutout area in filler board to accommodate armrest base. Padded Multi-Level Construction 3-Dimensional Panel.

NOTE: Customer must reuse original decorative trim and medallions. Medallions are available. See following section of catalog.

**1966 F-85, CUTLASS & 442
SPORTS COUPE & HOLIDAY COUPE BUCKET & BENCH STYLE**

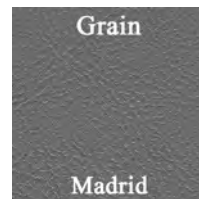

(C) COLOR CODES:
 (100G) Black
 (239G) Metallic Parchment
 (325G) Metallic Blue
 (416G) Metallic Turquoise
 (528G) Red
 (631G) Metallic Gold

Front Panels (*Holiday & Sports Coupe*)
 **DO66GUS0012(C)**
 (All Colors) \$439/pr.
 ☞ Please refer to carpet color selection page to specify carpet color at time of order.
 ☞ Customer must reuse original metal trim.
 ☞ 416G Metallic Turquoise & 631G Metallic Gold were available in models with cloth bench seats only.

Rear Panels (*Holiday & Sports Coupe*)
 **DO66GUS0048(C)**
 (All Colors) \$232/ea.
 ☞ 416G Metallic Turquoise & 631G Metallic Gold were available in models with cloth bench seats only.

Armrest/Well Covers
 **AW65GA00048(C)**
 (All Colors)..... \$78/pr.
 ☞ 416G Metallic Turquoise & 631G Metallic Gold were available in models with cloth bench seats only.

This Legendary product features as-original Die-electrically heat sealed Madrid grain vinyl with upper woodgrain and carpeted lower section. Special cutout area in filler board to accommodate armrest base. Padded Multi-Level Construction 3-Dimensional Panel.

NOTE: Customer must reuse original decorative trim and medallions. Medallions are available. See following section of catalog.



**1966 CUTLASS & 442
HOLIDAY COUPE & CONVERTIBLE BUCKET & BENCH STYLE**

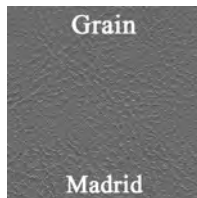

(C) COLOR CODES:

- (100G) Black
- (239G) Metallic Parchment
- (325G) Metallic Blue
- (521G) Metallic Bronze
- (528G) Red

Front Panels (Holiday Coupe & Conv.)	DO66GUD0012(C)
100G, 239G, 325, 528G...	\$356/pr.
521G	\$718/pr.
☞ Please refer to carpet color selection page to specify carpet color at time of order.	
☞ Customer must reuse original metal trim.	

Rear Panels Holiday Coupe	DO66GUD0048(C)
Convertible	DO66GUD0056(C)
100G, 239G, 325, 528G...	\$168/pr.
521G	\$369/pr.

Armrest/Well Covers (Holiday Coupe)	AW65GA00048(C)
100G, 239G, 325, 528G...	\$78/pr.
521G	\$174/pr.

Armrest/Well Covers (Convertible)	AW66GA00056(C)
100G, 239G, 325, 528G...	\$96/pr.
521G	\$214/pr.

This Legendary product features as-original Die-electrically heat sealed Madrid grain vinyl with carpeted lower section. Special cutout area in filler board to accommodate armrest base. Padded Multi-Level Construction 3-Dimensional Panel.

NOTE: Customer must reuse original decorative trim and medallions. Medallions are available. See following section of catalog.

**1967 CUTLASS SUPREME & 442
HOLIDAY COUPE & CONVERTIBLE BUCKET & BENCH STYLE**

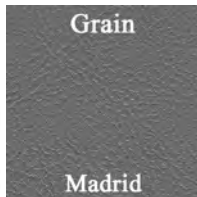

(C) COLOR CODES:

- (100G) Black
- (240G) Parchment
- (310G) Light Metallic Blue
(Requires Sample Approval)
- (501G) Red
- (640G) Pearl Yellow

Front Panels (Holiday Coupe & Conv.)	DO67GUD0012(C)
(All Colors)	\$401/pr.

☞ Please refer to carpet color selection page to specify carpet color at time of order.

☞ Customer must reuse original metal trim.

Rear Panels Holiday Coupe	DO67GUD0048(C)
Convertible	DO67GUD0056(C)
(All Colors)	\$232/pr.

Armrest/Well Covers (Holiday Coupe)	AW65GA00048(C)
(All Colors)	\$78/pr.

Armrest/Well Covers (Convertible)	AW66GA00056(C)
(All Colors)	\$96/pr.

This Legendary product features as-original Die-electrically heat sealed Madrid grain vinyl with carpeted lower section. Special cutout area in filler board to accommodate armrest base. Padded Multi-Level Construction 3-Dimensional Panel.

NOTE: Customer must reuse original decorative trim and medallions. Medallions are available. See following section of catalog.

**1967 CUTLASS SUPREME & 442
SPORTS COUPE & CONVERTIBLE BUCKET & BENCH STYLE**



(C) COLOR CODES:

- (100G) Black
- (240G) Parchment
- (378G) NOS Dk Blue/NOS Lt Blue
- (439G) NOS Dk Turquoise/NOS Lt Turquoise
- (507G) Dark Red/Red
- (640G) Pearl Yellow

Front Panels (Holiday Coupe & Conv.)	DO67GUS0012(C)
100G, 240G, 507G, 640G ..	\$475/pr.
378G	\$765/pr. (L1)
439G	\$765/pr. (L1)

☞ Please refer to carpet color selection page to specify carpet color at time of order.

☞ Customer must reuse original metal trim.

Rear Panels Holiday Coupe	DO67GUS0048(C)
100G, 240G, 507G, 640G ..	\$256/pr.
378G	\$338/pr. (L1)
439G	\$338/pr. (L1)

Armrest/Well Covers (Convertible)	AW66GA00056(C)
(All Colors)	\$96/pr.

This Legendary product features as-original Die-electrically heat sealed Madrid grain vinyl with carpeted lower section. Special cutout area in filler board to accommodate armrest base. Padded Multi-Level Construction 3-Dimensional Panel.

NOTE: Customer must reuse original decorative trim and medallions. Medallions are available. See following section of catalog.

1968 CUTLASS, 442 & HURST SPORTS COUPE, HOLIDAY COUPE & CONVERTIBLE BUCKET & BENCH STYLE

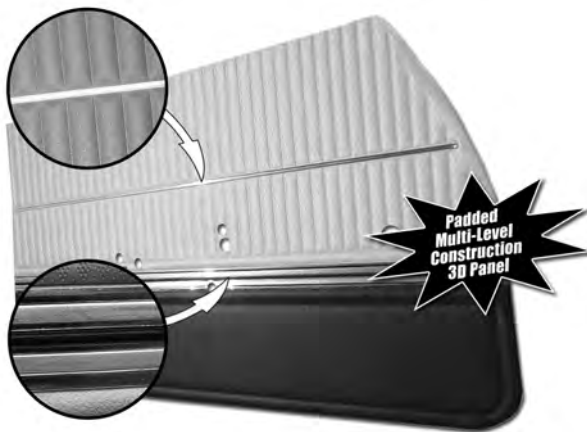

This Legendary product features as-original Die-electrically heat sealed Double Diamond grain upper section with Madrid grain lower section and chrome accent strip. Special cutout area in filler board to accommodate armrest base. Padded Multi-Level Construction 3-Dimensional Panel.

NOTE: Customer must reuse original decorative trim and medallions. Medallions are available. See following section of catalog.



- (C) COLOR CODES:**
- (100G) Black
 - (201G) Parchment/Black
 - (204G) Parchment
(Convertible Rear Only)
 - (332G) Metallic Blue
(Convertible Rear Only)
(Requires Sample Approval)
 - (329G) 332G Metallic Blue/
331G Dark Blue
(Requires Sample Approval)
 - (333G) Teal Blue
 - (502G) Dark Red
 - (645G) Willow Gold

Front Panels (Holiday Coupe & Conv.) (Unassembled).....	DO68GUS0012(C)	\$459/pr.
(Pre-assembled)	DO68GUS0012(C)-PA	\$605/pr.
Front Panels (Sports Coupe) (Unassembled).....	DO68GUS0011(C)	\$459/pr.
(Pre-assembled)	DO68GUS0011(C)-PA	\$638/pr.
Rear Panels (Holiday Coupe) (Unassembled).....	DO68GUS0046(C)	\$317/pr.
(Pre-assembled)	DO68GUS0046(C)-PA	\$510/pr.
Rear Panels (Sports Coupe) (Unassembled).....	DO68GUS0047(C)	\$317/pr.
(Pre-assembled)	DO68GUS0047(C)-PA	\$542/pr.
Rear Panels (Convertible) (Unassembled).....	DO68GUS0056(C)	\$317/pr.
(Pre-assembled)	DO68GUS0056(C)-PA	\$510/pr.
Armrest/Well Covers (Convertible)	AW68GA00056(C)	\$96/pr.

1968 CUTLASS SUPREME HOLIDAY COUPE BUCKET & BENCH STYLE



- (C) COLOR CODES:**
- (100G) Black
 - (204G) Metallic Parchment
 - (332G) Light Metallic Blue
(Requires Sample Approval)
 - (333G) Teal Blue
 - (502G) Dark Red
 - (645G) Willow Gold

This Legendary product features as-original Die-electrically heat sealed Madrid grain vinyl with carpeted lower section. Special cutout area in filler board to accommodate armrest base. Padded Multi-Level Construction 3-Dimensional Panel.

NOTE: Customer must reuse original decorative trim and medallions. Medallions are available. See following section of catalog.

Front Panels (Holiday Coupe) (Unassembled).....	DO68GUD0012(C)	\$459/pr.
(Pre-assembled)	DO68GUD0012(C)-PA	\$675/pr.
Please refer to carpet color selection page to specify carpet color at time of order.		
Rear Panels (Holiday Coupe) (Unassembled).....	DO68GUD0048(C)	\$317/pr.
Rear Panels (Holiday Coupe) (Pre-assembled)	DO68GUD0048(C)-PA	\$510/pr.
Armrest/Well Covers (Holiday Coupe)	AW68GA00048(C)	\$78/pr.

1969 CUTLASS SUPREME HOLIDAY COUPE BUCKET & BENCH STYLE

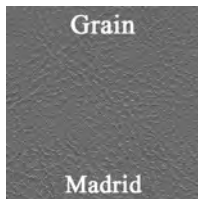

- (C) COLOR CODES:**
- (100G) Black
 - (235G) Parchment
 - (325G) Metallic Blue
 - (432G) Light Metallic Green
 - (511G) Red
 - (635G) Gold

Front Panels (Holiday Coupe) (Unassembled).....	DO69GUD0012(C)	\$459/pr.
(Pre-assembled)	DO69GUD0012(C)-PA	\$675/pr.
Please refer to carpet color selection page to specify carpet color at time of order.		
Rear Panels (Holiday Coupe) (Unassembled).....	DO69GUD0048(C)	\$317/pr.
Rear Panels (Holiday Coupe) (Pre-assembled)	DO69GUD0048(C)-PA	\$510/pr.
Armrest/Well Covers (Holiday Coupe)	AW68GA00048(C)	\$78/pr.

This Legendary product features as-original Die-electrically heat sealed Madrid grain upper section with buttons and carpeted lower section. Special cutout area in filler board to accommodate armrest base. Padded Multi-Level Construction 3-Dimensional Panel.

NOTE: Customer must reuse original decorative trim and medallions. Medallions are available. See following section of catalog.



1969 CUTLASS S, 442 & HURST SPORTS COUPE, HOLIDAY COUPE & CONVERTIBLE BUCKET & BENCH STYLE

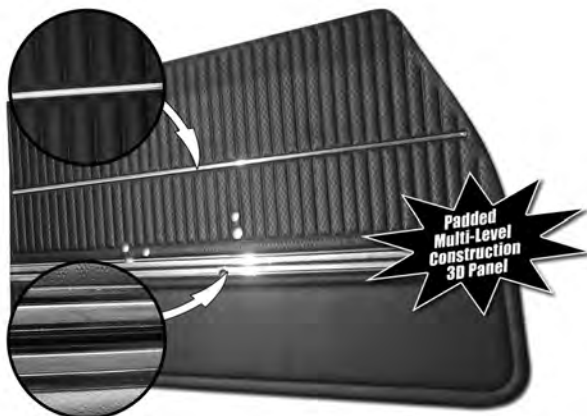

(C) COLOR CODES:

- (100G) Black
- (235G) Parchment
(Convertible Rear Only)
- (241G) Parchment/Black
- (325G) Metallic Blue
(Convertible Rear Only)
- (326G) Metallic Blue/Dark Blue
- (432G) Light Metallic Green
- (511G) Red
- (635G) Gold

This Legendary product features as-original Die-electrically heat sealed Double Diamond grain upper section with Madrid grain lower section and chrome accent strip. Special cutout area in filler board to accommodate armrest base. Padded Multi-Level Construction 3-Dimensional Panel.

NOTE: Customer must reuse original decorative trim and medallions. Medallions are available. See following section of catalog.

Front Panels (Holiday Coupe & Conv.) (Unassembled)	DO69GUS0012(C)
.....	\$459/pr.
(Pre-assembled) ⁰⁵¹	DO69GUS0012(C)-PA
.....	\$605/pr.
Front Panels (Sports Coupe) (Unassembled)	DO69GUS0011(C)
.....	\$459/pr.
(Pre-assembled) ⁰⁵¹	DO69GUS0011(C)-PA
.....	\$638/pr.
Rear Panels (Holiday Coupe) (Unassembled)	DO68GUS0046(C)
.....	\$317/pr.
(Pre-assembled) ⁰⁵¹	DO68GUS0046(C)-PA
.....	\$510/pr.
Rear Panels (Sports Coupe) (Unassembled)	DO68GUS0047(C)
.....	\$317/pr.
(Pre-assembled) ⁰⁵¹	DO68GUS0047(C)-PA
.....	\$542/pr.
Rear Panels (Convertible) (Unassembled)	DO68GUS0056(C)
.....	\$317/pr.
(Pre-assembled) ⁰⁵¹	DO68GUS0056(C)-PA
.....	\$510/pr.
⁰⁵¹ 432G Light Metallic Green was not available in Cutlass S and 442 convertible models.	
Armrest/Well Covers (Convertible)	AW68GA00056(C)
.....	\$96/pr.

1969 CUTLASS S & 442 SPORTS COUPE & HOLIDAY COUPE CLOTH BUCKET & BENCH STYLE

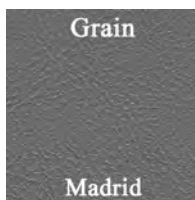
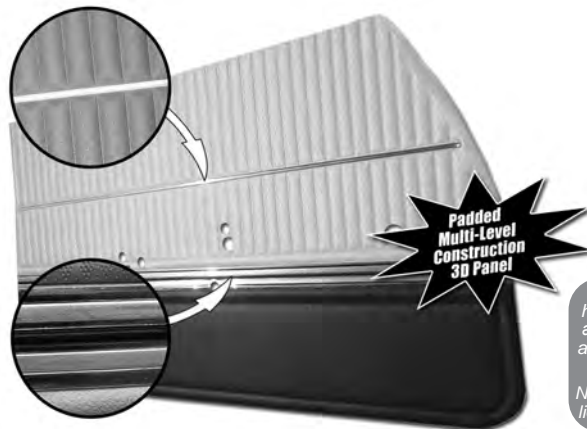

(C) COLOR CODES:

- (326G) Met. Blue/Dk. Blue
- (635G) Gold

This Legendary product features as-original Die-electrically heat sealed Madrid grain vinyl with Madrid grain lower section and chrome accent strip. Special cutout area in filler board to accommodate armrest base. Padded Multi-Level Construction 3-Dimensional Panel.

NOTE: Customer must reuse original decorative trim and medallions. Medallions are available. See following section of catalog.

Front Panels (Holiday Coupe) (Unassembled)	DO69GUS0028(C)
.....	\$459/pr.
(Pre-assembled) ⁰⁵¹	DO69GUS0028(C)-PA
.....	\$605/pr.
Front Panels (Sports Coupe) (Unassembled)	DO69GUS0020(C)
.....	\$459/pr.
(Pre-assembled) ⁰⁵¹	DO69GUS0020(C)-PA
.....	\$638/pr.
Rear Panels (Holiday Coupe) (Unassembled)	DO69GUS0080(C)
.....	\$317/pr.
(Pre-assembled) ⁰⁵¹	DO69GUS0080(C)-PA
.....	\$510/pr.
Rear Panels (Sports Coupe) (Unassembled)	DO69GUS0088(C)
.....	\$317/pr.
(Pre-assembled) ⁰⁵¹	DO69GUS0088(C)-PA
.....	\$542/pr.

1970 CUTLASS S, 442 & RALLYE 350 SPORTS COUPE & HOLIDAY COUPE BUCKET & BENCH STYLE

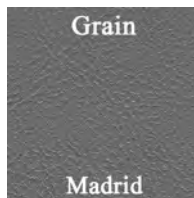

(C) COLOR CODES:

- (100G) Black
- (202G) Pearl White
- (310G) Light Metallic Blue
- (460G) Metallic Green
- (650G) Gold

This Legendary product features as-original Die-electrically heat sealed Madrid grain vinyl with Pigskin grain upper insert, burl woodgrain, chrome accents and carpeted lower section. Special cutout area in filler board to accommodate armrest base. Padded Multi-Level Construction 3-Dimensional Panel.

NOTE: Customer must reuse original decorative trim and medallions. Medallions are available. See following section of catalog.

Front Panels (Holiday Coupe) (Unassembled)	DO70GUS0012(C)
.....	\$459/pr.
(Pre-assembled) ⁰⁵¹	DO70GUS0012(C)-PA
.....	\$605/pr.
Front Panels (Sports Coupe) (Unassembled)	DO70GUS0011(C)
.....	\$459/pr.
(Pre-assembled) ⁰⁵¹	DO70GUS0011(C)-PA
.....	\$638/pr.
Rear Panels (Holiday Coupe) (Unassembled)	DO70GUS0048(C)
.....	\$317/pr.
(Pre-assembled) ⁰⁵¹	DO70GUS0048(C)-PA
.....	\$510/pr.
Rear Panels (Sports Coupe) (Unassembled)	DO70GUS0047(C)
.....	\$317/pr.
(Pre-assembled) ⁰⁵¹	DO70GUS0047(C)-PA
.....	\$542/pr.
Armrest/Well Covers (Holiday Coupe)	AW68GA00048(C)
.....	\$78/pr.

1970 F-85 & RALLYE 350 SPORTS COUPE BENCH STYLE



Padded Multi-Level Construction 3D Panel

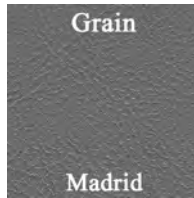

(C) COLOR CODES:

- (100G) Black
- (310G) Light Metallic Blue
- (460G) Metallic Green
- (650G) Gold
- (694G) Sandalwood

Front Panels (<i>Sports Coupe</i>) (Unassembled)	DO70GU00020(C)	
		\$799/pr.
(Pre-assembled)	DO70GU00020(C)-PA	
		\$1027/pr.
Rear Panels (<i>Sports Coupe</i>) (Unassembled)	DO70GU00088(C)	
		\$590/pr.
Rear Panels (<i>Sports Coupe</i>) (Pre-assembled)	DO70GU00088(C)-PA	
		\$748/pr.

This Legendary product features as-original Die-electrically heat sealed Madrid grain vinyl with raised burlwood grain insert and chrome accent. Special cutout area in filler board to accommodate armrest base. Padded Multi-Level Construction 3-Dimensional Panel.
NOTE: Customer must reuse original decorative trim and medallions. Medallions are available. See following section of catalog.

1970 CUTLASS SUPREME & 442 HOLIDAY COUPE & CONVERTIBLE CLOTH BUCKET & BENCH STYLE



Padded Multi-Level Construction 3D Panel

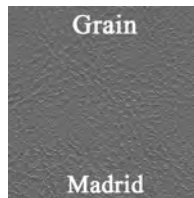

(C) COLOR CODES:

- (100G) Black
- (202G) Pearl White
- (310G) Light Metallic Blue
- (460G) Metallic Green
- (650G) Gold
- (658G) Burnished Saddle

Front Panels (<i>Holiday Coupe & Conv.</i>) (Unassembled)	DO70GUD0012(C)	
		\$459/pr.
(Pre-assembled)	DO70GUD0012(C)-PA	
		\$605/pr.
<small> Please refer to carpet color selection at time of order.</small>		
<small> Customer must provide upper rails.</small>		
Rear Panels (<i>Holiday Coupe</i>) (Unassembled)	DO70GUD0048(C)	
		\$317/pr.
(Pre-assembled)	DO70GUD0048(C)-PA	
		\$510/pr.
Rear Panels (<i>Convertible</i>) (Unassembled)	DO70GUD0056(C)	
		\$317/pr.
(Pre-assembled)	DO70GUD0056(C)-PA	
		\$510/pr.
<small> Customer must provide upper rails.</small>		
Armrest/Well Covers (Hardtop Coupe)	AW68GA00048(C)	
		\$78/pr.
(Convertible)	AW68GA00056(C)	
		\$96/pr.

This Legendary product features as-original Die-electrically heat sealed Madrid grain vinyl with raised Burlwood grain center panel, chrome accent and carpeted lower section. Special cutout area in filler board to accommodate armrest base. Padded Multi-Level Construction 3-Dimensional Panel.

NOTE: Customer must reuse original decorative trim and medallions. Medallions are available. See following section of catalog.

1971 CUTLASS S & 442 SPORTS COUPE & HARDTOP COUPE BUCKET & BENCH STYLE



Padded Multi-Level Construction 3D Panel

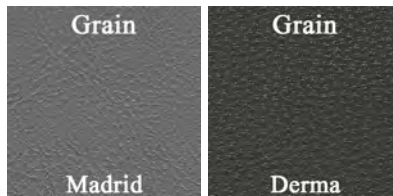

(C) COLOR CODES:

- (100G) Black
- (202G) Pearl White
- (380G) Blue
- (415G) Jade Green
- (657G) Sienna

Front Panels (<i>Hardtop Coupe</i>) (Unassembled)	DO71GUS0012(C)	
		\$459/pr.
(Pre-assembled)	DO71GUS0012(C)-PA	
		\$605/pr.
<small> Please refer to carpet color selection at time of order.</small>		
Rear Panels (<i>Hardtop Coupe</i>) (Unassembled)	DO71GUS0048(C)	
		\$317/pr.
(Pre-assembled)	DO71GUS0048(C)-PA	
		\$510/pr.
Front Panels (<i>Sports Coupe</i>) (Unassembled)	DO71GUS0011(C)	
		\$459/pr.
(Pre-assembled)	DO71GUS0011(C)-PA	
		\$638/pr.
<small> Please refer to carpet color selection at time of order.</small>		
Rear Panels (<i>Sports Coupe</i>) (Unassembled)	DO71GUS0047(C)	
		\$317/pr.
(Pre-assembled)	DO71GUS0047(C)-PA	
		\$542/pr.
Armrest/Well Covers (Htp/Sports Coupe)	AW68GA00048(C)	
		\$78/pr.

This Legendary product features as-original Die-electrically heat sealed Derma and Madrid grain vinyl with raised Walnut woodgrain center panel, chrome accent, buttons and carpeted lower section. Special cutout area in filler board to accommodate armrest base. Padded Multi-Level Construction 3-Dimensional Panel.



1971 CUTLASS SUPREME & 442 HARDTOP COUPE & CONVERTIBLE BUCKET & BENCH STYLE

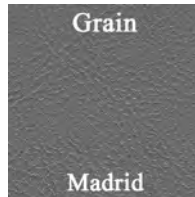
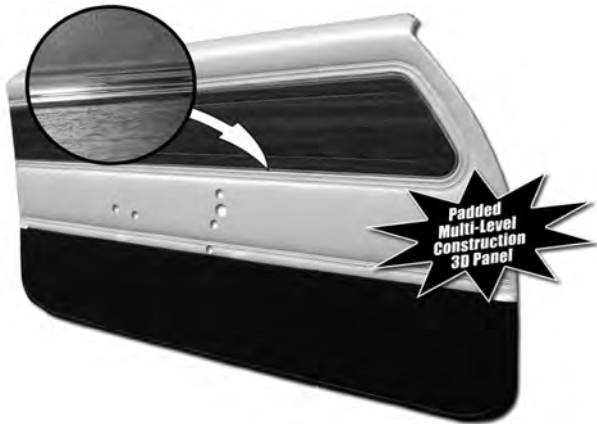

(C) COLOR CODES:
 (100G) Black
 (202G) Pearl White
 (380G) Blue
 (415G) Jade Green
 (657G) Sienna

Front Panels (*Hardtop Coupe & Conv.*)
 (Unassembled) **DO71GUD0012(C)**
 \$459/pr.
 (Pre-assembled) ^{OS1} **DO71GUD0012(C)-PA**
 \$605/pr.
^{ES} Please refer to carpet color selection at time of order.

Rear Panels (*Hardtop Coupe*)
 (Unassembled) **DO71GUD0048(C)**
 \$317/pr.
 (Pre-assembled) ^{OS1} **DO71GUD0048(C)-PA**
 \$510/pr.

Rear Panels (*Convertible*)
 (Unassembled) **DO71GUD0056(C)**
 \$317/pr.
 (Pre-assembled) ^{OS1} **DO71GUD0056(C)-PA**
 \$510/pr.
^{ES} Customer must provide upper rails.

Armrest/Well Covers
 (*Hardtop Coupe*) **AW68GA00048(C)**
 \$78/pr.
 (*Convertible*) **AW68GA00056(C)**
 \$96/pr.

This Legendary product features as-original Die-electrically heat sealed Madrid grain vinyl with raised Walnut woodgrain center panel, chrome accent and carpeted lower section. Special cutout area in filler board to accommodate armrest base. Padded Multi-Level Construction 3-Dimensional Panel.
 NOTE: Customer must reuse original decorative trim and medallions. Medallions are available. See following section of catalog.

1971-72 CUTLASS HARDTOP COUPE BENCH STYLE

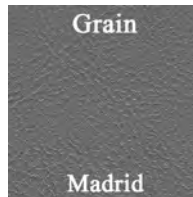

(C) COLOR CODES:
 (100G) Black ('71-'72)
 (202G) Pearl White ('71)
 (230G) White ('72)
 (415G) Jade Green ('71)
 (465G) Green ('72)
 (657G) Sienna ('71)
 (690G) Saddle ('72)

Front Panels (*Hardtop Coupe*)
 (1971) **DO71GU00028(C)**
 (1972) **DO72GU00028(C)**
 (Unassembled) \$799/pr.

(1971) **DO71GU00028(C)-PA**
 (1972) **DO72GU00028(C)-PA**
 (Pre-assembled) ^{OS1} \$1027/pr.
^{ES} Includes original style upper metal rail, door lock ferrules & windowfelt strip.

Rear Panels (*Hardtop Coupe*)
 (1971) **DO71GU00080(C)**
 (1972) **DO72GU00080(C)**
 (Unassembled) \$590/pr.

Rear Panels (*Hardtop Coupe*)
 (1971) **DO71GU00080(C)-PA**
 (1972) **DO72GU00080(C)-PA**
 (Pre-assembled) ^{OS1} \$748/pr.

Armrest/Well Covers (*Hardtop Coupe*)
 **AW68GA00048(C)**
 \$78/pr.

This Legendary product features as-original Die-electrically heat sealed Madrid grain vinyl with raised woodgrain insert (1971 Walnut woodgrain, 1972 Rosewood woodgrain) and chrome accent. Special cutout area in filler board to accommodate armrest base. Padded Multi-Level Construction 3-Dimensional Panel.
 NOTE: Customer must reuse original decorative trim and medallions. Medallions are available. See following section of catalog.

1972 CUTLASS S & 442 SPORTS COUPE & HARDTOP COUPE BUCKET & BENCH STYLE

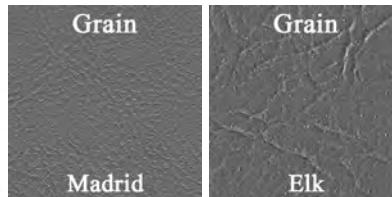

(C) COLOR CODES:
 (100G) Black
 (230G) Pearl White
 (380G) Blue
 (465G) Green
 (690G) Saddle

Front Panels (*Hardtop Coupe*)
 (Unassembled) **DO72GUS0012(C)**
 \$459/pr.
 (Pre-assembled) ^{OS1} **DO72GUS0012(C)-PA**
 \$605/pr.
^{ES} Please refer to carpet color selection at time of order.

Rear Panels (*Hardtop Coupe*)
 (Unassembled) **DO72GUS0048(C)**
 \$317/pr.
 (Pre-assembled) ^{OS1} **DO72GUS0048(C)-PA**
 \$510/pr.

Front Panels (*Sports Coupe*)
 (Unassembled) **DO72GUS0011(C)**
 \$459/pr.
 (Pre-assembled) ^{OS1} **DO72GUS0011(C)-PA**
 \$638/pr.
^{ES} Please refer to carpet color selection at time of order.

Rear Panels (*Sports Coupe*)
 (Unassembled) **DO72GUS0047(C)**
 \$317/pr.
 (Pre-assembled) ^{OS1} **DO72GUS0047(C)-PA**
 \$542/pr.

Armrest/Well Covers
 (*Htp/Sports Coupe*) **AW68GA00048(C)**
 \$78/pr.

This Legendary product features as-original Die-electrically heat sealed Elk and Madrid grain vinyl with raised Rosewood woodgrain center panel, chrome accent, buttons and carpeted lower section. Special cutout area in filler board to accommodate armrest base. Padded Multi-Level Construction 3-Dimensional Panel.

**1972 CUTLASS SUPREME, 442 & HURST
HARDTOP COUPE & CONVERTIBLE BUCKET & BENCH STYLE**

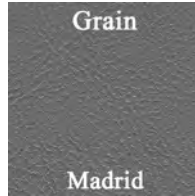

(C) COLOR CODES:

- (100G) Black
- (230G) White
- (380G) Blue
- (465G) Green
- (690G) Saddle

Front Panels (Hardtop Coupe & Conv.)
(Unassembled).....**DO72GUD0012(C)**
.....\$459/pr.
(Pre-assembled) ^{OS1}.....**DO72GUD0012(C)-PA**
.....\$605/pr.
☞ Please refer to carpet color selection at time of order.

Rear Panels (Hardtop Coupe)
(Unassembled).....**DO72GUD0048(C)**
.....\$317/pr.
(Pre-assembled) ^{OS1}.....**DO72GUD0048(C)-PA**
.....\$510/pr.

Rear Panels (Convertible)
(Unassembled).....**DO72GUD0056(C)**
.....\$317/pr.
(Pre-assembled) ^{OS1}.....**DO72GUD0056(C)-PA**
.....\$510/pr.
☞ 380G Blue & 465G Green was not available in a convertible model.
☞ Customer must provide upper rails.

Armrest/Well Covers
(Hardtop Coupe).....**AW68GA00048(C)**
.....\$78/pr.
(Convertible).....**AW68GA00056(C)**
.....\$96/pr.

This Legendary product features as-original Die-electrically heat sealed Madrid grain vinyl with raised Rosewood woodgrain center panel, chrome accent and carpeted lower section. Special cutout area in filler board to accommodate armrest base. Padded Multi-Level Construction 3-Dimensional Panel.

NOTE: Customer must reuse original decorative trim and medallions. Medallions are available. See following section of catalog.

1964-72 ARMREST PADS

Reproduction molded armrest pads are manufactured in the correct grains and texture as the originals. 1964 pads feature Seville grain, while 1965-72 feature authentic Madrid grain. For colors other than black, please specify at time of order.

1964-72 FRONT PADS



**1964-67 F-85, Cutlass & 442
(Sports Coupe & Holiday Coupe)
AP64GA-FRT (1964)**

100G, 206G, 325G, 508G, 656G.....\$101.00/pr.
406G.....\$147.00/pr.

AP65GA-FRT (1965-67)

100G, 210G, 239G, 240G, 310G, 325G, 416G, 501G,
528G, 631G, 640G, 710G.....\$101.00/pr.
314G, 521G.....\$147.00/pr.

☞ These pads measure 11" in length.
☞ Please refer to door panel section for available colors.

**1964-67 Cutlass, Cutlass Supreme & 442
(Holiday Coupe & Convertible)**

AP64GA-FRTH01 (Black) (1964).....\$69.00/pr.
AP65GA-FRTH01 (1965-67).....\$69.00/pr.

☞ These pads measure 13 1/2" in length.

1968-69 Cutlass Supreme (Holiday Coupe)

AP68GKU-FRT01 (Black).....\$159.00/pr.
☞ These pads measure 16" in length.

☞ Available in black only.

**1968-72 Cutlass S & 442 (all models)
1970-72 Cutlass Supreme (all models)**

AP68GA-FRT
100G, 202G, 204G, 230G, 235G, 310G, 325G,
332G, 333G, 380G, 415G, 432G, 460G, 465G,
502G, 511G, 635G, 645G, 650G, 657G, 658G,
690G, 694G.....\$101.00/pr.

☞ These pads measure 11" in length.
☞ Please refer to door panel section for available colors.

1964-72 ARMREST PADS CONT.

1968-69 REAR PADS



**1968-69 Cutlass & 442
1968-69 Tempest, LeMans & GTO
AP68GA-RR**

100G, 204G, 235G, 325G, 332G, 333G, 432G,
502G, 511G, 635G, 645G.....\$92.00/pr.

☞ Please refer to door panel section for available colors.

1964-67 ARMREST BASES

Chrome armrest bases are original-style injection molded plastic. Triple chrome plated, these are of a superior quality than others on the market. Available in pairs for both front and rear.



**1964-67 F-85, Cutlass & 442
(Sports Coupe & Holiday Coupe)**

AP64GA-BASEFRT (Front) (shown)...\$49.00/pr.
☞ Uses 11" armrest pads.

**1964-67 Cutlass, Cutlass Supreme & 442
(Holiday Coupe & Convertible)**

AP64GA-BASEFRTHC (Front).....\$99.00/pr.
☞ Uses 13 1/2" armrest pads.

1964-67 Cutlass & 442

AP64GA-BASERR (Rear).....\$49.00/pr.
☞ Fits all coupe models.

1964-72 REAR ARMREST COVERS

Rear armrest covers for Holiday Coupe, Hardtop Coupe and Convertible models are made in-house to original specifications and feature the correct vinyl colors and grains to match our upholstery. Please specify color at time of order.



COUPE MODELS

**1964 Cutlass & 442
AW64GA00048(C)**.....\$78.00/set
☞ Please see door panel section for available colors.

**1965-67 Cutlass & 442
AW65GA00048(C)**.....\$78.00/set
☞ Please see door panel section for available colors.

**1968-69 Cutlass Supreme
1970-72 Cutlass Supreme
1970-72 Cutlass S & 442
AW68GA00048(C)**.....\$78.00/set
☞ Please see door panel section for available colors.

CONVERTIBLE MODELS

**1964 Cutlass & 442
AW64GA00056(C)**.....\$96.00/set
☞ Please see door panel section for available color.

**1965 Cutlass & 442
AW65GA00056(C)**.....\$96.00/set
☞ Please see door panel section for available colors.

**1966-67 Cutlass & 442
AW66GA00056(C)**.....\$96.00/set
☞ Please see door panel section for available colors.

**1968-72 Cutlass S & 442
1970-72 Cutlass Supreme
AW68GA00056(C)**.....\$96.00/set
☞ Please see door panel section for available colors.



ASHWELL INSTALLATION PAD KITS

Ashwell installation pad kits for 1964-72 Cutlass & 442 Hardtop and Convertible models.



1964-67 Cutlass & 442 (hardtop)

INSTALLATION-AW1\$39.00/kit

Kit includes: (2) 20oz. board w/ 5oz. felt attached, (2) 20oz. felt & (2) 40oz. felt



1968-72 Cutlass & 442 (hardtop)

INSTALLATION-AW3.....\$39.00/kit

Kit includes: (2) 20oz. board w/ 5oz. felt attached, (2) 20oz. felt & (2) 40oz. felt



1964-67 Cutlass & 442 (convertible)

INSTALLATION-AW2.....\$39.00/kit

Kit includes: (2) 20oz. board w/ 5oz. felt attached, (2) 5oz. felt & (2) 20oz. felt



1968-72 Cutlass & 442 (convertible)

INSTALLATION-AW4.....\$39.00/kit

Kit includes: (2) 20oz. board w/ 5oz. felt attached, (2) 5oz. felt & (2) 20oz. felt

1971-72 DOOR PULL STRAP

Reproduction GM A-Body deluxe style door pull handles. Feature correct madrid grain double stitched vinyl wrapped around a pvc core, new spring steel with correct radius bends just like the originals and steel reinforcement bracket that mounts on the backside of the panel. Door pull anchor screw kit and installation instructions included.



**1971-72 Cutlass & 442
DO70GA-HNDL**

100G, 202G, 230G, 310G, 342G, 380G, 415G, 460G, 465G, 650G, 657G, 683G, 690G, 694G, 695G, 697G

.....\$156.00/pr.

Kit includes: Customers must reuse original trim end caps and mounting brackets.

1968-72 ARMREST BASES

High-quality reproduction injection molded plastic bases have the original texture and grain as the originals.



1968-72 Cutlass & 442

AP68GAF-BASELH (Left Front) \$29.00/ea.
AP68GAF-BASERH (Right Front) \$29.00/ea.

1964-72 CONVERTIBLE COURTESY LIGHT LENS & BEZELS



These quality reproduction lens and bezels mount to the rear armrest on convertible models. The lens is reproduced in the correct "eggshell" white while the bezel is manufactured using NOS tooling.

1964-72 Cutlass & 442

LL64GA-CBEZEL (Bezel only)\$29.00/ea.
LL64GA-CLENS (Lens only).....\$10.00/ea.

1969-72 ARMREST BASE CHROME BACK PLATE

Chrome back plates found on some, but not all, 1969-72 models. Factory exact and ready to install. Will not work for 1968 models.



1969-72 Cutlass & 442

AP69GA-BASECHR (Front)\$49.00/pr.

1964-72 ASHTRAYS

These ashtrays are constructed from stainless steel and fit just like the originals. Available for both hardtop and convertible models.



1964-67 Cutlass & 442

AT64GA-C (Hardtop/Convertible)\$59.00/pr.
Kit includes: Bezels included for convertible models.

1968-70 Cutlass & 442

AT68GA-C (Convertible)\$49.00/ea.

1968-72 Cutlass & 442 (shown)

AT68GA-H (Hardtop)\$59.00/ea.

1968-72 ARMREST BASE SCREW SET

These Phillips head sheet metal screws fasten the armrest base to the door. Set of (6).

1968-72 Cutlass & 442

AP68GA-SCREW (Set/6) \$9.00/set

1968-69 STAINLESS ARMREST BASE MOLDING

Factory-correct armrest molding found on some, but not all 1968-69 models.

1968-69 Cutlass & 442

AP68GA-BASETRIM\$49.00/pr.
Kit includes: Holes will need to be drilled on bases for installation.

HINGE TO DOOR BOLTS



Made to exact GM specifications for proper fit.

1968-72 Cutlass & 442

DO68GA-BOLTS.....\$49.00/set

1968-69 DOOR PANEL WINDLACE



Made as original with Madrid grain vinyl, rubber cord and die-cut panel board. This windlace installs on the front edge of the rear quarter panels and is a decorative and functional wind seal.

Made as original for both post, non-post and convertible models. Please specify color at time of order.



1968-69 Cutlass & 442

WI68GA00047(C) (Sports Coupe) \$93.00/pr.
WI68GA00048(C) (Holiday Cpe/Conv) .. \$93.00/pr.

1964-67 UPPER DOOR JAMB END CAPS

Exact reproduction endcaps screw to the upper door jamb and give that finished look by covering the end of the windlace seal. Available in black only.



1964-65 Cutlass & 442

WI64GA-CAPH (Hardtop/Coupe)..... \$39.00/pr.
WI64GA-CAPC (Convertible)..... \$39.00/pr.

1966-67 Cutlass & 442

WI66GA-CAPHC..... \$29.00/pr.
 Fits both hardtop and convertible models.

1964-67 DOOR JAMB WINDLACE



This quality replacement molded windlace features the original bumpy grain vinyl with the steel insert to clip to the door jamb edge lip. Available in black, lt. blue, dk. blue, fawn, saddle, (64) red, (65-67) red and white. Please specify color at time of order.

1964-67 Cutlass & 442

WI64GA(C) (Holiday Coupe)..... \$49.00/pr.
 Will also work for convertible models.

DOOR LOCK KNOBS



Complete your door trim restoration with new door lock knobs. Available in black or chrome.

1964-66 Cutlass & 442

BT64GA (Chrome).....\$15.00/pr.

1967 Cutlass & 442

BT67GA (Chrome w/ "tuliped" head)....\$ 15.00/pr.

1968-72 Cutlass & 442 (shown)

BT68GA (Chrome w/ ribbed shaft).....\$19.00/pr.

1964-67 DOOR PANEL LOWER TRIM MOLDING



Door panel moldings made of extruded aluminum feature stainless steel fold over tabs. These moldings attach to the front of the door panel and cover the area where the lower carpet trim and vinyl meet.

1964-67 Cutlass & 442

TA64GA-TRIMFRT (Front)..... \$49.00/pr.
TA64GA-TRIMRR (Coupe rear)..... \$29.00/pr.

DOOR LOCK FERRULES

Authentically reproduced ferrules support the door lock knob.



BT64GAFERRULE

BT68GAFERRULE

1964-67 Cutlass & 442

BT64GAFERRULE (Clear plastic) \$9.00/pr.

1968-72 Cutlass & 442 (shown)

BT68GAFERRULE (Stainless steel)..... \$2.00/ea.

These ferrules feature the correct inner felt ring as original.

DOOR PANEL CLIPS



Original style door panel installation clips.

1964-72 Cutlass & 442

DOGACLIPS \$14.00/kit

Kit includes 18 clips and 12 trim screws which are enough to install a pair of door and rear quarter panels.

DOOR PANEL CLIP RETAINERS



Plastic retainers fit into the inner door and quarter panel frame to act as anchors for the metal door panel clips.

1964-72 Cutlass & 442

DOGARETAIN (Pkg/12).....\$10.00/pk.



DOOR HANDLES



Chrome reproduction inner door handle for 1964 Sports Coupe & Club Coupe models that use an 11" armrest pad.

1964 F-85, Cutlass & 442
CK64GHU-DOOR\$29.00/ea.



Chrome reproduction inner door handle for 1964-67 Holiday Coupe and Convertible models that use a 13 1/2" armrest pad.

1964-67 Cutlass, Cutlass Supreme & 442
CK64GUK-DOOR\$59.00/pr.



Chrome reproduction inner door handle for 1965-67 Sports Coupe & Club Coupe models that use an 11" armrest pad.

1965-67 F-85, Cutlass & 442
CK65GA-DOOR\$19.00/ea.



Chrome reproduction inner door handles for 1968-72 models.

1968-72 Cutlass & 442
CK68GA-DOORLH (Left).....\$19.00/ea.
CK68GA-DOORRH (Right).....\$19.00/ea.

WINDOW CRANK HANDLES



Die-cast reproduction of the original front and rear window crank handle for all 1964 models.

1964 F-85, Cutlass & 442
CK64GHU-WNDW (Chrome knob)\$19.00/ea.



Die-cast reproduction of the original chrome front and rear window crank handle for all 1965-66 models.

1965-66 F-85, Cutlass & 442
CK65GA-WNDW (Chrome knob).....\$19.00/ea.



Die-cast reproduction of the original chrome front and rear window crank handle for all 1967-72 models.

1967-72 F-85, Cutlass & 442
CK67GA-WNDW01 (Black knob).....\$15.00/ea.
CK67GA-WNDW02 (Clear knob).....\$15.00/ea.

1964-67 VENT WINDOW HANDLES



Duplicated to exact GM specifications with a brilliant chrome finish. These die-cast vent handles come with roll pins and spring washers.

1964-65 Cutlass & 442
CK64GA-VENTLH (Left).....\$29.00/ea.
CK64GA-VENTRH (Right).....\$29.00/ea.

1966-67 Cutlass & 442
CK66GA-VENT\$49.00/pr.

1968-72 VENT WINDOW CRANKS



Reproduction vent window cranks for all 1968 models and 1969-72 Sports Coupe models with vent windows.

1968-72 F-85, Cutlass & 442
CK68GA-VENT01 (Black).....\$19.00/ea.
CK68GA-VENT02 (Clear).....\$19.00/ea.

DOOR & WINDOW HANDLE PLASTIC WASHER



Injection molded plastic washers protect the door panel from wear when door and window handles are being used.

1964-72 Cutlass & 442
CK64GA-SPACER\$3.00/ea.

WINDOW HANDLES SPRINGS



This spring goes behind the window crank handle and plastic washer to prevent vibration and rattling.

1964-72 Cutlass & 442
CK64GA-SPRING\$3.00/ea.

DOOR & WINDOW HANDLE RETAINING CLIP



1964-72 Cutlass & 442
CK64GA-CLIP.....\$1.00/ea.

DOOR LOCK STRIKER



These door strikers feature the same hardened steel as the originals and should be used to replace damaged or fatigued originals.

1964-72 Cutlass & 442 NEW!!!
DO64GA-STRIKER..... \$19.00/ea.

UPPER DOOR HINGES



1966-67

These are OEM-quality hinges and are made to factory specifications. They are fantastic reproductions of the original hinges and they're completely assembled for easy installation.

1966-67 Cutlass & 442 (shown) NEW!!!
DO66GA-HINGEU..... \$59.00/ea.

1968-72 Cutlass & 442 NEW!!!
DO68GA-HINGEU..... \$89.00/ea.

LOWER DOOR HINGES



1966-67

1968-72



These are OEM-quality hinges and are made to factory specifications. They are fantastic reproductions of the original hinges and they're completely assembled for easy installation.

1966-67 Cutlass & 442 NEW!!!
DO66GA-HINGELP (passenger) \$79.00/ea.
DO66GA-HINGELD (driver)..... \$79.00/ea.

1968-72 Cutlass & 442 NEW!!!
DO68GA-HINGELP (passenger) \$89.00/ea.
DO68GA-HINGELD (driver)..... \$99.00/ea.

LOWER DOOR HINGE PINS

Hardened shouldered pivot pins



1964-67

1964-67 Cutlass & 442 NEW!!!
DO64GA-HINGEPIN \$8.00/ea

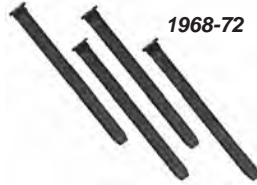

1968-72

1968-72 Cutlass & 442 NEW!!!
DO68GA-HINGEPIN \$10.00/ea

LOWER DOOR SPRING



Direct replacement for missing or broken door hinge springs. Same size and spring rate as original part.

1965-67 Cutlass & 442
DO65GA-SPRING..... \$15.00/ea.

DOOR SILL PLATES



Replace old scratched-up sill plates with a pair of these exact reproductions. Precision manufactured using the correct aluminum and anodized finish featuring the "Body by Fisher" tags.
 * Do not come with screws, must supply own.

1964-67 Cutlass & 442
SP64GA\$79.00/pr.

1968-72 Cutlass & 442
SP68GA\$99.00/pr.

DOOR PANEL EMBLEM



Emblem is chromed and detailed just like the original for a factory look.

1968 Cutlass S NEW!!!
DO68GU-EMBLEM \$19.00/ea.

DOOR PANEL WATERSHIELDS

Die-cut watershields are designed to protect your door panels from moisture. Sold as a complete set of 4 for front and rear panels.

1964-67 Cutlass & 442
DO64GAWATERH (Hardtop)\$37.00/set
DO64GAWATERC (Convertible).....\$37.00/set

1968-72 Cutlass & 442
DO68GAWATERHS (1968-69 Htp Cpe) ..\$37.00/set
DO68GAWATERH (1970-72 Htp Cpe) ..\$37.00/set
DO68GAWATERS (1968-72 Sports Cpe) ..\$37.00/set
DO68GAWATERC (Convertible).....\$37.00/set

SEAT BELT BOLTS



1964-66
 Chrome Plated

1964-66
 Cad Plated

1967-72 Chrome
 Plated

The bolt heads are the factory-sized 13/16" and fit and function just like the originals and come in either a cad-plated or chrome finish.

1964-72 Cutlass & 442 NEW!!!
BA64GA-BOLT (Chrome).....\$15.00/ea.
BA64GA-BOLTC (Cad).....\$15.00/ea.
BA67GA-BOLT (Chrome).....\$15.00/ea.

JUTE BACKING

This insulating material when placed between the floorpan and molded carpet enhances sound barrier protection from road noise and adds cushion to your carpet. Also helpful for insulating headliners, trunk areas and more.





36"x36" cut



TA200ZFELT (20 oz.).....\$10.00/yd.
TA400ZFELT (40 oz.).....\$15.00/yd.





CARPETS, FLOORMATS AND ACCESORIES

 facebook.com/legendaryautointeriors
 twitter.com/legendaryautoin

 www.legendaryautointeriors.com
 instagram.com/legendaryautointeriorsltd
 youtube.com/user/legendaryauto



MODEL SPECIFIC CARPET

Legendary brand molded carpets utilize the heaviest face weight cutpile and loop carpet combined with an extra heavy poly coated backing that provides for an accurate and sharply detailed mold formed area. Surged edges and accurately die cut and applied 40oz. felt underlayment is the finishing touch to our vehicle specific carpets.

Bound and Surged Edges

Both Legendary cutpile and loop molded carpets have a heavy duty bound and surged edge that provides for an easy installation and clean appearance.



Underlayment Padding

Legendary molded carpets are made with a 40 oz. felt underlayment padding. All padding is trimmed around seat track mounts, seat belt holes and covers the most area than any carpet in the industry!



80/20 LOOP CARPET COLOR SELECTOR (c)

01 BLACK	03 RED	04 AQUA	05 DARK TEAL	06 FORD BLUE	07 DARK BLUE	08 TEAL	09 SHADE 13 BLUE
10 BRIGHT BLUE	11 MEDIUM BLUE	12 GREEN	13 DARK GREEN	14 DARK OLIVE GREEN	15 BLUE GREEN	16 MOSS GREEN	21 MEDIUM RED
22 BURNT ORANGE	24 ROSE BEIGE	25 DARK BROWN	26 SADDLE	27 LT/MEDIUM SADDLE	28 DARK COPPER	29 DARK SADDLE	31 MAROON
32 GOLD	33 DARK GOLD	34 FAWN	35 RED TUXEDO	36 BLUE TUXEDO	37 AQUA TUXEDO	38 LIGHT GREEN	39 ORANGE
40 PLUM	41 SUNSET GLOW	42 SILVER MINK	44 CORAL	45 EMBER GLOW	46 IVY GOLD	47 FAWN TUXEDO	48 SILVER
49 GUNMETAL GRAY	50 PARCHMENT	51 MIDNIGHT BLUE	53 GOLD TUXEDO	54 COPPER TUXEDO	55 OLIVE TUXEDO	81 CHARCOAL	

**36oz. JUTE PADDING INCLUDED WHERE PADDING WAS ORIGINAL.

**VINYL BOUND EDGE WHERE THE FRONT AND REAR SECTIONS OF THE CARPET OVERLAP.

**COLOR MATCHED ORIGINAL HEEL PAD ACCURATELY APPLIED USING THE SAME METHOD AS OEM.

**MEETS OR EXCEEDS OEM SPECIFICATIONS.

**DIMMER SWITCH GROMMET INCLUDED.

**COLOR SAMPLES ARE AVAILABLE FOR COLORS OTHER THAN BLACK.

**DYE LOTS WILL VARY +/- 10%. THIS IS COMMON IN THE CARPET INDUSTRY. CUSTOMERS ARE ENCOURAGED TO ORDER ALL CARPETED PRODUCTS AT THE SAME TIME TO ENSURE MATCHING DYE LOT.

**FOR YEARS AND MODELS NOT LISTED PLEASE CALL OUR SALES DEPARTMENT AT 800-363-8804

CARPET (NYLON LOOP)

The finest available today. Two-piece pre molded shape made with an original specification blend of 100% Nylon. All carpets include 36oz. jute padding on the back-side, dimmer switch grommet, color matched original style heel pad and vinyl bound edge where the front and rear sections overlap. Carpet kits are not shipped with pre-cut holes. This must be done during installation of carpet. Some other minor trimming may be needed. For years and models not listed please call our sales department for more information. We are able to get carpet kits for many other Oldsmobile models and years not shown.

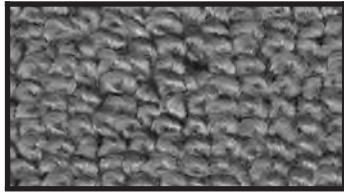

Loop Style

- 1964-67 Cutlass & 442**
CA64GUA(C) (2-door/Automatic).....\$195.00/ea.
CA64GUS(C) (2-door/Manual).....\$195.00/ea.
- 1968-72 Cutlass & 442 (shown)**
CA68GUA(C) (2-door/Automatic).....\$195.00/ea.
CA68GUS(C) (2dr. Manual w/o console) ..\$195.00/ea.
CA68GUSW(C) (2dr. Manual w/ console) ..\$195.00/ea.

CARPET YARDAGE

Need additional carpet?
 We offer carpet yardage in 1yd. and 2yd. cuts. Please specify color at time of order. We highly recommend purchasing extra yardage along with your carpet kit to ensure color match.



Loop Carpet

CAYD(C) (1 yard).....\$79.00/yd.
 For colors other than black please refer to color code list located at the top of this page.

SOUND DAMPENING

Kits are designed on current "state-of-the-art" auto acoustic technology, to insulate and control the noise, vibration and heat.

1964-65 A-Body Hardtop/Coupe Models

- SD64GA-H (Dampening Kit)**.....\$949.00/ea.
 Kit includes Body Panel, Cowl, Floor, Roof & Trunk pieces.
SD64GA-BPK (Body Panel).....\$189.00/ea.
SD64GA-CK (Cowl).....\$129.00/ea.
SD64GA-FK (Floor).....\$339.00/ea.
SD64GA-RK (Roof).....\$189.00/ea.
SD64GA-TK (Trunk).....\$189.00/ea.

1964-65 A-Body Convertible Models

- SD64GA-V (Dampening Kit)**.....\$829.00/ea.
 Kit includes Body Panel, Cowl, Floor & Trunk pieces.
SD64GA-VBPK (Body Panel).....\$189.00/ea.
SD64GA-VCK (Cowl).....\$129.00/ea.
SD64GA-VFK (Floor).....\$339.00/ea.
SD64GA-VTK (Trunk).....\$189.00/ea.

1966-67 A-Body Hardtop/Coupe Models

- SD66GA-H (Dampening Kit)**.....\$949.00/ea.
 Kit includes Body Panel, Cowl, Floor, Roof & Trunk pieces.
SD66GA-BPK (Body Panel).....\$189.00/ea.
SD66GA-CK (Cowl).....\$129.00/ea.
SD66GA-FK (Floor).....\$339.00/ea.
SD66GA-RK (Roof).....\$189.00/ea.
SD66GA-TK (Trunk).....\$189.00/ea.

1966-67 A-Body Convertible Models

- SD66GA-V (Dampening Kit)**.....\$829.00/ea.
 Kit includes Body Panel, Cowl, Floor & Trunk pieces.
SD66GA-VBPK (Body Panel).....\$189.00/ea.
SD66GA-VCK (Cowl).....\$129.00/ea.
SD66GA-VFK (Floor).....\$339.00/ea.
SD66GA-VTK (Trunk).....\$189.00/ea.

SOUND DAMPENING CONT.

1968-72 A-Body Hardtop/Coupe Models

- SD68GA-H (Dampening Kit)**.....\$999.00/ea.
 Kit includes Body Panel, Cowl, Floor, Roof & Trunk pieces.
SD68GA-BPK (Body Panel).....\$189.00/ea.
SD68GA-CK (Cowl).....\$129.00/ea.
SD68GA-FK (Floor).....\$339.00/ea.
SD68GA-RK (Roof).....\$189.00/ea.
SD68GA-TK (Trunk).....\$189.00/ea.

1968-72 A-Body Convertible Models

- SD68GA-V (Dampening Kit)**.....\$829.00/ea.
 Kit includes Body Panel, Cowl, Floor & Trunk pieces.
SD68GA-VBPK (Body Panel).....\$189.00/ea.
SD68GA-VCK (Cowl).....\$129.00/ea.
SD68GA-VFK (Floor).....\$339.00/ea.
SD68GA-VTK (Trunk).....\$189.00/ea.

SOUND DEADENER

This heavyweight material installs under the carpet directly against the floorpan to reduce heat and noise. Pre-cut to correct shape and size.

1964-67 Cutlass & 442

- SD64GA**.....\$99.00/ea.

1968-72 Cutlass & 442

- SD68GA**.....\$99.00/ea.

KICK PANEL INSULATION

Die-cut jute insulation pads fit between the plastic kick panel and the body sheet metal to protect from moisture.

1964-67 Cutlass & 442

- KI64GA**.....\$15.00/pr.

1968-72 Cutlass & 442

- KI68GA**.....\$15.00/pr.

KICK PANELS



Reproduction plastic kick panels made for models with factory air conditioning. These will also fit non-air conditioning models, but do not have the fresh-air outlet vents. Available in black only.

1964 Cutlass & 442

- KI64GA100**.....\$159.00/pr.

1965-66 Cutlass & 442

- KI65GA100**.....\$159.00/pr.

1967 Cutlass & 442

- KI67GA100 (shown)**.....\$159.00/pr.

1968-72 Cutlass & 442

- KI68GA100**.....\$149.00/pr.

KICK PANEL CARPET

Kick panel carpet kits made of nylon loop style carpeting and vinyl trim binding. Please specify with or without A/C, with or without fresh-air vent(s) and color of carpet and vinyl binding at time of order.



1964 Cutlass & 442 (all models)

- KI64GAW/O(C)**
 (with fresh air vents & no A/C).....\$65.00/pr.
KI64GAW/AF(C)
 (with driverside fresh air vent & A/C).....\$65.00/pr.

1964 Cutlass & 442 (all models)

- KI64GAW/A(C)**
 (with A/C & no fresh air vent).....\$65.00/pr.

1965-66 Cutlass & 442 (all models)

- KI65GAW/O(C)**
 (with fresh air vents & no A/C).....\$65.00/pr.
KI65GAW/AF(C)
 (with driverside fresh air vent & A/C).....\$65.00/pr.

1965-67 Cutlass & 442 (all models)

- KI65GAW/A(C)**
 (with A/C & no fresh air vent).....\$65.00/pr.

1967 Cutlass & 442 (all models)

- KI67GAW/O(C)**
 (with fresh air vents & no A/C).....\$65.00/pr.
KI67GAW/AF(C)
 (with driverside fresh air vent & A/C).....\$65.00/pr.

1968 Cutlass & 442 (all models)

- KI68GAW/O(C)** (w/o A/C).....\$65.00/pr.

1968-72 Cutlass & 442 (all models)

- KI68GAW/A(C)** (with A/C) (shown).....\$65.00/pr.

- 1969-72 Cutlass & 442 (Holiday Cpe. & Conv.)**
KI69GAW/O(C) (w/o A/C).....\$65.00/pr.

- 1969-72 Cutlass & 442 (Sports Coupe)**
KI69GASW/O(C) (w/o A/C).....\$65.00/pr.





Providing the automotive industry
with the world's highest quality
soft trim products and services
RIGHT HERE AT HOME

STILL ASSEMBLED AND
MADE IN THE ★★★★★
USA 

THERE REALLY IS A DIFFERENCE!!

Legendary
AUTO INTERIORS LTD.

www.legendaryautointeriors.com





LEGENDARY'S CUSTOM VINTAGE RUBBER STYLE FLOORMATS

DESIGNED TO FIT WHOLE FLOORPAN OF CAR LOGOS ON FRONT AND REAR MATS

How many times have you wished for automotive floormats that have custom-fit floopan shapes, that are easily cleanable and also have that "factory original" styling that would make you proud to display them in your classic car? Our "Custom Vintage" rubber style floormats will please the most discriminating buyer and provide years of carefree use.



www.legendaryautointeriors.com

CUSTOM DESIGN FLOORMATS

AVAILABLE IN ALL YEARS,
MAKES AND MODELS



Challenger
R/T

1 Color
insert

Adds \$25 to base price



Challenger
R/T

2 Color
insert

Adds \$50 to base price



Challenger
R/T

3 Color
insert

Adds \$75 to base price

DESIGN YOUR OWN
INSERTS & COLORS

www.legendaryautointeriors.com



FLOORMAT BASE & INSERT COLORS

BASE COLORS

001 Black - 007 Dark Blue - 011 Medium Blue - 018 Bright Red - 020 Red - 023 Tan - 031 Maroon
 033 Dark Gold - 037 Aqua - 050 Turquoise - 057 Dk Olive Green - 079 Gray
 098 Brown - 129 Dark Saddle - 132 Gold - 148 Silver Grey

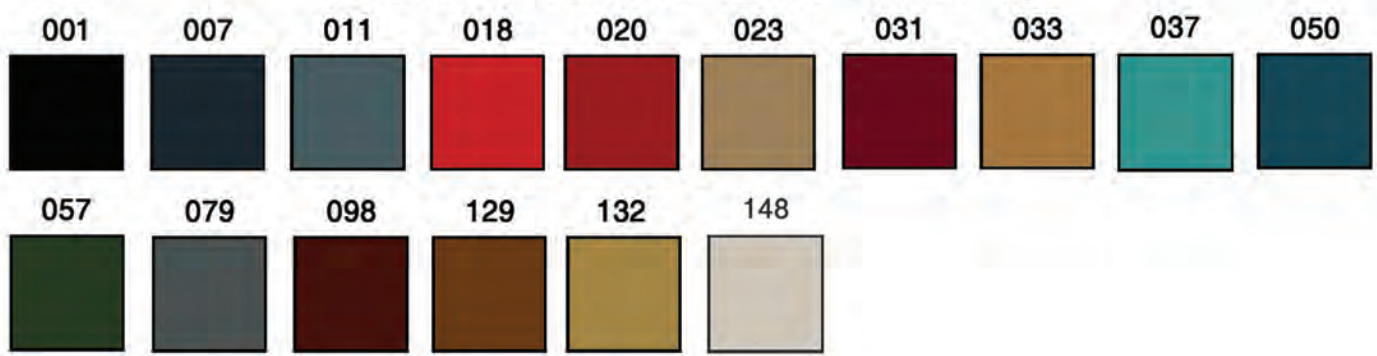

INSERT COLORS

133 Cream - 134 Sandalwood - 137 Aztec Gold - 138 Buckskin - 139 Sienna - 141 Coffee Bean - 142 Football - 143 Basketball
 150 Lemon Twist - 151 Mellow Yellow - 153 Precious Purple - 154 Plum Crazy - 155 Moody Blue - 156 Sky Blue
 157 Light Blue - 159 Pacific Blue - 160 Caribbean Blue - 161 Royal Blue - 163 Navy Blue - 164 Groovy Blue
 165 Sassy Grass - 166 Pine - 167 Mint Green - 168 Hunter Green - 169 Antique Green - 170 Aqua Marine - 171 Mango
 172 Awesome Orange - 173 Sunset Orange - 174 Panther Pink - 175 Radical Red - 176 Cherry Red - 177 Cranberry
 178 Razzberry - 179 Garnet - 180 Smoke - 181 Platinum - 182 Medium Grey - 183 Silver - 184 Charcoal



***Note - To order mats with colored inserts please call our sales department**

Actual colors will vary from samples on this page. Contact our Sample Request Department for actual color samples at 1-800-363-8804 or send us an email through our Sample Request Center on our website at www.legendaryautointeriors.com



1964-72 OLDSMOBILE CUTLASS & 442

Cutlass
W-31

Cutlass
W-31

SURE-GRIP™
CURVIC ANTI-SKID BACKING



1964-67 Cutlass - Script letters w/ Cutlass emblem
FMCT0001003(C)

1964-67 442 - 442 logo
FMCT0001004(C)

1964-67 Cutlass Supreme - Script letters w/ CS emblem
FMCT0001005(C)

1968-69 Cutlass Supreme - Script letters w/ CS emblem
FMCT0002001(C)

1968 442 - 442 logo
FMCT0002003(C)

1968 442 W-30 - 442 W-30 logo
FMCT0002004(C)

1968-69 Cutlass S - Script letters w/ S emblem
FMCT0002006(C)

1969 Cutlass W-31 - Script letters w/ W-31
FMCT0002007(C)

1969-72 442 - 442 logo
FMCT0002008(C)

1969-72 442 W-30 - 442 W-30 logo
FMCT0002009(C)

1970 Cutlass S - Script letters w/ S emblem
FMCT0002010(C)

1970 Cutlass Supreme - Script letters w/ CS emblem
FMCT0002011(C)

1970 Cutlass SX - Script letters w/ SX logo
FMCT0002012(C)

1970 Cutlass W-31 - Script letters w/ W-31
FMCT0002013(C)

1971 Cutlass SX - Script letters w/ SX logo
FMCT0002014(C)

1971-72 Cutlass - Script letters w/ Cutlass emblem
FMCT0002015(C)

1971-72 Cutlass S - Script letters w/ S emblem
FMCT0002016(C)

1971-72 Cutlass Supreme - Script letters w/ CS emblem
FMCT0002017(C)

FLOORMAT PRICING:
ALL COLORS - \$189.00/set

1964-67 Cutlass



1964-67 442



1964-69
Cutlass Supreme

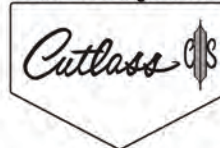

1968 442



1968 442 W-30



1968-69 Cutlass S



1969 Cutlass W-31



1969-72 442

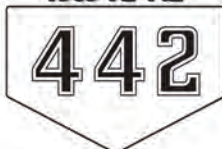

1969-72 442 W-30



1970 Cutlass S



1970 Cutlass Supreme



1970 Cutlass SX



1970 Cutlass W-31



1971 Cutlass SX



1971-72 Cutlass



1971-72 Cutlass S



1971-72
Cutlass Supreme

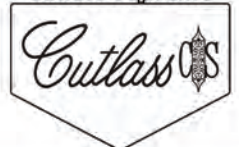

FLEX TREAD®

YOU ASK FOR IT...WE DELIVERED!!



PINK COMING
2023!



YOU ASK FOR IT...WE DELIVERED!!

PATENTED

SCENERY MATS

VERSAFIT™ TRIM-TO-FIT MATS

**MANY KOOL SCENES AVAILABLE
AND MORE COMING SOON!**



FISHING SCENE

BOOTMATS



DUCK SCENE

SCENERY AVAILABLE ON VERSAFIT™ & BOOTMATS



WHITETAIL SCENE



EQUINE SCENE



**SCORCHED EARTH &
TIRE TRACK SCENE**

Versafit™

Trim-To-Fit Mats

CHOOSE
YOUR
SCENE

VERSAFIT™ universal trim-to-fit floormats fit most domestic and foreign vehicles. Mats can be cut to fit your vehicle's unique floorpan. Includes manual screw in style safety retention positioning posts for installation.



Bootmats

CHOOSE
YOUR
SCENE

"Fun"ctional Boot Mats from FLEXTREAD bring a KOOL look inside while leaving the mess at the door. Featuring scenery and measuring finished size 16" tall by 28" wide.



FLOORMAT & BOOTMAT COLORS



001 - Black



007 - Dark Blue



011 - Medium Blue



018 - Bright Red



020 - Red



023 - Tan



031 - Maroon



050 - Turquoise

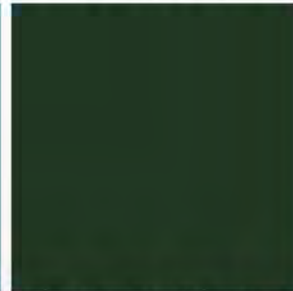

057 - Dark Olive Green



074 - Pink



079 - Grey

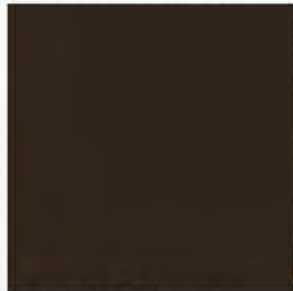

098 - Brown



129 - Dark Saddle



132 - Gold

CAMOUFLAGE

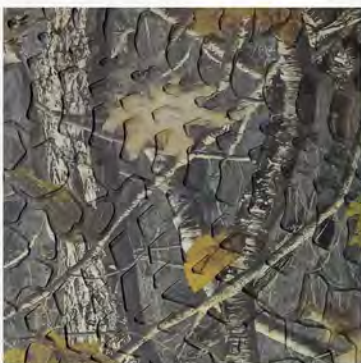

200 - Rugged Woods



202 - Cyberflage



201 - Rugged Woods "Pink"



203 - Cyberflage "Pink"

FLEXTREAD LLC
1-833-700-3539 EXT. 222
WWW.FLEXTREADMATS.COM





Providing the automotive industry
with the world's highest quality
soft trim products and services
RIGHT HERE AT HOME

**STILL ASSEMBLED AND
MADE IN THE** ★★★★★
USA 

THERE REALLY IS A DIFFERENCE!!



Legendary
AUTO INTERIORS LTD.®



www.legendaryautointeriors.com





DASHES, CONSOLES AND ACCESORIES

 facebook.com/legendaryautointeriors
 twitter.com/legendaryautoin

 www.legendaryautointeriors.com
 instagram.com/legendaryautointeriorsltd
 youtube.com/user/legendaryauto

Oldsmobile

1968-72 WOODGRAIN DASH INSERTS

Make your dash look new again with these authentically reproduced woodgrain dash inserts for 1968-72 models.

1968 Hurst Olds
WC68GU-HOCPE \$219.00/ea.

1969 Cutlass, 442 (all models)
WC69GU-CPECNV \$220.00/ea.

1970 Cutlass & 442 (all coupe models)
WC70GU-CPE \$179.00/ea.
WC70GU-CRS (with cruise control) .. \$179.00/ea.
WC70GU-RD (radio delete)..... \$179.00/ea.
☞ Burlwood woodgrain

1970 Cutlass & 442 (convertible models)
WC70GU-CONV \$179.00/ea.
WC70GU-CNVCRS (w/ cruise control) ... \$179.00/ea.
☞ Burlwood woodgrain

1971 Cutlass & 442 (all coupe models)
WC71GU-CPE \$179.00/ea.
WC71GU-CRS (with cruise control) .. \$179.00/ea.
WC71GU-RD (radio delete)..... \$179.00/ea.
☞ Walnut woodgrain

1971 Cutlass & 442 (convertible models)
WC71GU-CONV \$179.00/ea.
WC71GU-CNVCRS (w/ cruise control) ... \$179.00/ea.
☞ Walnut woodgrain

1972 Cutlass & 442 (all coupe models)
WC72GU-CPE \$179.00/ea.
WC72GU-CRS (with cruise control) .. \$179.00/ea.
WC72GU-RD (radio delete)..... \$179.00/ea.
☞ Rosewood woodgrain

1972 Cutlass & 442 (convertible models)
WC72GU-CONV \$179.00/ea.
WC72GU-CNVCRS (w/ cruise control) ... \$179.00/ea.
☞ Rosewood woodgrain

1970-72 '8-TRACK' WOODGRAIN FACEPLATE

Correctly reproduced insert of the factory woodgrain faceplate for 1970-72 models with optional 8-track player.



1969-70 Cutlass & 442
WC70GU-8TRACK (shown)..... \$89.00/ea.
☞ Burlwood woodgrain

1971 Cutlass & 442
WC71GU-8TRACK \$89.00/ea.
☞ Walnut woodgrain

1972 Cutlass & 442
WC72GU-8TRACK \$89.00/ea.
☞ Rosewood woodgrain

ALUMINUM CONSOLE INSERTS

Die-cut aluminum console inserts for 1967-68 models with console and automatic transmission.

1967-68 Cutlass & 442
WC67GU \$79.00/ea.

WOODGRAIN CONSOLE INSERTS

Woodgrain console inserts are machine-stamped and feature an adhesive-backed design.

1968 Hurst Olds
WC68GU-HO \$89.00/ea.

1969 Hurst Olds
WC69GU-HO \$89.00/ea.

1969 Cutlass & 442
WC69GU (with A/T) \$89.00/ea.

1970 Cutlass & 442
WC70GU (with A/T) \$89.00/ea.
WC70GU-DG (w/ Dual Gate shifter).... \$89.00/ea.
WC70GU-4SP (4-speed)..... \$89.00/ea.

1971 Cutlass & 442
WC71GU (with A/T) \$89.00/ea.
WC71GU-DG (w/ Dual Gate shifter).... \$89.00/ea.
WC71GU-4SP (4-speed)..... \$89.00/ea.

1972 Cutlass & 442
WC72GU (with A/T) \$89.00/ea.
WC72GU-DG (w/ Dual Gate shifter).... \$89.00/ea.
WC72GU-4SP (4-speed)..... \$89.00/ea.

GLOVEBOX LINERS

Glovebox liners are die-cut and pre-stapled with all mounting hardware attached for easy installation.



1964-67 Cutlass & 442
GB64GU \$39.00/ea.

1968-69 Cutlass & 442
GB68GUW/O (w/o A/C)..... \$29.00/ea.
GB68GUW/A (with A/C)..... \$39.00/ea.

1970-72 Cutlass & 442
GB70GU \$39.00/ea.

GLOVEBOX EMBLEMS

Replace faded or broken original glovebox emblems on your 1968-72 442 with these new reproductions.



1968-69 442
GB68GU-EMBLEM \$29.00/ea.

1970-71 442
GB70GU-EMBLEM (shown) \$39.00/ea.
☞ Although not correct, this emblem will work on 1972 models.

DASH PAD EMBLEMS

As-Original dash pad emblems

HURST EQUIPPED INTERIOR EMBLEM
DP64GA-HURST \$29.00/ea

UNDERDASH INSULATION

Die-cut to original specifications, this insulation eliminates underdash noise and vibration.

1964-67 Cutlass & 442
UD64GA \$15.00/kit

1968-72 Cutlass & 442
UD68GA \$39.00/kit



FIREWALL INSULATION



Die-cut jute insulation pad comes complete with a stamped rubber backing on one side like the originals. This insulation fastens to and runs the entire length of the firewall to help reduce engine heat and noise. Insulation clips included.

1964-67 Cutlass & 442

FI64GA (w/o air conditioning)..... \$59.00/ea.
FI64GA-W/A (with air conditioning)... \$59.00/ea.

1968-72 Cutlass & 442

FI68GA-W/O (w/o air conditioning) ... \$59.00/ea.
FI68GA-W/A (with air conditioning)... \$59.00/ea.

OEM FIREWALL INSULATION

Firewalls are cut and punched with standard factory holes and are shipped ready-to-install with the appropriate "period" insulation attached.

1964-67 Cutlass & 442

FI64GAO (w/o air conditioning)..... \$289.00/ea.
FI64GAO-W/A (with air conditioning) \$289.00/ea.

1968-72 Cutlass & 442

FI68GAO (w/o air conditioning)..... \$289.00/ea.
FI68GAO-W/A (with air conditioning) \$289.00/ea.

FIREWALL GUARD FASTENER

These fasteners will help keep your carpet guard and carpet in their proper positions.

1967-69 Camaro

FI-FASTENER (set of 4)..... \$15.00/set



GAS PEDAL ROD PIN



Dimensionally accurate to the original with the same fit and function.

1968-72 Cutlass & 442 NEW!!!

PB68GA-RODPIN \$7.00/ea.

GAS PEDAL SPRING



Correct tension spring for all 68-72 A-Body applications.

1968-72 Cutlass & 442 NEW!!!

PB68GA-SPRING \$7.00/ea.

PEDAL PADS & BEZELS

Reproduction pedal pads and bezels for accelerators, brake/clutch and parking brake.

ACCELERATORS & BEZELS

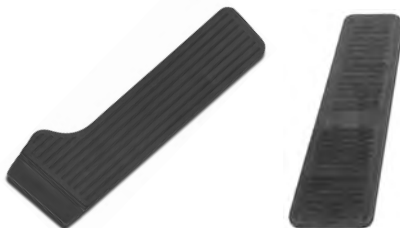

1964-67 Cutlass & 442

PB64GA-A (pad) (shown left) \$29.00/ea.
 ☞ This pad is the closest available to the original.

1968-72 Cutlass & 442

PB68GU-A (pad) (shown right) \$19.00/ea.

PEDAL PADS & BEZELS CONT.

4-SPEED CLUTCH/BRAKE PADS & BEZELS



1964-72 Cutlass & 442

PB64GA4SP-B/C (pad)..... \$5.00/ea.
PB64GA4SP-B/CBEZ (bezel)..... \$10.00/pr.

1967-72 Cutlass & 442 (with Disc Brakes)

PB67GA4SP-B/C (pad)..... \$15.00/ea.
 ☞ Brake only. For clutch pad use part #PB64GA4SP-B/C.

AUTOMATIC BRAKE PADS & BEZELS



1964-72 Cutlass & 442

PB64GA-B (pad)..... \$15.00/ea.
PB64GG-BBEZ (bezel)..... \$17.00/ea.



1967-72 Cutlass & 442 (with Disc Brakes)

PB67GA-B (pad)..... \$15.00/ea.

PARKING BRAKE PADS



1964-72 Cutlass & 442

PB64GA-P (pad)..... \$5.00/ea.
PB64GA-PBEZ (bezel) \$5.00/ea.

STEERING COLUMN SEAL

Precision die-cut gasket seals the steering column at the firewall.



1964-67 Cutlass & 442
GK64GA (shown right).....\$15.00/ea.

1968-72 Cutlass & 442
GK68GA (shown left).....\$15.00/ea.

FIREWALL STEERING COLUMN COVER

Made of ABS plastic, this cover mounts where the steering column meets the firewall holding the carpet in place around the base of the steering column. Mounting hardware included.



1964-66 Cutlass & 442
TA64GA-COVER (shown bottom).....\$59.00/ea.



1967 Cutlass & 442
TA67GA-COVER (shown bottom).....\$59.00/ea.



1968-72 Cutlass & 442
TA68GA-COVER (shown top).....\$49.00/ea.

SHIFTER BOOTS



This reproduction shifter boot fits 1964-69 models with standard transmission and a console. Fits on top of the console.

1964-69 Cutlass & 442
TN64GU-U.....\$59.00/ea.



Reproduction shifter boots for 1964-69 models with a console and standard transmission. These boots fit under the console on the floorboard.

1964-65 Cutlass & 442
TN64GU-L (Round shifter) (shown)\$19.00/ea.



Shifter boots made for 1970-72 models with a console and standard transmission. Upper boot fits on top of the console and is molded to accept the shift ornament while the lower boot fits under the console on the floor board.

1970-72 Cutlass & 442
TN70GU-U (Upper) (shown left).....\$69.00/ea.
TN70GU-L (Lower) (shown right).....\$79.00/ea.
Ⓢ Lower boot also fits non-console 4-speed models.

SHIFTER BOOT ORNAMENT





Chrome ornament fits in the molded section of the upper shift boot on 1970-72 models with standard transmission and a console. Use with part #TN70GU-U.



1970-72 Cutlass & 442
TN70GU-ORNAMENT\$29.00/ea.





HEADLINERS AND TRIM ACCESORIES

 facebook.com/legendaryautointeriors
 twitter.com/legendaryautoin

 www.legendaryautointeriors.com
 instagram.com/legendaryautointeriorsltd
 youtube.com/user/legendaryauto

Headliner Grains and Colors

Legendary Auto Interiors headliners are manufactured to original specifications and are available in a variety of colors in Perforated or Non-Perforated pattern. Each headliner is assembled with heavy-duty stitching.

If your year/model is not listed please contact our sales department for assistance on availability. Please specify perforated or non-perforated at time of order. Sample approval is highly recommended for colors other than black.

STANDARD *style*

Basketweave (1964-69)

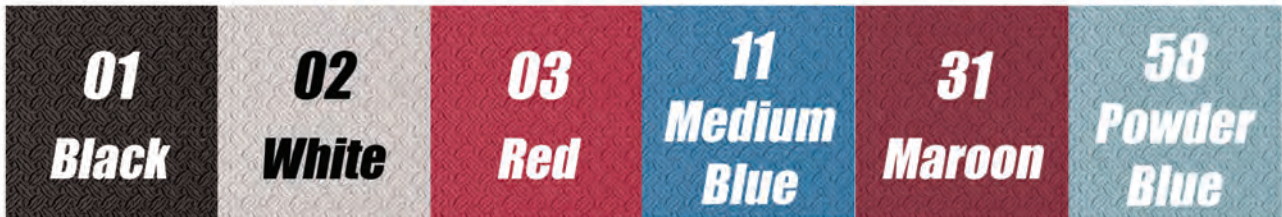

Non-Perforated (1970-72)



HEADLINERS

1964 F-85, Cutlass & 442 (Sports Coupe)
(Basketweave Grain)
 HL64GU01B1 (black).....\$169.00/ea.
 HL64GU02B1 (white).....\$169.00/ea.
 HL64GU58B1 (powder blue).....\$169.00/ea.

1964 F-85, Cutlass & 442 (Holiday Coupe)
(Basketweave Grain)
 HL64GU01B2 (black).....\$169.00/ea.
 HL64GU02B2 (white).....\$169.00/ea.
 HL64GU58B2 (powder blue).....\$169.00/ea.

1965 F-85, Cutlass & 442
(Sports Coupe & Holiday Coupe)
(Basketweave Grain)
 HL65GU01B (black).....\$169.00/ea.
 HL65GU02B (white).....\$169.00/ea.
 HL65GU58B (powder blue).....\$169.00/ea.

1966 F-85, Cutlass & 442 (Early production)
(Sports Coupe & Holiday Coupe)
(Basketweave Grain)
 HL66GU01B1 (black).....\$169.00/ea.
 HL66GU02B1 (white).....\$169.00/ea.
 HL66GU58B1 (powder blue).....\$169.00/ea.
 ☞ On early 1966 models the rear of the headliner continues to the package tray area and has a small sail panel. See diagram shown below.

1966 F-85, Cutlass & 442 (Late production)
(Sports Coupe & Holiday Coupe)
(Basketweave Grain)
 HL66GU01B2 (black).....\$169.00/ea.
 HL66GU02B2 (white).....\$169.00/ea.
 HL66GU58B2 (powder blue).....\$169.00/ea.
 ☞ Late 1966 models have a full sail panel board. See diagram shown below.

1967 F-85, Cutlass & 442 (Sports Coupe)
(Basketweave Grain)
 HL67GU01B1 (black).....\$169.00/ea.
 HL67GU02B1 (white).....\$169.00/ea.
 HL67GU03B1 (red).....\$169.00/ea.
 HL67GU11B1 (medium blue).....\$169.00/ea.

1967 F-85, Cutlass & 442 (Holiday Coupe)
(Basketweave Grain)
 HL67GU01B2 (black).....\$169.00/ea.
 HL67GU02B2 (white).....\$169.00/ea.
 HL67GU03B2 (red).....\$169.00/ea.
 HL67GU11B2 (medium blue).....\$169.00/ea.

1968 F-85 Cutlass & 442 (Sports Coupe)
(Basketweave Grain)
 HL68GU501B1 (black) (5-bow).....\$169.00/ea.
 HL68GU502B1 (white) (5-bow).....\$169.00/ea.
 HL68GU511B1 (med blue) (5-bow).....\$169.00/ea.
 HL68GU531B1 (maroon) (5-bow).....\$169.00/ea.
 HL68GU601B1 (black) (6-bow).....\$169.00/ea.
 HL68GU602B1 (white) (6-bow).....\$169.00/ea.
 HL68GU611B1 (med blue) (6-bow).....\$169.00/ea.
 HL68GU631B1 (maroon) (6-bow).....\$169.00/ea.

1968 Cutlass, Supreme & 442 (Holiday Coupe)
(Basketweave Grain)
 HL68GU501B2 (black) (5-bow).....\$169.00/ea.
 HL68GU502B2 (white) (5-bow).....\$169.00/ea.
 HL68GU511B2 (med blue) (5-bow).....\$169.00/ea.
 HL68GU531B2 (maroon) (5-bow).....\$169.00/ea.
 HL68GU601B2 (black) (6-bow).....\$169.00/ea.
 HL68GU602B2 (white) (6-bow).....\$169.00/ea.
 HL68GU611B2 (med blue) (6-bow).....\$169.00/ea.
 HL68GU631B2 (maroon) (6-bow).....\$169.00/ea.

1969 F-85, Cutlass & 442 (Sports Coupe)
(Basketweave Grain)
 HL69GU01B1 (black).....\$169.00/ea.
 HL69GU02B1 (white).....\$169.00/ea.
 HL69GU03B1 (red).....\$169.00/ea.
 HL69GU11B1 (medium blue).....\$169.00/ea.
 HL69GU132B1 (gold).....\$169.00/ea.

1969 Cutlass, Supreme & 442 (Holiday Coupe)
(Basketweave Grain)
 HL69GU01B2 (black).....\$169.00/ea.
 HL69GU02B2 (white).....\$169.00/ea.
 HL69GU03B2 (red).....\$169.00/ea.
 HL69GU11B2 (medium blue).....\$169.00/ea.
 HL69GU132B2 (gold).....\$169.00/ea.

1970-72 F-85, Cutlass & 442 (Sports Coupe)
(Non-Perforated Grain)
 HL70GU01NP1 (black).....\$169.00/ea.
 HL70GU02NP1 (white).....\$169.00/ea.
 HL70GU07NP1 (dark blue).....\$169.00/ea.
 HL70GU11NP1 (medium blue).....\$169.00/ea.
 HL70GU13NP1 (dark green).....\$169.00/ea.
 HL70GU38NP1 (sandalwood).....\$169.00/ea.
 HL70GU98NP1 (brown).....\$169.00/ea.

1970 Cutlass & 442 (Holiday Coupe)
1971-72 Cutlass & 442 (Hardtop Coupe)
(Non-Perforated Grain)
 HL70GU01NP2 (black).....\$169.00/ea.
 HL70GU02NP2 (white).....\$169.00/ea.
 HL70GU07NP2 (dark blue).....\$169.00/ea.
 HL70GU11NP2 (medium blue).....\$169.00/ea.
 HL70GU13NP2 (dark green).....\$169.00/ea.
 HL70GU38NP2 (sandalwood).....\$169.00/ea.
 HL70GU98NP2 (brown).....\$169.00/ea.

1970 Cutlass Supreme (Holiday Coupe)
1971-72 Cutlass Supreme (Hardtop Coupe)
(Non-Perforated Grain)
 HL70GU01NP3 (black).....\$169.00/ea.
 HL70GU02NP3 (white).....\$169.00/ea.
 HL70GU07NP3 (dark blue).....\$169.00/ea.
 HL70GU11NP3 (medium blue).....\$169.00/ea.
 HL70GU13NP3 (dark green).....\$169.00/ea.
 HL70GU38NP3 (sandalwood).....\$169.00/ea.
 HL70GU98NP3 (brown).....\$169.00/ea.

UPPER WINDSHIELD TRIM

Interior upper windshield trim strip mounts at the top of the windshield and helps hold the headliner in place. Available in black only, paint as required.

1964-67 Cutlass & 442
 WT64GA.....\$27.00/ea.

NOS HEADLINERS

Some colors and grains are not reproduced in today's market. We offer NOS (New Old Stock) headliners for those extremely limited items. Many years and models are available. Please call for assistance.

HLNOS.....\$935.00/ea.
 ☞ Please specify year and model.

HEADLINER INSULATION

Headliner insulation kits glue directly to the roof and provide protection from noise, heat and cold infiltration.



1964-67 Cutlass & 442
 HI64GA (4pc.).....\$29.00/ea.

1968-72 Cutlass & 442
 HI68GA (4pc.).....\$29.00/ea.

HEADLINER BOW RETAINER CLIPS

Plastic retainer clips slide onto the edge of the inner roof-rail and help secure the headliner bows during installation of headliner.



1964-72 Cutlass & 442
 HLGA-CLIPS4 (Pkg/4).....\$19.00/pk.

1968-72 Cutlass & 442
 HLGA-CLIPS6 (Pkg/6).....\$29.00/pk.

REAR WINDOW TRIM

Interior rear window trim made of molded plastic features all the correct contours as the originals. This trim snaps into place around the rear window holding the headliner and sail panel boards in place along with providing a finished look. Available in black only, paint as required.

1964-65 Cutlass & 442 (Hardtop)
 RT64GU07 (Complete 7 pc. set).....\$129.00/set
 RT64GU03 (Upper & side pcs. only).....\$99.00/set
 RT64GU-UPPER (Upper corners only).....\$29.00/pr.
 RT64GU-LOWER (Lower corners only).....\$49.00/pr.

1966-67 Cutlass & 442 (Hardtop)
 RT66GA03 (Complete 3 pc. set).....\$99.00/set
 RT66GA-CTRCAP (Center cap only).....\$49.00/ea.

SAIL PANEL BOARDS

Die-cut to original size and shape, these reproduction sail panel boards replace warped or water damaged originals. These panels are located between the package tray and headliner and come pre-covered with headliner material. Please specify pattern along with color at time of order.
 NOTE: Due to a special proprietary process used in-house, we guarantee the vinyl WILL NOT bubble or delaminate from the board.



1964-65 F-85, Cutlass & 442

1964-65 F-85 Cutlass & 442 (Basketweave Grain)

- SB64GU01B (black).....\$66.00/pr.
- SB64GU02B (white).....\$66.00/pr.
- SB64GU58B (powder blue).....\$66.00/pr.

1967 F-85, Cutlass & 442 (Basketweave Grain)

- SB66GU01B2 (black).....\$66.00/pr.
- SB66GU02B2 (white).....\$66.00/pr.
- SB66GU03B2 (red).....\$66.00/pr.
- SB66GU11B2 (medium blue).....\$66.00/pr.
- SB66GU58B2 (powder blue).....\$66.00/pr.

1968-69 F-85, Cutlass & 442 (Basketweave Grain)

- SB68GU01B (black).....\$66.00/pr.
- SB68GU02B (white).....\$66.00/pr.
- SB68GU03B (red).....\$66.00/pr.
- SB68GU11B (medium blue).....\$66.00/pr.
- SB68GU31B (maroon).....\$66.00/pr.
- SB68GU132B (gold).....\$66.00/pr.

1970-72 F-85, Cutlass & 442 (Non-Perforated Grain)

- SB70GU01NP1 (black).....\$66.00/pr.
- SB70GU02NP1 (white).....\$66.00/pr.
- SB70GU07NP1 (dark blue).....\$66.00/pr.
- SB70GU11NP1 (medium blue).....\$66.00/pr.
- SB70GU13NP1 (dark green).....\$66.00/pr.
- SB70GU38NP1 (sandalwood).....\$66.00/pr.
- SB70GU98NP1 (brown).....\$66.00/pr.

1970-72 Cutlass Supreme (Non-Perforated Grain)

- SB70GU01NP2 (black).....\$66.00/pr.
- SB70GU02NP2 (white).....\$66.00/pr.
- SB70GU07NP2 (dark blue).....\$66.00/pr.
- SB70GU11NP2 (medium blue).....\$66.00/pr.
- SB70GU13NP2 (dark green).....\$66.00/pr.
- SB70GU38NP2 (sandalwood).....\$66.00/pr.
- SB70GU98NP2 (brown).....\$66.00/pr.

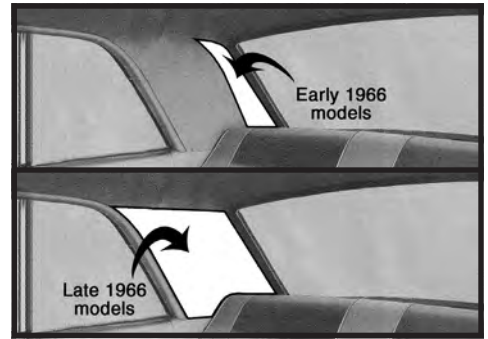

1966 F-85, Cutlass & 442 (Early production) (Basketweave Grain)

- SB66GU01B1 (black).....\$55.00/pr.
 - SB66GU02B1 (white).....\$55.00/pr.
 - SB66GU58B1 (powder blue).....\$55.00/pr.
- ☞ Early 1966 models have a small sail panel.

1966 F-85, Cutlass & 442 (Late production) (Basketweave Grain)

- SB66GU01B2 (black).....\$66.00/pr.
 - SB66GU02B2 (white).....\$66.00/pr.
 - SB66GU58B2 (powder blue).....\$66.00/pr.
- ☞ Late 1966 models have a full sail panel board.

DOMELIGHT LENS & BEZELS

Replacement dome light lenses and bezels for 1964-72 models.



1964-67 Cutlass & 442

- LL64GA (Lens only).....\$10.00/ea.



1968 Cutlass & 442

- LL68GA (Lens only).....\$15.00/ea.



1969-72 Cutlass & 442

- LL69GA (Lens only).....\$10.00/ea.



1964-67 Cutlass & 442

- LL64GA-BEZ (Bezel only).....\$29.00/ea.



1968 Cutlass & 442

- LL68GA-BEZ (Bezel only).....\$29.00/ea.



1969-72 Cutlass & 442

- LL69GA-BEZ (Bezel only).....\$15.00/ea.

COURTESY LIGHT LENSES & BEZELS

These replacement lenses and bezels mount to the interior sail panel boards located between the headliner and package tray.



1964-67 Cutlass & 442

- LL64GA-CRTSY (Lens) (shown).....\$10.00/ea.
- LL64GA-CRTSYBEZ (Bezel) (shown).....\$49.00/ea.

PILLAR POST MOLDINGS

These urethane-molded, not foam filled pillar moldings feature authentic grain and texture as the originals. Available in Black only, but can be painted to match interior colors.



1968-69 Cutlass & 442

- PP68GA-CPE01 (Black) (Coupe).....\$129.00/pr.

1968-72 Cutlass & 442

- PP68GA-CONV01 (Black) (Conv.).....\$129.00/pr.

SAIL PANEL WITH COURTESY LIGHT

1964-65 Cutlass & 442

- SB64GK(C)R-CRTSY.....\$52.00/ea.



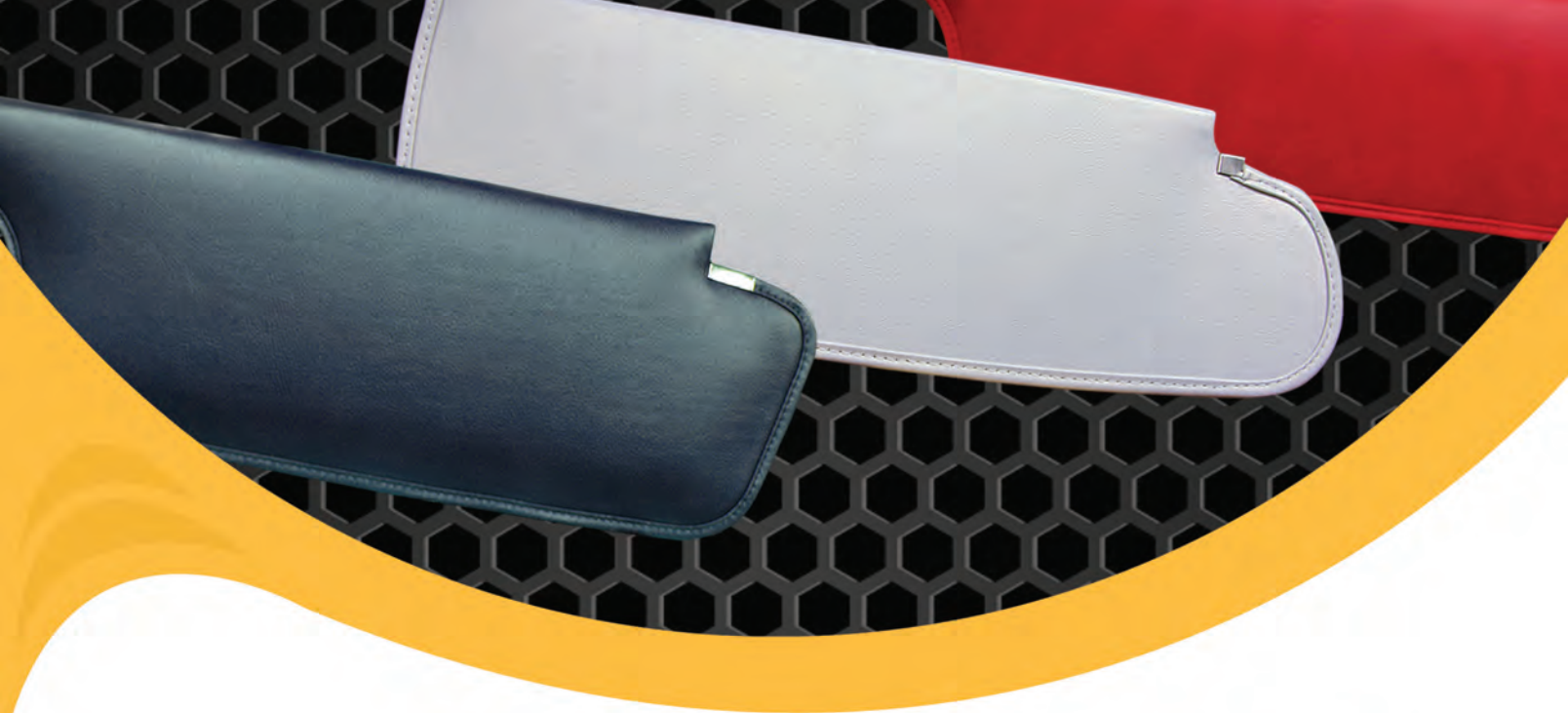

SUNVISORS

Original reproduction sunvisors are made with the correct grains and vinyl colors as applicable by year/make/model to compliment and match your Legendary interior. Superior materials and technology with World Class craftsmanship create the highest quality sunvisors available. Original mounting hardware and metal rod must be reused. Please specify hardtop or convertible and color at time of order.

- Factory correct size, shape, colors and grains by year, make and model
- Original fit and appearance
- Custom colors and grains available
- Limited Lifetime Warranty (*First and only in the industry!!!*)
- Correct multi layer construction applicable by year, make and model
- Available with or without cut-outs for driver and passenger mirror options



Correct multi layer construction & shape applicable by year, make, model & body style

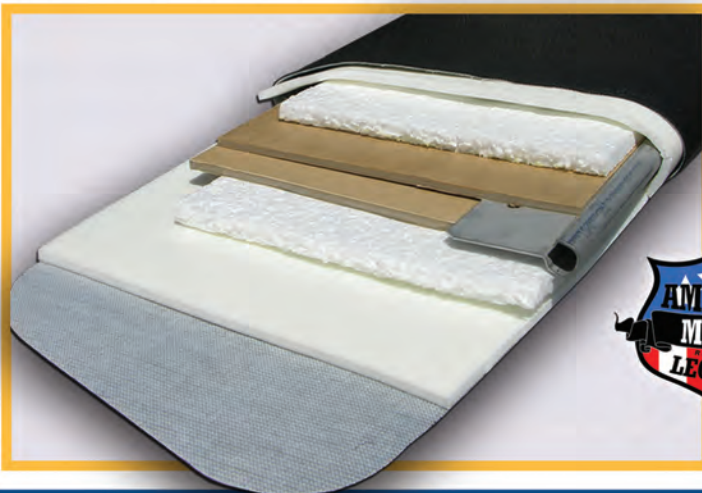

HARDTOP & SPORTS COUPE SUNVISORS

**1964-65 F-85, Cutlass & 442 (Sports Coupe)
(Basketweave Grain)**

SV64GU01B1-PA (black)	\$168.00/pr.
SV64GU02B1-PA (white)	\$168.00/pr.
SV64GU58B1-PA (powder blue)	\$168.00/pr.

**1964-65 Cutlass & 442 (Holiday Coupe)
(Basketweave Grain)**

SV64GU02B2-PA (white)	\$168.00/pr.
SV64GU58B2-PA (powder blue)	\$168.00/pr.

**1966-67 F-85, Cutlass & 442 (Sports Coupe)
(Basketweave Grain)**

SV66GU01B1-PA (black)	\$168.00/pr.
SV66GU02B1-PA (white)	\$168.00/pr.
SV66GU03B1-PA (red)	\$168.00/pr.
SV66GU11B1-PA (medium blue)	\$168.00/pr.
SV66GU58B1-PA (powder)	\$168.00/pr.

**1966-67 Cutlass & 442 (Holiday Coupe)
(Basketweave Grain)**

SV66GU01B2-PA (black)	\$168.00/pr.
SV66GU02B2-PA (white)	\$168.00/pr.
SV66GU03B2-PA (red)	\$168.00/pr.
SV66GU11B2-PA (medium blue)	\$168.00/pr.
SV66GU58B2-PA (powder)	\$168.00/pr.

**1968 F-85, Cutlass & 442 (Sports Coupe)
(Basketweave Grain)**

SV68GU01B1-PA (black)	\$168.00/pr.
SV68GU02B1-PA (white)	\$168.00/pr.
SV68GU11B1-PA (medium blue)	\$168.00/pr.
SV68GU31B1-PA (maroon)	\$168.00/pr.

**1968 Cutlass & 442 (Holiday Coupe)
(Basketweave Grain)**

SV68GU01B2-PA (black)	\$168.00/pr.
SV68GU02B2-PA (white)	\$168.00/pr.
SV68GU11B2-PA (medium blue)	\$168.00/pr.
SV68GU31B2-PA (maroon)	\$168.00/pr.

**1969 F-85, Cutlass & 442 (Sports Coupe)
(Basketweave Grain)**

SV69GU01B1-PA (black)	\$168.00/pr.
SV69GU02B1-PA (white)	\$168.00/pr.
SV69GU03B1-PA (red)	\$168.00/pr.
SV69GU11B1-PA (medium blue)	\$168.00/pr.
SV69GU132B1-PA (gold)	\$168.00/pr.

**1969 Cutlass & 442 (Holiday Coupe)
(Basketweave Grain)**

SV69GU01B2-PA (black)	\$168.00/pr.
SV69GU02B2-PA (white)	\$168.00/pr.
SV69GU03B2-PA (red)	\$168.00/pr.
SV69GU11B2-PA (medium blue)	\$168.00/pr.
SV69GU132B2-PA (gold)	\$168.00/pr.

**1970 F-85, Cutlass & 442 (Sports Coupe)
(Non-Perforated Grain)**

SV70GU01NP1-PA (black)	\$168.00/pr.
SV70GU02NP1-PA (white)	\$168.00/pr.
SV70GU11NP1-PA (medium blue)	\$168.00/pr.
SV70GU13NP1-PA (dark green)	\$168.00/pr.
SV70GU38NP1-PA (sandalwood)	\$168.00/pr.
SV70GU98NP1-PA (brown)	\$168.00/pr.

**1970 Cutlass & 442 (Holiday Coupe)
(Non-Perforated Grain)**

SV70GU01NP2-PA (black)	\$168.00/pr.
SV70GU02NP2-PA (white)	\$168.00/pr.
SV70GU11NP2-PA (medium blue)	\$168.00/pr.
SV70GU13NP2-PA (dark green)	\$168.00/pr.
SV70GU38NP2-PA (sandalwood)	\$168.00/pr.
SV70GU98NP2-PA (brown)	\$168.00/pr.

**1971-72 F-85, Cutlass & 442 (Hardtop Coupe & Sports Coupe)
(Non-Perforated Grain)**

SV71GU01NP1-PA (black)	\$168.00/pr.
SV71GU02NP1-PA (white)	\$168.00/pr.
SV71GU07NP1-PA (dark blue)	\$168.00/pr.
SV71GU13NP1-PA (dark green)	\$168.00/pr.
SV71GU98NP1-PA (brown)	\$168.00/pr.

CONVERTIBLE SUNVISORS

1964 Cutlass & 442 (Seville Grain)

SV64GA100G-PA (black)	\$168.00/pr.
SV64GA206G-PA (white)	\$168.00/pr.
SV64GA220G-PA (frost white)	\$168.00/pr.
SV64GA231G-PA (fawn)	\$254.00/pr.
SV64GA325G-PA (metallic blue)	\$168.00/pr.
SV64GA334G-PA (dark met blue)	\$168.00/pr.
SV64GA343G-PA (dark met blue)	\$168.00/pr.
SV64GA418G-PA (aqua)	\$168.00/pr.
SV64GA419G-PA (aqua)	\$254.00/pr.
SV64GA508G-PA (red)	\$168.00/pr.
SV64GA625G-PA (saddle)	\$168.00/pr.
SV64GA656G-PA (brown)	\$168.00/pr.

1965 Cutlass & 442 (Madrid Grain)

SV65GA100G-PA (black)	\$168.00/pr.
SV65GA140G-PA (slate)	\$168.00/pr.
SV65GA206G-PA (white)	\$168.00/pr.
SV65GA220G-PA (frost white)	\$168.00/pr.
SV65GA232G-PA (fawn)	\$254.00/pr.
SV65GA235G-PA (fawn)	\$168.00/pr.
SV65GA239G-PA (met parchment)	\$168.00/pr.
SV65GA314G-PA (sterling blue)	\$254.00/pr.
SV65GA325G-PA (light met blue)	\$168.00/pr.
SV65GA343G-PA (dark met blue)	\$168.00/pr.
SV65GA420G-PA (met turquoise)	\$168.00/pr.
SV65GA448G-PA (dk met turquoise)	\$168.00/pr.
SV65GA501G-PA (red)	\$168.00/pr.
SV65GA506G-PA (dark met red)	\$168.00/pr.
SV65GA520G-PA (metallic red)	\$168.00/pr.
SV65GA528G-PA (red)	\$168.00/pr.
SV65GA642G-PA (gold)	\$168.00/pr.
SV65GA677G-PA (met brown)	\$254.00/pr.
SV65GA679G-PA (saddle)	\$168.00/pr.
SV65GA710G-PA (buckskin)	\$168.00/pr.

1966-67 Cutlass & 442 (Madrid Grain)

SV66GA100G-PA (black)	\$168.00/pr.
SV66GA220G-PA (frost white)	\$168.00/pr.
SV66GA235G-PA (fawn)	\$168.00/pr.
SV66GA239G-PA (met parchment)	\$168.00/pr.
SV66GA240G-PA (parchment)	\$168.00/pr.
SV66GA310G-PA (metallic blue)	\$168.00/pr.
SV66GA325G-PA (light met blue)	\$168.00/pr.
SV66GA338G-PA (bright blue)	\$168.00/pr.
SV66GA343G-PA (dark met blue)	\$168.00/pr.
SV66GA420G-PA (metallic aqua)	\$168.00/pr.
SV66GA421G-PA (dark met aqua)	\$168.00/pr.
SV66GA424G-PA (met turquoise)	\$168.00/pr.
SV66GA425G-PA (turquoise)	\$168.00/pr.
SV66GA448G-PA (dk met turquoise)	\$168.00/pr.
SV66GA515G-PA (burgundy)	\$168.00/pr.
SV66GA520G-PA (metallic red)	\$168.00/pr.
SV66GA521G-PA (bronze)	\$254.00/pr.
SV66GA526G-PA (bronze)	\$254.00/pr.
SV66GA528G-PA (red)	\$168.00/pr.
SV66GA631G-PA (metallic bronze)	\$168.00/pr.
SV66GA640G-PA (pearl yellow)	\$168.00/pr.
SV66GA651G-PA (metallic gold)	\$168.00/pr.
SV66GA680G-PA (saddle)	\$168.00/pr.

1964-72 HARDTOP SUNVISOR SUPPORTS

Chrome sunvisor support with correct tension screw to insure an accurate fit for original and reproduction sunvisors.



**1964-72 Cutlass & 442
SV64GA-SUPPORT**..... \$29.00/ea.

SUNVISOR TIP & BUSHING KIT



Sunvisor tips with sleeves for 1964-72 models with double pin sunvisors and a center mounted sunvisor retainer over the rearview mirror. Set includes 2 rubber tips and 2 plastic sleeves.

SVTIP-KIT.....\$10.00/kit

1968 Cutlass & 442 (Madrid Grain)

SV68GA100G-PA (black)	\$168.00/pr.
SV68GA135G-PA (platinum)	\$168.00/pr.
SV68GA204G-PA (met parchment)	\$168.00/pr.
SV68GA220G-PA (frost white)	\$168.00/pr.
SV68GA331G-PA (metallic blue)	\$168.00/pr.
SV68GA332G-PA (light met blue)	\$168.00/pr.
SV68GA333G-PA (teal blue)	\$168.00/pr.
SV68GA429G-PA (turquoise)	\$168.00/pr.
SV68GA501G-PA (red)	\$168.00/pr.
SV68GA502G-PA (red)	\$168.00/pr.
SV68GA645G-PA (willow gold)	\$168.00/pr.
SV68GA709G-PA (buckskin)	\$168.00/pr.

1969 Cutlass & 442 (Madrid Grain)

SV69GA100G-PA (black)	\$168.00/pr.
SV69GA235G-PA (parchment)	\$168.00/pr.
SV69GA239G-PA (met parchment)	\$168.00/pr.
SV69GA325G-PA (light met blue)	\$168.00/pr.
SV69GA369G-PA (dark met blue)	\$168.00/pr.
SV69GA469G-PA (metallic green)	\$168.00/pr.
SV69GA503G-PA (red)	\$168.00/pr.
SV69GA511G-PA (red)	\$168.00/pr.
SV69GA513G-PA (red)	\$168.00/pr.
SV69GA635G-PA (gold)	\$168.00/pr.
SV69GA710G-PA (buckskin)	\$168.00/pr.

1970-72 Cutlass & 442 (Madrid Grain)

SV70GA100G-PA (black)	\$168.00/pr.
SV70GA138G-PA (pewter)	\$168.00/pr.
SV70GA202G-PA (pearl white)	\$168.00/pr.
SV70GA230G-PA (white)	\$168.00/pr.
SV70GA310G-PA (lt met blue)	\$168.00/pr.
SV70GA342G-PA (metallic blue)	\$168.00/pr.
SV70GA380G-PA (blue)	\$168.00/pr.
SV70GA415G-PA (jade green)	\$168.00/pr.
SV70GA460G-PA (metallic green)	\$168.00/pr.
SV70GA465G-PA (green)	\$168.00/pr.
SV70GA513G-PA (red)	\$168.00/pr.
SV70GA650G-PA (gold)	\$168.00/pr.
SV70GA657G-PA (sienna)	\$168.00/pr.
SV70GA658G-PA (burnt saddle)	\$168.00/pr.
SV70GA670G-PA (saddle)	\$168.00/pr.
SV70GA683G-PA (saddle)	\$168.00/pr.
SV70GA690G-PA (saddle)	\$168.00/pr.
SV70GA694G-PA (sandalwood)	\$168.00/pr.
SV70GA695G-PA (sandalwood)	\$168.00/pr.
SV70GA697G-PA (sandalwood)	\$168.00/pr.

CONVERTIBLE SUNVISOR BRACKETS



Diecast, high-strength, chromed to perfection. Guaranteed in fit and function to be identical to the original GM part.

**1964-65 Cutlass & 442
SV64GA-BRACKET**..... \$139.00/pr.

**1966-67 Cutlass & 442
SV66GA-BRACKET**.....\$99.00/pr.





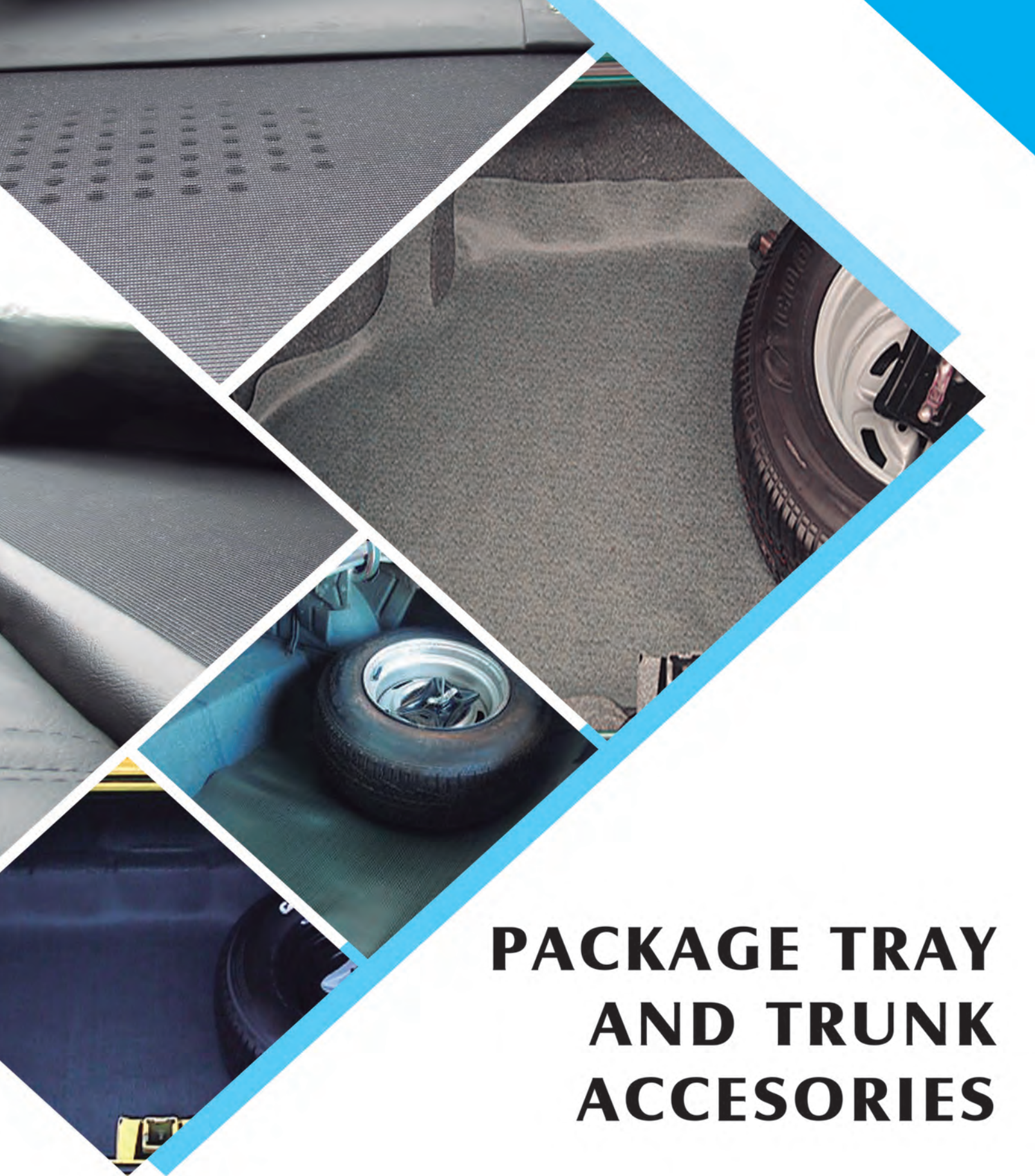

**1968-72 Cutlass & 442
SV68GA-BRACKET**.....\$99.00/pr.





PACKAGE TRAY AND TRUNK ACCESORIES

 facebook.com/legendaryautointeriors
 twitter.com/legendaryautoin

 www.legendaryautointeriors.com
 instagram.com/legendaryautointeriorsltd
 youtube.com/user/legendaryauto

PACKAGE TRAYS AND JUTE INSULATION

Die-cut to original specifications, these reproductions of the original panels go between the top of the rear seat and the back window. Colors are year specific and are available with or without speaker grill cutouts. Die-cut jute insulation helps reduce the amount of noise and heat that would come from the trunk compartment.

1964-65 F-85, Cutlass & 442 (Sports Coupe)

(Without Cuts)	
PT64GUS01N (black)	\$79.00/ea.
PT64GUS07N (dark blue)	\$79.00/ea.
PT64GUS13N (dark green)	\$79.00/ea.
PT64GUS18N (light blue)	\$79.00/ea.
PT64GUS23N (tan)	\$79.00/ea.
PT64GUS25N (dark brown)	\$79.00/ea.
PT64GUS32N (gold)	\$79.00/ea.
(With Cuts)	
PT64GUS01 (black)	\$119.00/ea.
PT64GUS03 (red)	\$119.00/ea.
PT64GUS07 (dark blue)	\$119.00/ea.
PT64GUS13 (dark green)	\$119.00/ea.
PT64GUS18 (light blue)	\$119.00/ea.
PT64GUS23 (tan)	\$119.00/ea.
PT64GUS25 (dark brown)	\$119.00/ea.
PT64GUS31 (maroon)	\$119.00/ea.
PT64GUS32 (gold)	\$119.00/ea.

Will fit both 2 & 4-door models.

1964 Cutlass & 442 (Holiday Coupe)

(Without Cuts)	
PT64GU100GN (black)	\$79.00/ea.
PT64GU325GN (metallic blue)	\$79.00/ea.
PT64GU406GN (green)	\$79.00/ea.
PT64GU508GN (red)	\$79.00/ea.
PT64GU656GN (brown)	\$79.00/ea.
(With Cuts)	
PT64GU100G (black)	\$119.00/ea.
PT64GU325G (metallic blue)	\$119.00/ea.
PT64GU406G (green)	\$119.00/ea.
PT64GU508G (red)	\$119.00/ea.
PT64GU656G (brown)	\$119.00/ea.
PT64GUJ (jute insulation)	\$25.00/ea.

1965 Cutlass & 442 (Holiday Coupe)

(Without Cuts)	
PT64GU100GN (black)	\$79.00/ea.
PT64GU314GN (sterling blue)	\$79.00/ea.
PT64GU528GN (red)	\$79.00/ea.
PT64GU710GN (buckskin)	\$79.00/ea.
(With Cuts)	
PT64GU100G (black)	\$119.00/ea.
PT64GU314G (sterling blue)	\$119.00/ea.
PT64GU528G (red)	\$119.00/ea.
PT64GU710G (buckskin)	\$119.00/ea.
PT64GUJ (jute insulation)	\$25.00/ea.

1966 Cutlass & 442 (Holiday Coupe)

(Without Cuts)	
PT66GU100GN (black)	\$79.00/ea.
PT66GU325GN (metallic blue)	\$79.00/ea.
PT66GU521GN (metallic red)	\$79.00/ea.
PT66GU528GN (red)	\$79.00/ea.
(With Cuts)	
PT66GU100G (black)	\$119.00/ea.
PT66GU325G (metallic blue)	\$119.00/ea.
PT66GU521G (metallic red)	\$119.00/ea.
PT66GU528G (red)	\$119.00/ea.
PT66GUJ (jute insulation)	\$25.00/ea.

1967 Cutlass & 442 (Holiday Coupe)

(Without Cuts)	
PT66GU100GN (black)	\$79.00/ea.
PT66GU310GN (light metallic blue)	\$79.00/ea.
PT66GU521GN (metallic red)	\$79.00/ea.
PT66GU528GN (red)	\$79.00/ea.
(With Cuts)	
PT66GU100G (black)	\$119.00/ea.
PT66GU310G (light metallic blue)	\$119.00/ea.
PT66GU521G (metallic red)	\$119.00/ea.
PT66GU528G (red)	\$119.00/ea.
PT66GUJ (jute insulation)	\$25.00/ea.

1966-67 F-85 & Cutlass (Sports & Club Cpe)

(4 Door Without Cuts)	
PT66GU4D01N (black)	\$79.00/ea.
PT66GU4D03N (red)	\$79.00/ea.
PT66GU4D07N (dark blue)	\$79.00/ea.
PT66GU4D13N (dark green)	\$79.00/ea.
PT66GU4D18N (light blue)	\$79.00/ea.
PT66GU4D23N (tan)	\$79.00/ea.
PT66GU4D25N (dark brown)	\$79.00/ea.
PT66GU4D31N (maroon)	\$79.00/ea.
PT66GU4D32N (gold)	\$79.00/ea.
(4 Door With Cuts)	
PT66GU4D01 (black)	\$119.00/ea.
PT66GU4D03 (red)	\$119.00/ea.
PT66GU4D07 (dark blue)	\$119.00/ea.
PT66GU4D13 (dark green)	\$119.00/ea.
PT66GU4D18 (light blue)	\$119.00/ea.
PT66GU4D23 (tan)	\$119.00/ea.
PT66GU4D25 (dark brown)	\$119.00/ea.
PT66GU4D31 (maroon)	\$119.00/ea.
PT66GU4D32 (gold)	\$119.00/ea.
PT66GU4DJ (jute insulation)	\$25.00/ea.

PACKAGE TRAYS & JUTE INSULATION CONT.

1968-72 F-85 & Cutlass (Sports & Club Cpe)
(4 Door Without Cuts) 

PT68GU4D01N (black).....	\$79.00/ea.
PT68GU4D03N (red).....	\$79.00/ea.
PT68GU4D07N (dark blue).....	\$79.00/ea.
PT68GU4D13N (dark green).....	\$79.00/ea.
PT68GU4D18N (light blue).....	\$79.00/ea.
PT68GU4D23N (tan).....	\$79.00/ea.
PT68GU4D25N (dark brown).....	\$79.00/ea.
PT68GU4D31N (maroon).....	\$79.00/ea.
PT68GU4D32N (gold).....	\$79.00/ea.
(4 Door With Cuts)	
PT68GU4D01 (black).....	\$119.00/ea.
PT68GU4D03 (red).....	\$119.00/ea.
PT68GU4D07 (dark blue).....	\$119.00/ea.
PT68GU4D13 (dark green).....	\$119.00/ea.
PT68GU4D18 (light blue).....	\$119.00/ea.
PT68GU4D23 (tan).....	\$119.00/ea.
PT68GU4D25 (dark brown).....	\$119.00/ea.
PT68GU4D31 (maroon).....	\$119.00/ea.
PT68GU4D32 (gold).....	\$119.00/ea.

1968 Cutlass Supreme (Holiday Cpe) 
(Without Cuts)

PT68GU442100GN (black).....	\$79.00/ea.
PT68GU442332GN (metallic blue).....	\$79.00/ea.
PT68GU442333GN (teal blue).....	\$79.00/ea.
PT68GU442502GN (dark red).....	\$79.00/ea.
PT68GU442645GN (willow gold).....	\$79.00/ea.
(With Cuts)	
PT68GU442100G (black).....	\$119.00/ea.
PT68GU442332G (metallic blue).....	\$119.00/ea.
PT68GU442333G (teal blue).....	\$119.00/ea.
PT68GU442502G (dark red).....	\$119.00/ea.
PT68GU442645G (willow gold).....	\$119.00/ea.
PT68GU442J (jute insulation).....	\$25.00/ea.

1969 Cutlass Supreme (Holiday Cpe) 
(Without Cuts)

PT68GU442100GN (black).....	\$79.00/ea.
PT68GU442325GN (metallic blue).....	\$79.00/ea.
PT68GU442432GN (metallic green).....	\$79.00/ea.
PT68GU442511GN (red).....	\$79.00/ea.
PT68GU442635GN (gold).....	\$79.00/ea.
(With Cuts)	
PT68GU442100G (black).....	\$119.00/ea.
PT68GU442325G (metallic blue).....	\$119.00/ea.
PT68GU442432G (metallic green).....	\$119.00/ea.
PT68GU442511G (red).....	\$119.00/ea.
PT68GU442635G (gold).....	\$119.00/ea.
PT68GU442J (jute insulation).....	\$25.00/ea.

1968-70 Cutlass S & 442 (Holiday Cpe) 
(Without Cuts)

PT68GU442100GN (black).....	\$79.00/ea.
PT68GU442310GN (light met blue).....	\$79.00/ea.
PT68GU442325GN (metallic blue).....	\$79.00/ea.
PT68GU442332GN (metallic blue).....	\$79.00/ea.
PT68GU442333GN (teal blue).....	\$79.00/ea.
PT68GU442380GN (blue).....	\$79.00/ea.
PT68GU442415GN (jade green).....	\$79.00/ea.
PT68GU442432GN (light met green).....	\$79.00/ea.
PT68GU442460GN (metallic green).....	\$79.00/ea.
PT68GU442465GN (green).....	\$79.00/ea.
PT68GU442502GN (dark red).....	\$79.00/ea.
PT68GU442511GN (red).....	\$79.00/ea.
PT68GU442635GN (gold).....	\$79.00/ea.
PT68GU442645GN (willow gold).....	\$79.00/ea.
PT68GU442650GN (gold).....	\$79.00/ea.
PT68GU442657GN (sienna).....	\$79.00/ea.
PT68GU442690GN (saddle).....	\$79.00/ea.

1968-70 Cutlass S & 442 (Holiday Cpe) 
(With Cuts)

PT68GU442100G (black).....	\$119.00/ea.
PT68GU442310G (light met blue).....	\$119.00/ea.
PT68GU442325G (metallic blue).....	\$119.00/ea.
PT68GU442332G (metallic blue).....	\$119.00/ea.
PT68GU442333G (teal blue).....	\$119.00/ea.
PT68GU442380G (blue).....	\$119.00/ea.
PT68GU442415G (jade green).....	\$119.00/ea.
PT68GU442432G (light met green).....	\$119.00/ea.
PT68GU442460G (metallic green).....	\$119.00/ea.
PT68GU442465G (green).....	\$119.00/ea.
PT68GU442502G (dark red).....	\$119.00/ea.
PT68GU442511G (red).....	\$119.00/ea.
PT68GU442635G (gold).....	\$119.00/ea.
PT68GU442645G (willow gold).....	\$119.00/ea.
PT68GU442650G (gold).....	\$119.00/ea.
PT68GU442657G (sienna).....	\$119.00/ea.
PT68GU442690G (saddle).....	\$119.00/ea.
PT68GU442J (jute insulation).....	\$25.00/ea.

1971 Cutlass S & 442 (Hardtop Cpe) 
(Without Cuts)

PT68GU442100GN (black).....	\$79.00/ea.
PT68GU442310GN (light met blue).....	\$79.00/ea.
PT68GU442325GN (metallic blue).....	\$79.00/ea.
PT68GU442332GN (metallic blue).....	\$79.00/ea.
PT68GU442333GN (teal blue).....	\$79.00/ea.
PT68GU442380GN (blue).....	\$79.00/ea.
PT68GU442415GN (jade green).....	\$79.00/ea.
PT68GU442432GN (light met green).....	\$79.00/ea.
PT68GU442460GN (metallic green).....	\$79.00/ea.
PT68GU442502GN (dark red).....	\$79.00/ea.
PT68GU442511GN (red).....	\$79.00/ea.
PT68GU442635GN (gold).....	\$79.00/ea.
PT68GU442645GN (willow gold).....	\$79.00/ea.
PT68GU442650GN (gold).....	\$79.00/ea.
PT68GU442657GN (sienna).....	\$79.00/ea.

(With Cuts)

PT68GU442100G (black).....	\$119.00/ea.
PT68GU442310G (light met blue).....	\$119.00/ea.
PT68GU442325G (metallic blue).....	\$119.00/ea.
PT68GU442332G (metallic blue).....	\$119.00/ea.
PT68GU442333G (teal blue).....	\$119.00/ea.
PT68GU442380G (blue).....	\$119.00/ea.
PT68GU442415G (jade green).....	\$119.00/ea.
PT68GU442432G (light met green).....	\$119.00/ea.
PT68GU442460G (metallic green).....	\$119.00/ea.
PT68GU442502G (dark red).....	\$119.00/ea.
PT68GU442511G (red).....	\$119.00/ea.
PT68GU442635G (gold).....	\$119.00/ea.
PT68GU442645G (willow gold).....	\$119.00/ea.
PT68GU442650G (gold).....	\$119.00/ea.
PT68GU442657G (sienna).....	\$119.00/ea.
PT68GU442J (jute insulation).....	\$25.00/ea.

1972 Cutlass S & 442 (Hardtop Cpe) 
(Without Cuts)

PT68GU442100GN (black).....	\$79.00/ea.
PT68GU442310GN (light met blue).....	\$79.00/ea.
PT68GU442325GN (metallic blue).....	\$79.00/ea.
PT68GU442332GN (metallic blue).....	\$79.00/ea.
PT68GU442333GN (teal blue).....	\$79.00/ea.
PT68GU442380GN (blue).....	\$79.00/ea.
PT68GU442432GN (light met green).....	\$79.00/ea.
PT68GU442460GN (metallic green).....	\$79.00/ea.
PT68GU442465GN (green).....	\$79.00/ea.
PT68GU442502GN (dark red).....	\$79.00/ea.
PT68GU442511GN (red).....	\$79.00/ea.
PT68GU442635GN (gold).....	\$79.00/ea.
PT68GU442645GN (willow gold).....	\$79.00/ea.
PT68GU442650GN (gold).....	\$79.00/ea.
PT68GU442690GN (saddle).....	\$79.00/ea.

(With Cuts)

PT68GU442100G (black).....	\$119.00/ea.
PT68GU442310G (light met blue).....	\$119.00/ea.
PT68GU442325G (metallic blue).....	\$119.00/ea.
PT68GU442332G (metallic blue).....	\$119.00/ea.
PT68GU442333G (teal blue).....	\$119.00/ea.
PT68GU442380G (blue).....	\$119.00/ea.
PT68GU442432G (light met green).....	\$119.00/ea.
PT68GU442460G (metallic green).....	\$119.00/ea.
PT68GU442465G (green).....	\$119.00/ea.
PT68GU442502G (dark red).....	\$119.00/ea.
PT68GU442511G (red).....	\$119.00/ea.
PT68GU442635G (gold).....	\$119.00/ea.
PT68GU442645G (willow gold).....	\$119.00/ea.
PT68GU442650G (gold).....	\$119.00/ea.
PT68GU442690G (saddle).....	\$119.00/ea.
PT68GU442J (jute insulation).....	\$25.00/ea.

1970 Cutlass Supreme (Holiday Cpe)

1971-72 Cutlass Supreme (Hardtop Cpe) 
(With Cuts)

PT70GU100G (black).....	\$119.00/ea.
PT70GU310G (light met blue).....	\$119.00/ea.
PT70GU380G (blue).....	\$119.00/ea.
PT70GU415G (jade green).....	\$119.00/ea.
PT70GU460G (metallic green).....	\$119.00/ea.
PT70GU465G (green).....	\$119.00/ea.
PT70GU650G (gold).....	\$119.00/ea.
PT70GU657G (sienna).....	\$119.00/ea.
PT70GU658G (burnish saddle).....	\$119.00/ea.
PT70GU690G (saddle).....	\$119.00/ea.
PT70GUJ (jute insulation).....	\$25.00/ea.

TRUNK MATS

Original style rubber trunk mats die-cut to factory specifications to assure a correct fit. Please specify material pattern at time of order.

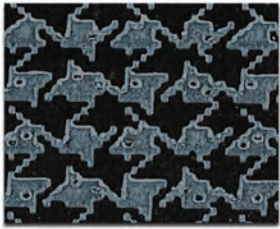

Houndstooth



Green/Gray

TRUNK MATS

Original style rubber trunk mats feature correct backings and are die-cut from factory specifications to assure a correct fit. Available in original patterns and colors.

1964-65 Cutlass & 442

TM64GU-GHT (Gray Houndstooth).....\$89.00/ea.

TM64GU-AHT (Aqua Houndstooth).....\$89.00/ea.

1966-67 Cutlass & 442

TM66GU-GHT (Gray Houndstooth).....\$89.00/ea.

TM66GU-AHT (Aqua Houndstooth).....\$89.00/ea.

1968 Cutlass, Supreme & 442

TM68GU-GHT (Gray Houndstooth).....\$89.00/ea.

TM68GU-AHT (Aqua Houndstooth).....\$89.00/ea.

1969 Cutlass, Supreme & 442

TM69GU-G (Green/Gray).....\$89.00/ea.

1970-72 Cutlass, Supreme & 442

TM70GU-G (Green/Gray).....\$69.00/ea.

TRUNK DIVIDERS & JUTE INSULATION

Die-cut reproductions of the black fiberboard panel that separates the trunk compartment from the passenger area. Trunk divider jute padding is recommended to provide insulation from moisture and reduces the amount of heat and noise from the trunk compartment.



1964-67 Cutlass & 442

TD64GU (Coupe models).....\$35.00/ea.

TD64GUJ (jute insulation).....\$26.00/ea.

1968-72 Cutlass & 442

TD68GU (Coupe models).....\$35.00/ea.

TD68GUJ (jute insulation).....\$26.00/ea.

SPARE TIRE COVER

Add the finishing touch to your trunk with a spare tire cover to match your trunk mat. Made from the same trunk mat material, these covers will fit any vehicle with a floor mounted spare tire. Please specify material pattern at time of order.

1964-68 Cutlass & 442

ST64GU-14GHT (14" Gray Houndstooth) ...\$59.00/ea.

ST64GU-15GHT (15" Gray Houndstooth) ...\$59.00/ea.

ST64GU-14AHT (14" Aqua Houndstooth) ...\$59.00/ea.

ST64GU-15AHT (15" Aqua Houndstooth) ...\$59.00/ea.

1969-72 Cutlass & 442

ST69GU-G (Green/Gray)\$59.00/ea.

SPARE TIRE BOARD

Die-cut reproduction lid for your spare tire. These lids are made with the same patterns as the trunk mats and were used when the spare tire cover was not ordered.

1964-67 Cutlass & 442

ST64GU-GHT (Gray Houndstooth).....\$29.00/ea.

ST64GU-AHT (Aqua Houndstooth).....\$29.00/ea.

TRUNK MAT MATERIAL

Legendary Auto Interiors offers an uncut roll of trunk mat material in Houndstooth, Green/Gray or Herringbone for models not offered. You cut to size this 52" x 80" roll.

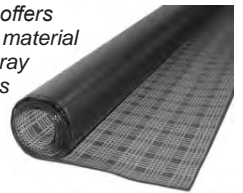

TMROLLHT (Gray Houndstooth)\$59.00/ea.

TMROLLAHT (Aqua Houndstooth).....\$89.00/ea.

TMROLLG (Green/Gray).....\$89.00/ea.

1964-72 TRUNK AREA SPEAKER COVER

Die-cut using laminated fiberboard just like the originals, these speaker covers are lined with jute insulator for an exact reproduction.



1964-65 Cutlass & 442



SC64GA (Coupe models).....\$29.00/ea.



1966-72 Cutlass & 442

SC66GA (Coupe models).....\$19.00/ea.



VINYL TOPS CONVERTIBLE TOPS AND ACCESORIES

 facebook.com/legendaryautointeriors
 twitter.com/legendaryautoin

 www.legendaryautointeriors.com
 instagram.com/legendaryautointeriorsltd
 youtube.com/user/legendaryauto



VINYL TOPS

Legendary Auto Interiors, Ltd. "fitted" vinyl tops are manufactured to original specifications with the correct 100% cotton drill backing that gives trouble free installation and long term durability. All seams are double stitched and die-electrically heat-sealed insuring accurate deck width and seam durability. Each top is individually cut and fit for each specific year, make and model to give that perfect Legendary fit. Every Legendary vinyl top carries a (5) year factory warranty, the best in the industry!!

VINYL TOPS

1964-65 F-85, Cutlass & 442

VTL28GA01S (satin black)..... \$379.00/ea.
 VTL28GA02S (satin white)..... \$379.00/ea.

1966-67 F-85, Cutlass & 442

VTL29GA01S (satin black)..... \$379.00/ea.
 VTL29GA02S (satin white) (shown)... \$379.00/ea.

1968-69 Cutlass S, & 442

VTL33GU01S (satin black)..... \$379.00/ea.
 VTL33GU02S (satin white)..... \$379.00/ea.

1970-71 Cutlass S, & 442

VTL34GU01S (satin black)..... \$379.00/ea.
 VTL34GU02S (satin white)..... \$379.00/ea.

1972 Cutlass S, & 442

VTL34GU01G (gloss black) \$379.00/ea.
 VTL34GU02G (gloss white) \$379.00/ea.

1970-71 Cutlass Supreme "Halo"

VTL35GU01S (satin black)..... \$379.00/ea.
 VTL35GU02S (satin white)..... \$379.00/ea.

1972 Cutlass Supreme

VTL36GU01G (gloss black) \$379.00/ea.
 VTL36GU02G (gloss white) \$379.00/ea.

☞ Valance is not sewn to the side sails.

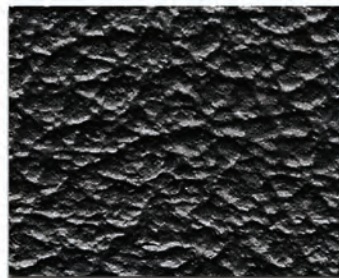

Levant Grain
(Black)

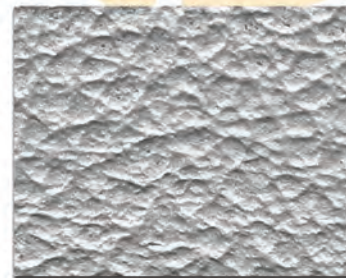

Levant Grain
(White)

NOS VINYL TOPS

Oldsmobile offered a variety of vinyl top colors other than black and white for F-85, Cutlass & 442 models. Colors such as blue, teal, green, gold and buckskin have not yet been reproduced. In our efforts to better serve you in your restoration needs, NOS (New Old Stock) vinyl top material is continuously being looked for. Please call for more information.

VTNOS\$1129.00/ea.

☞ Please specify year/make/model and color at time of order.

Convertible Top Color Samples

K.V. "Pinpoint Grain"



01 Black



02 White

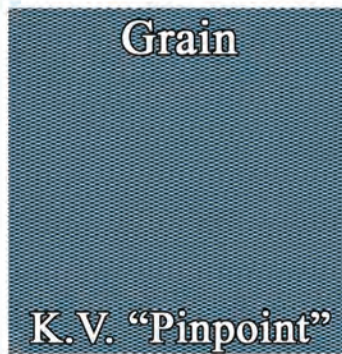

CONVERTIBLE TOPS



1966 Oldsmobile 442 convertible

1964-65 Cutlass & 442

CT64GA(C)T (Black and White only) \$399.00/ea.
CT64GA-P (Plastic curtain only) \$229.00/ea.

1968-72 Cutlass & 442

CT68GAC)T (Black and White only) \$399.00/ea.
CG68GA(C) (Glass curtain only)..... \$244.00/ea.

1966-67 Cutlass & 442

CT66GA(C)T (Black and White only) \$399.00/ea.
CT66GA-P (Plastic curtain only) \$229.00/ea.

CONVERTIBLE TOPS AND ACCESSORIES



Legendary Auto Interiors, Ltd. convertible tops are reproduced to factory original specifications using correct heavyweight 36oz. material. Convertible tops are available in the original KV "Pinpoint" grain on all 1964-72 Cutlass & 442 models. Rear window curtains are available in glass or plastic depending on year and model. We also have convertible tops available for many other models. For colors other than black and white and models not listed, please call for assistance. As with all Legendary Auto Interiors, Ltd. products, these reproduction convertible tops are the finest available and come with a (2) year manufacturer's warranty (glass curtains come with a (1) year warranty) against defects in materials and workmanship.

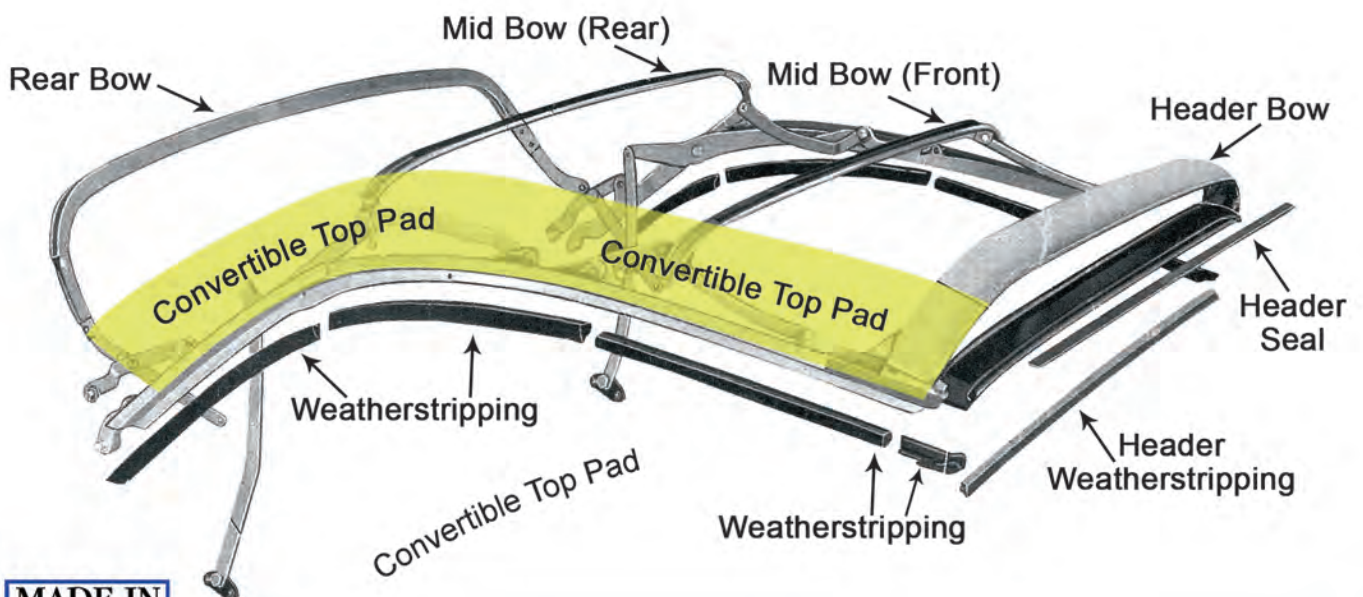

CONVERTIBLE TOP PADS

Universal convertible top pads fit between the top and metal frame rails, protecting the top from wear and damage. Highly recommended with installation of new convertible tops.



CTPAD74STD (1964-67).....\$79.00/pr.
CTPAD68GA (1968-72).....\$52.00/pr.

1964-67 CONVERTIBLE TOP MOTOR COVER

Die-cut black laminated fiber board motor cover has been shape-formed to fit exactly like the original.



1964-67 Cutlass & 442 
TP64GA.....\$10.00/ea.

CONVERTIBLE TOP TENSION CABLES

These tension cables install into the cable sleeves that are sewn into the convertible top keeping it secure to the top frame.



1964-65 Cutlass & 442
CT64GA-CABLE.....\$69.00/pr.
1966-67 Cutlass & 442
CT66GA-CABLE.....\$69.00/pr.
1968-72 Cutlass & 442
CT68GA-CABLE.....\$49.00/pr.

1968-72 CONVERTIBLE HEADER PANEL VINYL

Pre-cut Madrid grain header vinyl wraps over the header bow that attaches to the front of the convertible top frame. Please specify year and color at time of order.



1968-72 Cutlass & 442
VV68GAHEADER(C).....\$29.00/ea.

1964-72 CONVERTIBLE TOP LATCH HOOKS

Case-hardened steel reproduction hooks secure the top to the upper windshield framing. Chrome plated with pin-holed rubber punch mounting insert included.



1964-72 Cutlass & 442
CT64GA-HOOK.....\$10.00/ea.

1964-65 & 1968-72 CONVERTIBLE TOP GUIDE PIN

These chrome plated pins screw into the top frame and slide into the header panel aligning the convertible top with the front windshield.



1964-65 Cutlass & 442
1968-72 Cutlass & 442
CT64GA-GUIDE.....\$10.00/ea.

1964-72 CONVERTIBLE TOP LATCH HOOK KNUCKLES

Case-hardened steel reproductions are identical to the originals. These latch knuckles pivot at the front end of the latch assembly where the latch hooks (CT64GA-HOOK) thread into place. Complete with rolled press-on attaching pin.



1964-72 Cutlass & 442
CT64GA-KNUCKLE.....\$49.00/pr.

1966-67 CONVERTIBLE TOP PLASTIC GUIDE PINS

These reproduction plastic guide pins, also known as anti-rattle plates, help align the convertible top when latched into place with the windshield header panel.



1966-67 Cutlass & 442
CT66GA-GUIDE.....\$39.00/pr.

CONVERTIBLE BOOT DUST COVER

Protect your convertible boot with this convertible boot dust cover made in Levant grain with a satin finish. Comes in Black only



CB67MCBAG01.....\$72.00/ea.

CONVERTIBLE BOOTS

Legendary Auto Interior's convertible boots feature protective foam pockets and are sewn to original factory specifications. We are the only manufacturer making "as original" convertible boots using authentic grain vinyls and correct metal snaps or clips by year and model. 1964 models use Seville grain vinyl and 1965-72 models use Madrid grain vinyl. Every Legendary convertible boot carries a (5) year factory warranty, the best in the industry!



1969 Cutlass S convertible

1964 Cutlass & 442

CB64GA00017(C)

(All Colors).....\$358.00/ea.

CB64GAP0017(C) *(Plastic Clips)

(All Colors).....\$358.00/ea.

Ⓢ Plastic Clips are custom and therefore non-returnable, non-refundable

1964 (C) COLOR CODES

(100G) Black	(406G) Green
(206G) White	(508G) Red
(325G) Metallic Blue	(656G) Brown

1965 Cutlass & 442

CB65GA00017(C)

100G, 206G, 325G, 528G, 710G.....\$358.00/ea.

314G.....\$704.00/ea.

CB65GAP0017(C) *(Plastic Clips)

100G, 206G, 325G, 528G, 710G.....\$358.00/ea.

314G.....\$704.00/ea.

Ⓢ Plastic Clips are custom and therefore non-returnable, non-refundable

1965 (C) COLOR CODES

(100G) Black	(325G) Metallic Blue
(206G) White	(528G) Red
(314G) NOS Sterling Blue	(710G) Buckskin

1966 Cutlass & 442

CB66GA00017(C)

100G, 239G, 325G, 528G\$344.00/ea.

521G.....\$704.00/ea.

1966 (C) COLOR CODES

(100G) Black	(325G) Metallic Blue
(239G) Metallic Parchment	(521G) NOS Bronze
	(528G) Red

1967 Cutlass & 442

CB66GA00017(C)

(All Colors).....\$344.00/ea.

Ⓢ 240G Metallic Parchment requires sample approval.

1967 (C) COLOR CODES

(100G) Black	(310G) Light Metallic Blue
(240G) Metallic Parchment	(501G) Red
	(640G) Pearl Yellow

1968 Cutlass & 442

CB68GA00017(C)

(All Colors).....\$287.00/ea.

CB68GAE0017(C) (early 68 w/ clips)

(All Colors).....\$287.00/ea.

Ⓢ 332G Light Metallic Blue requires sample approval.

1968 (C) COLOR CODES

(100G) Black	(333G) Teal Blue
(204G) Metallic Parchment	(502G) Red
(332G) Light Metallic Blue	(645G) Willow Gold

1969 Cutlass & 442

CB68GA00017(C)

(All Colors).....\$287.00/ea.

1969 (C) COLOR CODES

(100G) Black	(511G) Red
(235G) Parchment	(635G) Gold
(325G) Metallic Blue	

1970 Cutlass & 442

CB68GA00017(C)

(All Colors).....\$287.00/ea.

1970 (C) COLOR CODES

(100G) Black	(460G) Metallic Green
(202G) Pearl White	(650G) Gold
(310G) Light Metallic Blue	(658G) Burnished Saddle

1971 Cutlass & 442

CB68GA00017(C)

(All Colors).....\$287.00/ea.

1971 (C) COLOR CODES

(100G) Black	(415G) Jade Green
(202G) Pearl White	(657G) Sienna
(380G) Blue	

1972 Cutlass & 442

CB68GA00017(C)

(All Colors).....\$287.00/ea.

1972 (C) COLOR CODES

(100G) Black	(690G) Saddle
(230G) White	

CONVERTIBLE WELL LINERS

These liners install behind the rear seat protecting your convertible top from wear and damage when placed in the down position. Legendary is the only manufacturer making factory exact well liners available today, backed by a (5) year factory warranty.



1968-72 Well Liner featuring factory correct "crosshatch" material

1964-65 Cutlass & 442

WL64GA00016100G (black).....\$207.00/ea.

Ⓢ No plastic strips or snaps. Staples to trim strip before convertible top is installed.

1966-67 Cutlass & 442

WL66GA00016100G (black).....\$207.00/ea.

Ⓢ Features a plastic attachment strip.

1968-72 Cutlass & 442

WL68GA00016100G (black).....\$244.00/ea.

Ⓢ Features a Rip-Stop plastic pocketed outer lining containing a thick layer of high loft felt. Our well liner is the only correct, as original reproduction well liner available. Ⓢ A LEGENDARY AUTO INTERIORS, LTD. EXCLUSIVE

CONVERTIBLE BODY SCREW STUDS



5/8" Phillips head stainless steel body screw studs for snap down boot and well liner applications.

CBBOOTBEZSCRW (Pkg/35).....\$16.00/pk.





WEATHERSTRIPING AND ACCESORIES

 facebook.com/legendaryautointeriors

 twitter.com/legendaryautoin

 www.legendaryautointeriors.com

 instagram.com/legendaryautointeriorsltd

 youtube.com/user/legendaryauto

Oldsmobile

DOOR WEATHERSTRIPPING

Thick molded rubber weatherstrip includes the necessary clips and correct molded endpads for an excellent fit. These pieces wrap around the bottom and sides of each door.

1964-65 F-85, Cutlass & 442
WS64GA-DOOR (Holiday Cpe. & Conv.)...\$99.00/pr.
WS64GA-DOORS (Sports Coupe).....\$99.00/pr.

1966-67 F-85, Cutlass & 442
WS66GA-DOOR (Holiday Cpe. & Conv.)...\$99.00/pr.
WS66GA-DOORS (Sports Coupe).....\$99.00/pr.

1968 Cutlass & 442
WS68GA-DOOR (Holiday Cpe. & Conv.)...\$99.00/pr.

1968-72 F-85, Cutlass & 442
WS68GA-DOORS (Sports Coupe).....\$99.00/pr.

1969-72 Cutlass & 442
WS69GA-DOOR (Holiday Cpe. & Conv.)...\$99.00/pr.

DOOR LOCK SEALS



These molded rubber "U" shaped seals screw onto the door jamb pillar to seal the front edge of the rear-down windows.

1964-65 Cutlass & 442 (Holiday Coupe & Conv.)
WS64GA-DOORLK.....\$39.00/pr.

1966-67 Cutlass & 442 (Holiday Coupe & Conv.)
WS66GA-DOORLK (shown).....\$49.00/pr.

1968-72 Cutlass & 442 (Holiday Coupe & Conv.)
WS68GA-DOORLK.....\$49.00/pr.

ROOF RAIL WEATHERSTRIPPING

Thick molded rubber with correct molded endpads. These start at the base of the windshield pillar post and follow along the outer edge of the roofline to the rear of the quarter window.



1964-65 Cutlass & 442
WS64GA-ROOF (Holiday Coupe).....\$99.00/pr.

1966-67 Cutlass & 442
WS66GA-ROOF (Holiday Coupe).....\$99.00/pr.

1968 Cutlass & 442
WS68GA-ROOF (Holiday Coupe).....\$89.00/pr.

1969-72 Cutlass & 442 (shown)
WS69GA-ROOF (Holiday Coupe).....\$99.00/pr.

HOOD-TO-COWL SEALS

This rubber piece seals the underside of the hood to the cowl. Installs on the front edge of the cowl area where the back edge of the hood meets.

1964-67 Cutlass & 442
WS64GA-HOOD\$29.00/ea.

1968-72 Cutlass & 442
WS68GA-HOOD\$29.00/ea.

REAR QUARTER WINDOW SEALS

These seals have a steel core molded inside the rubber and install into the chrome track located on the front edge of the rear roll-up quarter window.



1964-65 Cutlass & 442
WS64GA-QTRH (Holiday Coupe).....\$39.00/pr.

1964-65 Cutlass & 442
WS64GA-QTRC (Convertible)\$29.00/pr.

1966-67 Cutlass & 442
WS66GA-QTR (Holiday Cpe. & Conv.)\$39.00/pr.

1968-72 Cutlass & 442 (shown)
WS68GA-QTR (Holiday Cpe. & Conv.)\$39.00/pr.

TRUNK SEALS

Trunk seal kits feature correct original profile extruded foam for hardtop, sports coupe and convertible models. These seal the trunk lid preventing water leaks. 16" in length.



1964-72 Cutlass & 442
TS64GA.....\$29.00/ea.

HARDTOP / SEDAN WEATHERSTRIPPING

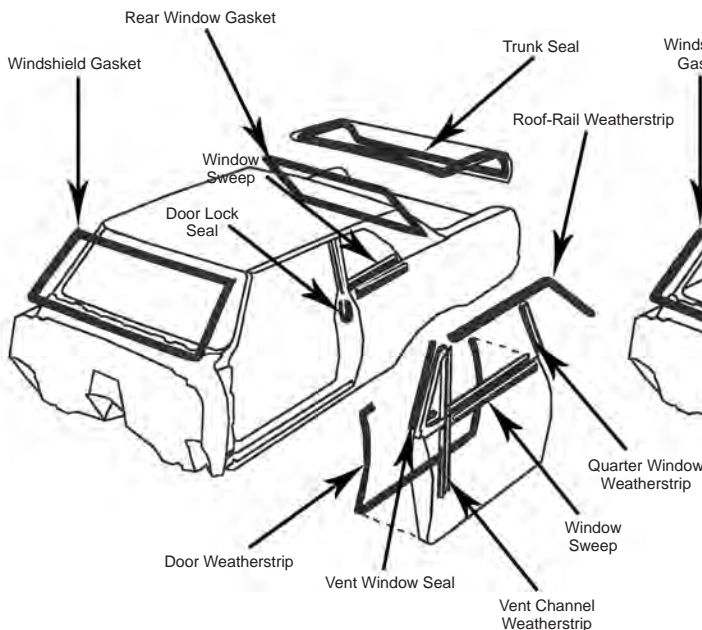

CONVERTIBLE WEATHERSTRIPPING

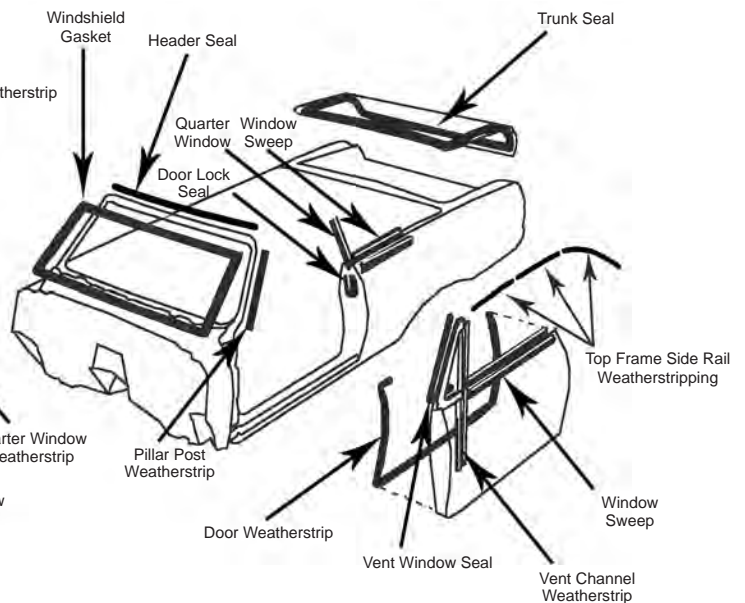

ORIGINAL-STYLE WINDOW SWEEP KITS

Original-style window felts are reproduced with a factory look half-rounded metal bead on the inner and outer channels. Available as complete sets of (8) weather-strips for inner and outer door glass and quarter glass on 2-door models.

1964 Cutlass & 442

WS64GUOWINDOWS (Sports Cpe.) \$149.00/kit

1965 Cutlass & 442

WS65GUOWINDOWH (Holiday Cpe.)... \$149.00/kit

WS65GUOWINDOWS (Sports Cpe.) \$149.00/kit

WS65GUOWINDOWC (Conv.)..... \$149.00/kit

1966-67 Cutlass & 442

WS66GUOWINDOWH (Holiday Cpe.)... \$179.00/kit

WS66GUOWINDOWS (Sports Cpe)..... \$179.00/kit

WS66GUOWINDOWC (Conv.)..... \$179.00/kit

1966-67 Cutlass Supreme

WS66GUOWINDOWHSP (Hol. Cpe.) .. \$179.00/kit

WS66GUOWINDOWCSP (Conv.)..... \$179.00/kit

1968 Cutlass, Cutlass Supreme & 442

WS68GUOWINDOWH (Holiday Cpe.)... \$179.00/kit

WS68GUOWINDOWS (Sports Cpe.) \$179.00/kit

WS68GUOWINDOWC (Conv.)..... \$179.00/kit

1969 Cutlass S, Cutlass Supreme & 442

WS69GUOWINDOWH (Holiday Cpe.)... \$179.00/kit

☞ Without belt molding

WS69GUOWINDOWS (Sports Cpe.) \$179.00/kit

WS69GUOWINDOWC (Conv.)..... \$179.00/kit

1970-72 Cutlass S & 442

WS70GUOWINDOWH (Holiday Cpe.)... \$179.00/kit

☞ With belt molding

1970-72 Cutlass Supreme

WS70GUOWINDOWHSP (Hol. Cpe.) .. \$179.00/kit

WS70GUOWINDOWCSP (Conv.)..... \$179.00/kit

HEADER SEALS

Rubber header seal runs along the front of the top and seals against the top of the windshield.

1964-65 Cutlass & 442

WS64GA-HS (Convertible).....\$29.00/ea.

1966-67 Cutlass & 442

WS66GA-HS (Convertible).....\$49.00/ea.

1968-72 Cutlass & 442

WS68GA-HS (Convertible).....\$69.00/ea.

PILLAR POST WEATHERSTRIPPING

These weatherstrip pieces run along the side of the windshield frame A-pillar.

1964-65 Cutlass & 442

WS64GA-WSP (Convertible).....\$69.00/pr.

1966-67 Cutlass & 442

WS66GA-WSP (Convertible).....\$69.00/pr.

1968 Cutlass & 442

WS68GA-WSP (Convertible).....\$69.00/pr.

1969-72 Cutlass & 442

WS69GA-WSP (Convertible).....\$89.00/pr.

CONVERTIBLE WEATHERSTRIPPING

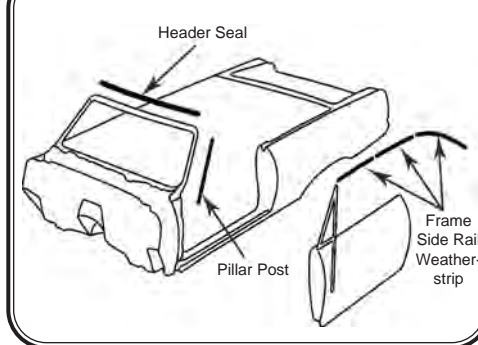

CONVERTIBLE TOP FRAME WEATHERSTRIPPING KITS

Complete convertible top frame kits consist of (1) rubber header seal and (6) molded rubber side rail pieces. (Header seal not shown)



1964-65 Cutlass & 442

WS64GA-ROOFC (Convertible)..... \$289.00/kit

1966-67 Cutlass & 442

WS66GA-ROOFC (Convertible)..... \$299.00/kit

1968-72 Cutlass & 442

WS68GA-ROOFC (Convertible)..... \$349.00/kit

PLASTIC HOOD PAD CLIPS



Reproduction plastic hood pad clips for all 1968-72 F-85, Cutlass & 442 models.

HPGA CLIP-P \$1.00/ea.

HOOD PAD INSULATION

Die-cut reproductions of the original hood pads come ready to install. These insulating pads help quiet engine noise and absorb heat.

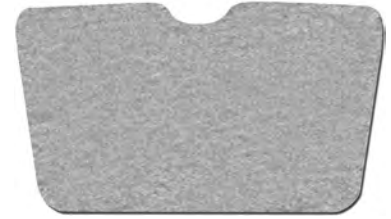

1964-65 Cutlass & 442

HP64GU (requires 7 clips).....\$39.00/ea.

1966 Cutlass & 442

HP66GU (requires 5 clips).....\$49.00/ea.

1967 Cutlass & 442

HP67GU (requires 5 clips).....\$49.00/ea.

1968-72 Cutlass & 442

HP68GU (requires 5 clips).....\$49.00/ea.

1970-72 Cutlass Supreme

HP70GUSP (requires 7 clips).....\$49.00/ea.

MOLDED HOOD PADS

These pads are molded to the shape of the hood like the originals. Due to the size of these hood pads, they must be shipped oversized.

1966 Cutlass & 442

HP66GUM (requires 5 clips).....\$229.00/ea.

1967 Cutlass & 442

HP67GUM (requires 5 clips).....\$229.00/ea.

1968-72 Cutlass & 442

HP68GUM (requires 5 clips).....\$119.00/ea.

1970-72 Cutlass Supreme

HP70GUSPM (requires 7 clips).....\$119.00/ea.

METAL HOOD PAD CLIPS



Reproduction of the original stamped metal hood pad clip for 1964-67 F-85, Cutlass & 442 models.

HPGA CLIP-M..... \$3.00/ea.



Providing the automotive industry
with the world's highest quality
soft trim products and services
RIGHT HERE AT HOME

**STILL ASSEMBLED AND
MADE IN THE** ★★★★★
USA 

THERE REALLY IS A DIFFERENCE!!

Legendary
AUTO INTERIORS LTD.®

www.legendaryautointeriors.com



ORDERING INFORMATION

HOW TO ORDER

MAIL, PHONE OR FAXES – When ordering by mail, please fill in all information on the order form that pertains to your vehicle. Print all information and include a telephone number where you can be reached during the day and evening. When ordering for more than one vehicle, please use separate order forms for each vehicle (see order forms in your Legendary Auto Interiors catalog). When ordering by phone, please have your customer number and a list of items ready. You may order conveniently by phone 8:00AM to 6:00PM EST Monday-Friday. Orders may also be sent in by fax 24 hours a day, 7 days a week. Please note that orders faxed in on Saturday or Sunday will not be received and processed until Monday. FAX: 1-800-732-8874

ON-LINE ORDERING – Legendary Auto Interiors, Ltd also offers convenient and easy on-line ordering 24 hours a day, 7 days a week at www.legendaryautointeriors.com. Click on the “Shop Online” tab in the options menu and follow the ordering procedures. Upon completion, Legendary Auto Interiors, Ltd will follow up with an email confirmation so you can verify that your order has been received correctly and is being processed. You may also choose to email your orders by contacting our sales department at sales@legendaryautointeriors.com.

METHODS OF PAYMENT

CREDIT CARDS – Legendary Auto Interiors, Ltd accepts Visa, MasterCard, American Express and Discover for your convenience. Please include the cardholder’s name, billing address, home and business phone, credit card number, expiration date and the 3 or 4 digit security code when placing your orders. Without this information it may slow the processing of your order.

CHECKS AND MONEY ORDERS – Personal Checks will be held 5 business days. To expedite your orders, we suggest paying by Certified Bank Check or Money Order. COD orders are no longer accepted. All payments MUST be in U.S. funds.

SHIPPING SERVICES

DOMESTIC SHIPPING - Legendary Auto Interiors Ltd utilizes both UPS and FedEx Ground for most U.S. parcel shipments which provides our customers the most efficient and cost effective shipping services available. We will ship by the best method for your geographic area unless otherwise specified. We also offer specialized shipping services such as 3 day Select, 2nd day air and Next Day Air for your convenience.

INTERNATIONAL SERVICES – We use the most current and most cost effective international parcel shipping companies available to provide both “Door to Airport” and “Door to Door” services to our overseas customers. We utilize UPS Canadian and FedEx International for Canadian shipments. This provides us with the best possible shipping and brokerage fees for our international customers.

DAMAGES AND SHORTAGES

The carrier is responsible for any merchandise lost or damaged in transit. **Should a package appear to be damaged, OPEN the package while the carrier’s driver is present and note all damages and/or shortages.** If this is not possible and you discover damaged goods or shortages, contact our Customer Service Department immediately! Damages and/or shortage claims must be made within 5 days of receipt of merchandise to ensure our ability to file a claim with the carrier. Please be sure to check all merchandise when you receive it and again before attempting installation.

Legendary Auto Interiors, Ltd. is committed to providing the highest possible level of customer service, however on rare occasions circumstances beyond our control can result in lost or damaged packages. To protect our customers against delays and having to make time consuming phone calls to the carrier, orders will incur a modest \$2.50 insurance fee on each shipment. In the event any products become lost or damaged we will then send replacement parts as quickly as possible, subject to material availability. We will also file the claims and deal with the carrier.

Carriers allow a short period of time to file claims. To take advantage of this service you must notify Legendary Auto Interiors, Ltd. of any damages within 5 days of receiving your delivery. Failure to contact us within this 5 day window will negate Legendary Auto Interiors further involvement.

RETURN POLICY

Legendary Auto Interiors Ltd. will accept the return of products for a full refund or exchange up to 30 days from the original invoice date with no re-stocking fee. Returns after a 30 day period, but before 60 days will be subject to a 25% restocking fee. No returns will be accepted after 60 days. Custom, Special Orders, Specialty Run Materials, Leather and NOS are not eligible for return under any circumstances other than a manufacturing defect. If any product is modified, altered, painted, installed or disassembled in any way without Legendary’s expressed written permission, the item is non-returnable. Legendary always recommends professional installation on all products. Any item which has been altered, painted, installed or deemed non-resalable by Legendary will be returned to the customer at the customer’s expense. Legendary is not responsible or liable for labor fees associated with the installation, modification or repair of any product purchased regardless of the circumstances.

RETURN GOOD INFORMATION

All returns must receive prior approval and an RMA (Return Merchandise Authorization) number prior to return shipping. Packages received by Legendary Auto Interiors Ltd. without prior approval and RMA number will be refused. Return shipping and insurance are the customers responsibility. All returned items must be received in as new condition. Examples that render a product non-returnable include, but are not limited to: evidence of attempted installation, parts that have been bent, broken, creased, scratched, soiled, melted or discolored. Also, we will not accept returns for any items that have been altered, painted, repaired or for any reason that has rendered the product non-returnable. Warning: Legendary is not responsible for damaged or lost packages returned by the customer.

CANADIAN CUSTOMER RETURNS

Warranty returns must be clearly marked as follows: **“U.S. GOODS BEING RETURNED FOR REPAIR OR REPLACEMENT UNDER WARRANTY COMMODITY CODE 9801:00V0”**.

PRICES

All prices effective December 31st, 2021 and are subject to change without notice.

HOURS

Monday – Friday 8:00AM to 6:00PM (Eastern Standard Time)

Saturday - By appointment only please

IMPORTANT ADDITIONAL INFORMATION

WARRANTY INFORMATION

Legendary Auto Interiors, Ltd proudly stands behind all of the products and services we offer. All Legendary manufactured interior soft trim products are backed by an exclusive **Limited Lifetime Warranty** for as long as you own your car. In addition, we offer a 5-year warranty on all of our molded and exterior soft trim products. Legendary Auto Interiors, Ltd also offers a huge selection of interior components, which we warranty for a minimum of 1 year in accordance with the original manufacturers product warranty. **Product Disclaimer: Normal wear from use or problems due to improper installation are excluded from any warranty.**

LEGENDARY GUARANTEE

All Legendary Auto Interiors, Ltd manufactured products are made to original specifications and are guaranteed to fit. In the event that you experience a problem with any of our products or are dissatisfied with our service, we will make every effort to resolve and correct your issue promptly and do our best to make sure that you are completely satisfied.

INTERIOR COLORS/GRAINS

Legendary Auto Interiors, Ltd offers one of the most diverse product lines available in the marketplace. We feature the correct "color matched" and "grain matching" materials for nearly all models and styles. Due to the extensive number of colors produced by Chrysler, AMC and General Motors, there are some colors, which are simply not available in reproduction form. As the demand for colors increases, we are constantly having previously unavailable colors reproduced. In the event that a vinyl or cloth is not available in reproduction form, the use of NOS material may be required. Please inquire for a current quote, as the price and availability of these NOS materials will vary. To ensure a correct color and grain match, your interior trim code may be required for verification. As color dye lots will vary, we recommend purchasing all your soft trim components at the same time to ensure an exact color match of all components throughout your interior. **Color and grain samples are available upon request at no charge.**

LEATHER INTERIORS

Legendary Auto Interiors, Ltd produces a large number of "as original" leather interiors that are color matched to the original. Special order custom leather interiors are also available upon request. Some applications may require a clean, non-faded sample to ensure the closest possible color match. Leather interior orders may require additional lead-time as well as additional costs, which will be quoted at time of your order. **Note: Due to the variable nature of real leather, minor marks and features are normal and add to the character & individuality of leather products.**

CUSTOM ORDERS

In addition to "As Original" reproduction interiors, Legendary Auto Interiors, Ltd specializes in and is proud to feature "CUSTOM" interiors servicing the Resto-Mod enthusiast. With the introduction of our new & exclusive *Legendary* product, custom orders have taken on an entirely new look and have given enthusiasts almost limitless options to create a one of a kind interior. Special Order and Custom interiors require approval for all designated materials being used and a signature approval on a "Custom Order" form is also required. Once the Custom work has been approved these orders must be prepaid and are Non-Returnable, Non-Refundable and Non-Cancelable.

INSTALLATION NOTES

Since age deteriorates certain areas of seats due to wear patterns and foam breakdown, certain adjustments and foam repair may be required to complete a perfect fit installation. For this reason, we recommend having a professional automotive interior trim/upholstery shop install your new Legendary Auto Interiors, Ltd soft trim products. As the manufacturer, we know how to install our products better than anyone and we offer complete installation services for both seat upholstery and door panels. For further information, see the **INSTALLATION GUIDE** included with your seat upholstery and door panels or the installation page of this catalog.

PRODUCT DEVELOPMENT & PATTERNS NEEDED

In an effort to develop new upholstery kits, door panels and other soft trim products we work hand in hand with many of our customers who provide their original parts for product development. These items must be ORIGINAL, in fair to good condition and have not been previously repaired or replaced in any way. Our Sales Department must be contacted directly before sending your old upholstery or other soft trim products to us. Since we have no idea about the usability of your parts until we receive them in, you may initially be asked to send photos in an effort to identify the condition of your original parts. Please remember that even if you send in your parts for inspection, we may not be able to use them. **PLEASE NOTE THAT OLD UPHOLSTERY AND OTHER SOFT TRIM ITEMS CANNOT BE RETURNED TO YOU, AS THEY WILL BE DISMANTLED FOR DEVELOPMENT USE.**

MAINTENANCE

All Legendary Auto Interiors, Ltd products may be cleaned with a mild soap and warm water solution. Never scrub or use any kind of harsh pads, brushes or detergents. After cleaning with mild soap and water, lightly clean again with an industrial grade wax and grease remover. (Contact your local auto parts store) Allow surface to dry. LIGHTLY mist with the vinyl protectant of your choice. Install your new parts into your cruising machine. Sit back, enjoy the ride and drive safely!! Note: On leather upholstery applications we recommend using a high-quality mink oil, neatsfoot oil and/or wax. Hand apply, let stand 30-60 minutes and then wipe /buff clean. LIGHTLY rub your soft trim product with oil and wipe excess oil from the surface. **DO NOT USE SILICONE BASED PRODUCTS** as they will deteriorate the thread and dry out leather.

INSTALLATION SERVICES

GM, CHRYSLER & AMC SEAT UPHOLSTERY

(Includes tear down of original upholstery and installation of new upholstery)



Front Buckets Install - \$500.00/pr.
(No Headrest Covers)



Front Buckets w/ Headrest Covers Install - \$600.00/pr.



Front Split Bench Install - \$575.00/ea.



Front Split Bench w/ Headrest Covers Install - \$675.00/ea.



Rear Bench Seat Install - \$400.00/ea.



Headrest Covers Install - \$150.00/pr.

Center Armrest Install - \$150.00/ea.
(for models w/ buckets and no console)



SAVE ON COMPLETE FRONT & REAR INSTALLS!!

Front Buckets & Rear Bench Seat Install - \$750.00/set

Front Buckets w/ Headrest Covers & Rear Bench Seat Install - \$850.00/set

Front Split Bench & Rear Bench Seat Install - \$825.00/set

Front Split Bench w/ Headrest Covers & Rear Bench Seat Install - \$925.00/set

NOTE* Basic installations DO NOT include new foam and cotton replacement or reconstruction, media blasting, painting, welding, frame straightening, polishing or trim detailing. These services are additional and available at an hourly rate. Please call for more details. **1-800-363-8804*

INSTALLATION SERVICES

GM, CHRYSLER & AMC DOOR PANELS

Basic Door Panel Installation

(Includes installation of metal rails and window weatherstrip)

**Convertible rear panel installation DOES NOT include ashtray/well covers
Ashtray/well covers for General Motors models are available. Call for details



Front Panels (Pair Only) - \$250.00/pr.



Hardtop/Convertible Rear Panels (Pair Only) - \$250.00/pr.

Complete Front & Rear Panels (Pairs Only) - \$500.00/pr.

Deluxe Door Panel Installation

(Includes installation of metal rails, window weatherstrip, metal trim and decorative emblems)

**Convertible rear panel installation DOES NOT include ashtray/well covers
Ashtray/well covers for General Motors models are available. Call for details



Front Panels (Pair Only) - \$400.00/pr.



Hardtop/Convertible Rear Panels (Pair Only) - \$325.00/pr.

Complete Front & Rear Panels (Pairs Only) - \$725.00/pr.

DOOR PANEL REFURBISHMENT

If we do not list your particular year/make/model vehicle, Legendary Auto Interiors, Ltd. can refurbish your panels back to original for you. The following refurbishing rates include installation of new panels (on your original metal rails), inner window weatherstripping, metal trim and decorative emblems. Please call for instructions before shipping your door panels.

Front Panels (Pair Only) - \$750.00/pr.

Hardtop/Convertible Rear Panels (Pair Only) - \$500.00/pr.

Complete 2-Door Front & Rear Panels (Pairs Only) - \$1250.00/set

Complete 4-Door Front & Rear Panels (Pairs Only) - \$1250.00/set

**NOTE* Custom refurbishing does not include the refinishing of metal trim and decorative emblems. We highly recommend this work is done before sending the panels.*

SHIPPING/HANDLING RATE CHART

<u>Order Value \$</u>	<u>Flat Rate</u>	<u>Oversize Charges</u>	<u>Rate</u>
.01-40	\$8	OS1	\$21
41-100	\$18	OS2	\$41
101-200	*\$27	OS3	\$59
201-400	*\$34	Insurance	*\$3.50
401-600	*\$39		
601-800	*\$62		
801-1000	*\$90		
1001-1250	*\$109		
1251-1500	*\$137		
1501-1850	*\$172		
1851-2100	*\$206		
2101-2500	*\$235		
2501-2999	*\$265		
3000-up	*\$293		

*Includes \$3.50 for insurance

*On all orders over \$100

*NYS Customers - Sales tax will be added

*AK, HI, PR & International customers call for shipping

*Next Day, 2nd Day & 3 Day Select shipping, please call for rates

<u>Oversize Items</u>	<u>Classification</u>
Package Tray	OS1
Trunk Divider	OS1
Plastic Door Panels	OS1
Pre-Assembled Door Panels	OS1
2nd Gen F-Body Door Panels	OS1 
Consoles	OS1
Bucket Molded Foam	OS1
Install Kits 2-5, 12-15	OS1
Vinyl Yardage (1yd & up)	OS1

<u>Oversize Items</u>	<u>Classification</u>
Molded Headliners	OS3
Molded Hood Pads	OS3
Pick Up Seat Back Kits	OS3 
GM Bench Seat Foam	OS3
E-Body Dash Pads/Caps	OS3
Trunk Packages	OS3

<u>Oversize Items</u>	<u>Classification</u>
C-Body Carpet Kits	OS2
62-65 B Body Mopar Carpet Kits	OS2
Carpet Yardage	OS2 
Sound Dampeners	OS2
Firewall Insulation	OS2
Convertible Glass	OS2

2023 TENTATIVE SHOWS AND DATES

Spring Carlisle
Chryslers @ Carlisle

Fall Carlisle
SEMA

Carlisle, PA
Carlisle, PA
Carlisle, PA
Las Vegas, NV

April 19 - 23, 2023
July 14 - 16, 2023
Sept. 27 - Oct. 1, 2023
Oct. 31 - 3, 2023

Due to the ongoing COVID-19 pandemic the above dates are tentative and are subject to being changed or cancelled. For updates please check our website at www.legendaryautointeriors.com or call us at 1-800-363-8804.

Legendary Auto Interiors Ltd. welcomes the opportunity to support the smaller clubs' and organizations' car shows and swap meets. A variety of flyers, catalogs and gift certificates are available to clubs and organizations who sponsor shows nationwide. Please call or write for additional information. The list above is a tentative schedule subject to change without notice. Come visit us at many car shows/swap meets and see what makes a Legendary interior... truly Legendary.



Legendary
AUTO INTERIORS LTD.

Table of Contents - Cutlass & 442

SEAT UPHOLSTERY & TRIM ACCESORIES H1-H19

Bench Seatback Release Knob.....	H18	Bucket Seat Spring Assembly	H18
Bucket Seat Back Panels	H19	Cotton Rolls	H19
Bucket Seat Back Release Buttons.....	H18	Headrest Covers.....	H2-H4, H6-H17
Bucket Seat Bases	H19	High Density Foam	H19
Bucket Seat Chrome Trim	H19	Hog Ring Plier Kits	H19
Bucket Seat Headrests.....	H18	Muslin	H19
Bucket Seat Headrest Lock Assembly.....	H18	Seat Adjustment Knobs	H18
Bucket Seat Headrest Mounting Kit.....	H18	Seat Back Bumpers.....	H18
Bucket Seat Hinge End Cap.....	H18	Seat Bottom Stretch Panel Boards.....	H19
Bucket Seat Mount Conversion Brackets .	H18	Seat Upholstery.....	H2-F17

MOLDED FOAM & FOAM ACCESORIES H20-H22

Molded Foam.....	H21
Seat Upholstery Installation Kits.....	H22

DOOR PANELS & TRIM ACCESORIES H23-H34

Armrest Bases	H30	Door Panel Trim Molding	H32
Armrest Base Chrome Back Plate.....	H30	Door Panel Watershields.....	H34
Armrest Base Molding	H31	Door Panel Windlace.....	H32
Armrest Base Screw Set	H31	Door Sill Plates	H34
Armrest Pads.....	H30	Door & Window Handle Plastic Washer	H33
Ashtrays.....	H31	Door & Window Handle Retaining Clip.....	H33
Armrest/Ashwell Covers	H24-H30	Hinge to Door Bolts	H31
Ashwell Installation Pad Kits.....	H31	Jute Backing	H34
Conv. Courtesy Light Lens & Bezels	H31	Lower Door Hinge Pins.....	H34
Door Handles.....	H33	Lower Door Spring.....	H34
Door Hinges.....	H34	Seat Belt Bolts	H34
Door Jamb Windlace	H32	Upper Door Jamb End Caps	H32
Door Lock Ferrules	H32	Vent Window Cranks	H33
Door Lock Knobs	H32	Vent Window Handles	H33
Door Lock Striker.....	H34	Window Crank Handles	H33
Door Panels.....	H24-H29	Window Handles Springs	H33
Door Panel Clips & Retainers.....	H32		
Door Panel Emblems.....	H34		

CARPETS, FLOORMATS & ACCESORIES H35-H44

Carpet.....	H38	Floormats.....	H43
Carpet Color Selector.....	H37	Kick Panels.....	H38
Carpeted Floormats.....	H44	Kick Panel Carpet.....	H38
Carpet Yardage	H38	Kick Panel Insulation	H38
Floormat Color Selector.....	H42	Sound Deadener	H38
		Sound Dampening.....	H38

DASHES, CONSOLES, SHIFTERS & ACCESORIES H49-H52

8-Track Faceplate.....	H50	Glovebox Liners & Emblems	H50
Dash & Console Inserts.....	H50	Pedal Pads & Bezels.....	H51
Dash Pad Emblems.....	H50	Shifter Boots.....	H52
Firewall Guard Fastener.....	H51	Shifter Boot Ornament.....	H52
Firewall Insulation.....	H51	Steering Column Covers	H52
Gas Pedal Rod Pin.....	H51	Steering Column Seal.....	H52
Gas Pedal Spring	H51	Underdash Insulation.....	H50

Table of Contents - Cutlass & 442

HEADLINERS & TRIM ACCESORIES H53-H58

Dome Light Lens & Bezels	H56	Headliner Insulation.....	H55
Convertible Sunvisor Brackets	H58	Pillar Post Moldings	H56
Courtesy Light Lens & Bezels	H56	Sail Panel Boards	H56
Headliners	H55	Sunvisors	H58
Headliner Bow Retainer Clips.....	H55	Sunvisor Supports	H58
Headliner Color Selector	H54	Sunvisor Tip & Bushing Kit	H58
		Upper Windshield Trim	H55

PACKAGE TRAY AND TRUNK ACCESORIES H59-H62

Package Tray & Jute Insulation	H60-H61
Spare Tire Cover	H62
Trunk Area Speaker Cover	H62
Trunk Divider & Jute Insulation	H62
Trunk Mats.....	H62
Trunk Mat Material.....	H62

VINYL TOPS, CONVERTIBLE TOPS & ACCESORIES H63-H68

Convertible Body Screw Studs	H68
Convertible Boots	H68
Convertible Header Panel Vinyl.....	H67
Convertible Tops.....	H65
Convertible Top Color Selector	H65
Convertible Top Guide Pin.....	H67
Convertible Top Latch Hooks.....	H67
Convertible Top Latch Hook Knuckles.....	H67
Convertible Top Motor Cover.....	H67
Convertible Top Pads	H67
Convertible Top Plastic Guide Pins	H67
Convertible Top Tension Cables	H67
Convertible Well Liners.....	H68
Vinyl Tops	H64

WEATHERSTRIPPING & ACCESORIES H69-H71

Convertible Top Frame Weatherstrip Kit....	H71
Door Lock Seals	H70
Door Weatherstripping.....	H70
Header Seals.....	H71
Hood Pads.....	H71
Hood Pad Clips.....	H71
Hood Pad Insulation	H71
Hood to Cowl Seals	H70
Pillar Post Weatherstripping	H71
Rear Quarter Window Seals.....	H70
Roof Rail Weatherstripping.....	H70
Trunk Seals	H70
Window Sweep Kits.....	H71



OVER 225 DIFFERENT INTERIOR STYLES OFFERED FOR CHRYSLER & AMC

1957-76 MOPAR A,B,C,E & F-BODY, 1963-68 DODGE A-100 VAN
1973-79 DODGE TRUCK & 1968-74 AMC JAVELIN/AMX

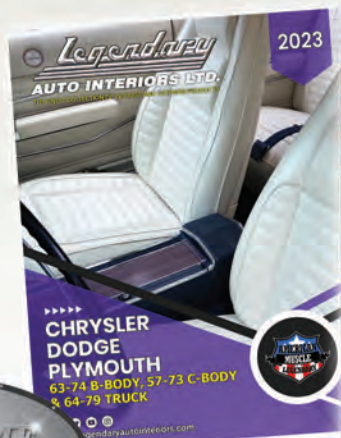

WWW.LEGENDARYAUTOINTERIORS.COM

Legendary Auto Interiors, Ltd.
121 West Shore Blvd
Newark, NY 14513



 twitter.com/legendaryautoin

 youtube.com/user/legendaryauto

 facebook.com/legendaryautointeriors

 instagram.com/legendaryautointeriorsltd

LEGENDARY AUTO INTERIORS

1-800-363-8804

WWW.LEGENDARYAUTOINTERIORS.COM