



Legendary

AUTO INTERIORS LTD.®

THE FINEST COLLECTION OF INTERIOR AND EXTERIOR PRODUCTS

2023
FIRST
QUARTER



CHRYSLER

DODGE

PLYMOUTH

63-74 B-BODY, 57-73 C-BODY
& 64-79 TRUCK



www.legendaryautointeriors.com



OVER 225 DIFFERENT INTERIOR STYLES OFFERED FOR CHRYSLER & AMC

1957-76 MOPAR A,B,C,E & F-BODY, 1963-68 DODGE A-100 VAN
1973-79 DODGE TRUCK & 1968-74 AMC JAVELIN/AMX

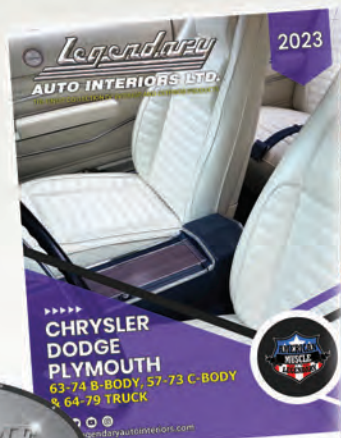

WWW.LEGENDARYAUTOINTERIORS.COM

A Special Message from the President...

For over 3 decades, Legendary Auto Interiors, Ltd has been committed to providing the automotive restoration industry and enthusiast with the world's highest quality soft trim products and services. Available from the most authentic "As Original" interiors to the most extreme "One of a Kind" Custom Resto-Mod interiors, Legendary has been relied upon and Legendary has delivered!

This past decade has been extremely exciting! We continue to set the bar and truly lead by example, establishing industry expectations and standards. Introducing innovative tools such as our exclusive "Custom Design Center", "LegendImagery™" and "Sample Request Center". Whether your preference is "As Original" or a creation of your own vision, we have created a destination where you can let your imagination lead the way! Our commitment to developing and maintaining innovative solutions is a dedicated process that will continue to provide you with great products, service and help grow our restoration industry.

We are looking forward to a very productive future. As owner and President and from all of our proud team here at Legendary Auto Interiors LTD, we would like to thank you for allowing us the opportunity and the privilege of being your automotive soft trim supplier.

Thank you once again for your business, interest and support!

Sincerely yours,



Martin J. Beckenbach
President

PRODUCT DISCLAIMER: Products listed in this catalog have been reproduced and/or remanufactured to resemble original products. All manufacturers names and descriptions are used for reference purposes only. It is therefore understood that the products listed in this catalog are in fact REPRODUCTIONS unless specified otherwise. All parts described and offered for sale in this publication as NOS (New Old Stock) are new parts/materials manufactured by or for Chrysler LLC and General Motors Corporation.

All literature produced by and directly related to Legendary Auto Interiors Ltd., is protected under copyright laws.
All literature cannot be reproduced for any reason unless prior permission is obtained.



FLEXTRREAD®

YOU ASK FOR IT...WE DELIVERED!!

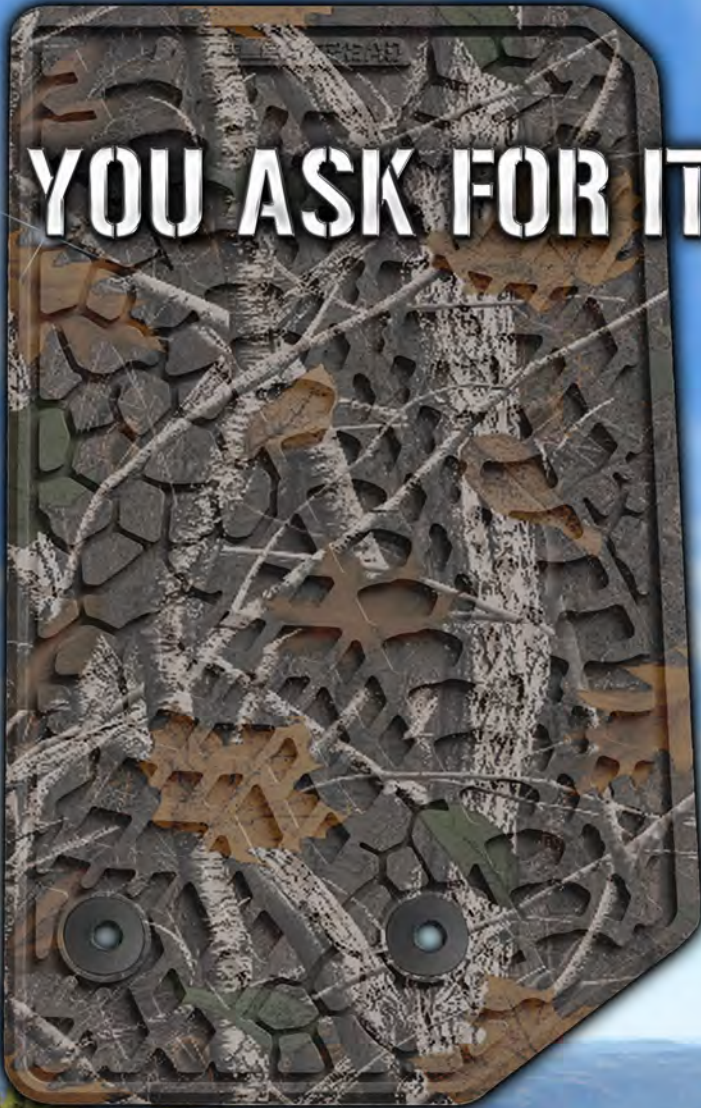

**PINK COMING
2023!**



YOU ASK FOR IT...WE DELIVERED!!

PATENTED

SCENERY MATS

VERSAFIT™ TRIM-TO-FIT MATS

**MANY KOOL SCENES AVAILABLE
AND MORE COMING SOON!**

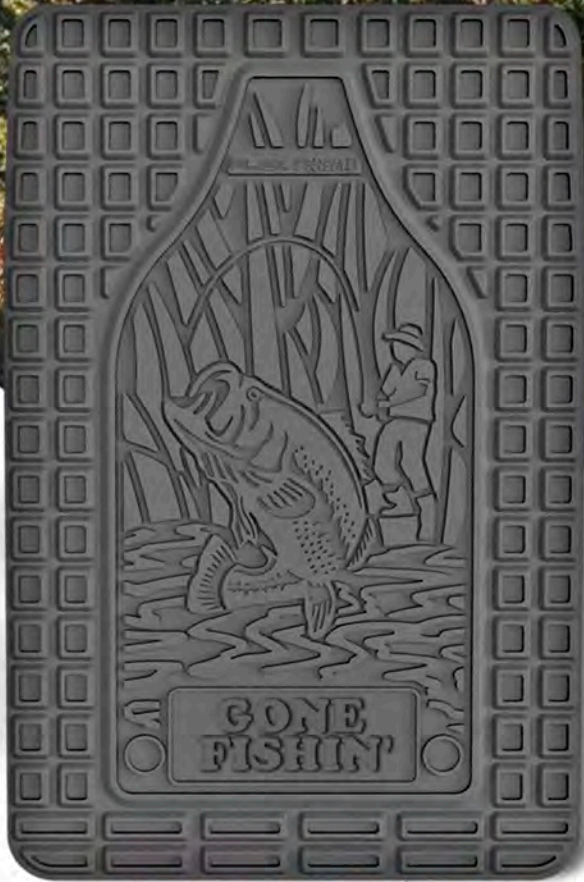

FISHING SCENE



DUCK SCENE

BOOTMATS

SCENERY AVAILABLE ON VERSAFIT™ & BOOTMATS



WHITETAIL SCENE



EQUINE SCENE



**SCORCHED EARTH &
TIRE TRACK SCENE**

Versafit™

Trim-To-Fit Mats

CHOOSE
YOUR
SCENE

VERSAFIT™ universal trim-to-fit floor mats fit most domestic and foreign vehicles. Mats can be cut to fit your vehicle's unique floorpan. Includes manual screw in style safety retention positioning posts for installation.



Bootmats

CHOOSE
YOUR
SCENE

"Fun"ctional Boot Mats from FLEXTREAD bring a KOOL look inside while leaving the mess at the door. Featuring scenery and measuring finished size 16" tall by 28" wide.



FLOORMAT & BOOTMAT COLORS



001 - Black

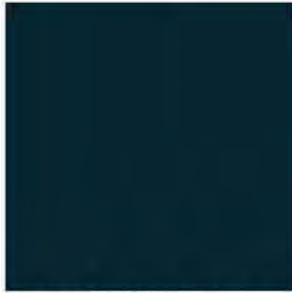

007 - Dark Blue



011 - Medium Blue



018 - Bright Red



020 - Red



023 - Tan



031 - Maroon



050 - Turquoise



057 - Dark Olive Green



074 - Pink



079 - Grey



098 - Brown



129 - Dark Saddle



132 - Gold

CAMOUFLAGE



200 - Rugged Woods



202 - Cyberflage



201 - Rugged Woods "Pink"



203 - Cyberflage "Pink"

FLEXTREAD LLC
1-833-700-3539 EXT. 222
WWW.FLEXTREADMATS.COM



INTRODUCING THE BEST WARRANTY COVERAGE IN THE INDUSTRY!!

Limited Lifetime Warranty

Limited Warranty - Legendary Auto Interiors Ltd. (called "we") warrants that the products it manufactures will be free of defects in materials and workmanship from the date it is first purchased by the retail purchaser. A retail purchaser is any person or any entity who or which purchases the product but does not do so for resale.

Obligation - If a product is not as warranted, we will either repair or, at our option, replace the defective product. If repair or replacement is not possible within a reasonable time, we will refund the purchase price.

Exclusions from Warranty - This Warranty does not apply to:

1. Conditions resulting from the product being altered, abused, misused, damaged by accident or negligence; being repaired without our authorization; or not being maintained properly in accordance with written instructions provided with the product.
2. Conditions resulting from ordinary wear and tear or including, without limitation, exposure to ultraviolet light.
3. Conditions resulting from the use of Specialty Run Materials (SRM) supplied by the purchaser.
4. Conditions resulting from improper installation by the purchaser or anyone else outside of our control.

Disclaimer - EXCEPT FOR THE LIMITED WARRANTY DESCRIBED ABOVE, WE OFFER NO WARRANTIES, EXPRESSED OR IMPLIED, AND OTHER THAN THE LIMITED WARRANTY EXPRESSLY CONTAINED HEREIN, WE HEREBY DISCLAIM ANY AND ALL WARRANTIES, INCLUDING WITHOUT LIMITATION ANY IMPLIED WARRANTIES OF MERCHANTABILITY, SUITABILITY OR FITNESS FOR A PARTICULAR PURPOSE. Some states do not allow limitations on how long an implied warranty lasts, so the above limitation may not apply to you.

Exclusion of Incidental and Consequential Damages - WE ARE NOT RESPONSIBLE FOR ANY INCIDENTAL OR CONSEQUENTIAL DAMAGES RESULTING FROM BREACH OF THE LIMITED WARRANTY DESCRIBED ABOVE. Some states do not allow the exclusion or limitation of incidental or consequential damages, so the above limitation or exclusion may not apply to you.

Other Legal Rights - This Warranty gives you specific legal rights, and you may also have other rights which vary from state to state.

What To Do If You Have A Warranty Claim - If you have a warranty claim, you must call our sales office for further assistance. Once given a return authorization number please indicate the number on the box and return the product to our facility; Legendary Auto Interiors 121 West Shore Blvd, Newark, NY 14513. We will perform our warranty obligation within a reasonable amount of time after the returned product arrives at our facility.













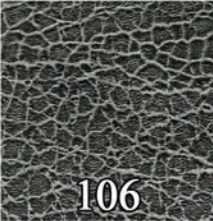





















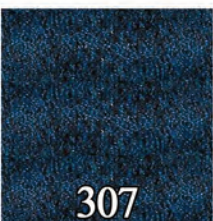







PRODUCT DISCLAIMER: Products listed in this catalog have been reproduced and/or remanufactured to resemble original products. All manufacturers names and descriptions are used for reference purposes only. It is therefore understood that the products listed in this catalog are in fact REPRODUCTIONS unless specified otherwise. All parts described and offered for sale in this publication as NOS (New Old Stock) are new parts/materials manufactured by or for Chrysler Group LLC and General Motors Corporation.

LEGENDARY AUTO INTERIORS LTD., COPYRIGHT 2022

All literature produced by and directly related to Legendary Auto Interiors Ltd., is protected under copyright laws. All literature cannot be reproduced for any reason unless prior permission is obtained.

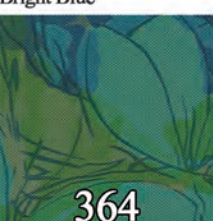
Vinyl Color Chart

 100 Black	 102 Silver	 104 Silver	 106 Silver Cast Black	 110 Dark Gray	 112 Dark Gray	 125 Dark Gray
 130 Pewter	 134 Platinum	 140 Metallic Gunmetal	 154 Metallic Charcoal	 156 Charcoal	 200 White	 202 Pearl White
 204 Dark White	 206 Taupe	 209 Taupe	 210 Opal	 220 Oyster	 230 68 Metallic Parchment	 250 Parchment
 252 Metallic Parchment	 264 Parchment	 266 Metallic Parchment	 302 Blue	 304 Light Blue	 306 Blue	 307 Blue
 308 Dark Metallic Blue	 310 Lt. Met. Powder Blue	 313 Met. Navy/ Black Filled	 314 Metallic Blue	 318 Lt. Metallic Blue	 320 Metallic Navy	 322 Medium Metallic Blue
 330 Dark Met. Blue	 331 Powder Blue	 332 Lt. Metallic Blue	 333 Dark Blue	 336 Navy Blue	 338 Bright Blue	 340 Bright Blue
 341 Bright Blue	 342 Dark Blue	 344 Dark Metallic Blue	 347 Lt. Metallic Blue	 360 Lagoon Blue	 364 Blue Green MOD	 406 Light Turquoise



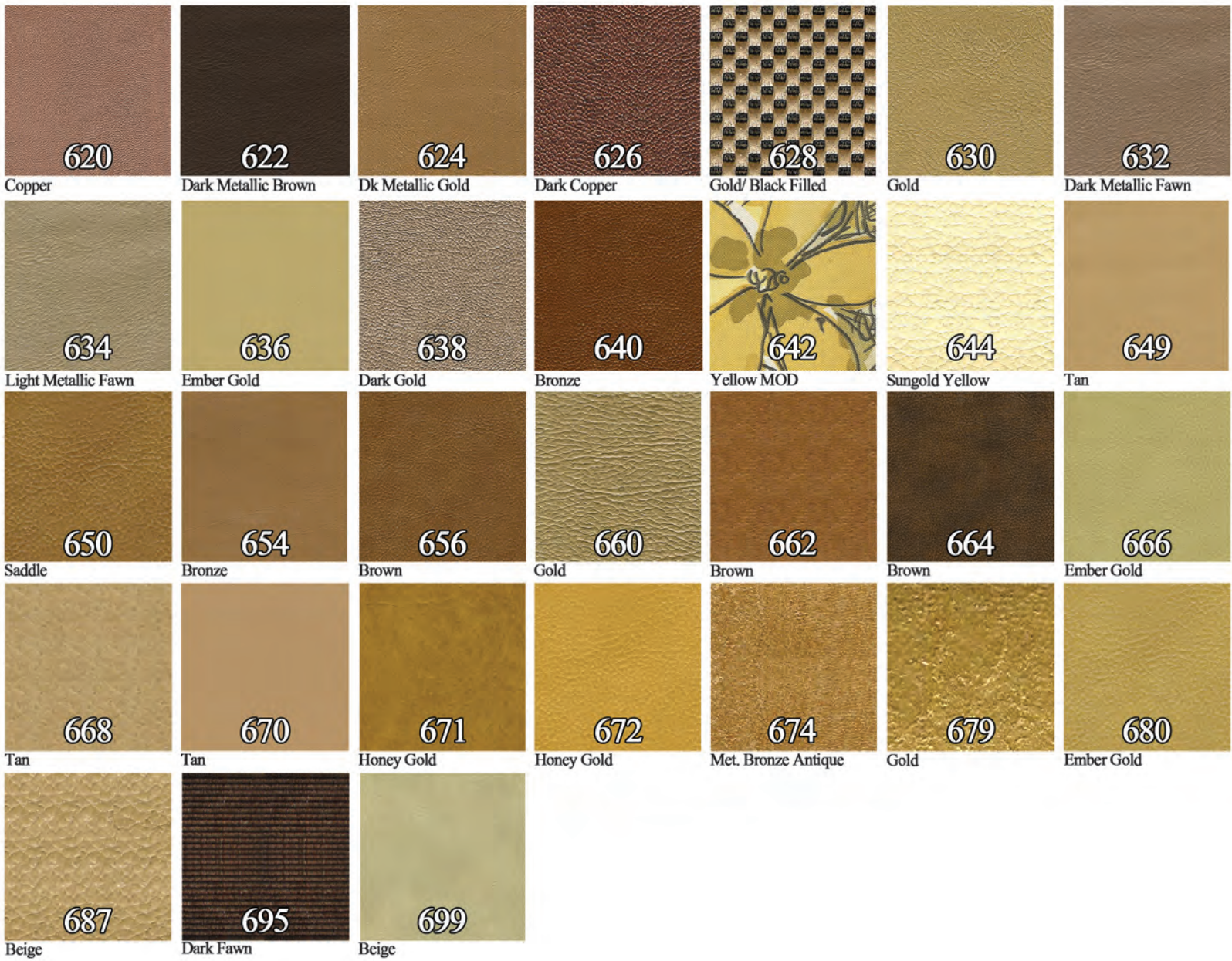

Cloth Color Chart



380

Savoy Cloth Blue



580

Savoy Cloth Red



688

Champagne Cloth



691

NOS Fawn Cloth



700

65 Belvedere II Cloth Blue



702

65 Belvedere II Cloth Tan

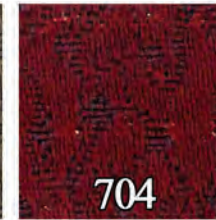

704

65 Belvedere II Cloth Red



706

65 Belvedere II Cloth Turquoise

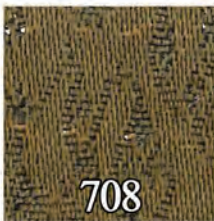

708

65 Belvedere II Cloth Gold



712

66 Belvedere I Cloth Dark Blue



714

66 Belvedere I Cloth Gold



716

66 Belvedere I Cloth Red



720

66 Belvedere II Cloth Dark Blue



722

66 Belvedere II Cloth Turquoise



724

66 Belvedere II Cloth Gold



726

66 Belvedere II Cloth Dark Green



728

66 Belvedere II Cloth Red



740

67 Belvedere II Cloth Black



742

67 Belvedere II Cloth Dark Blue



744

67 Belvedere II Cloth Turquoise



746

67 Belvedere II Cloth Brown



748

67 Belvedere II Cloth Gold



760

67 NOS Cloth Blue



762

67 Fury I Cloth Turquoise



764

67 Fury I Cloth Gold



770

70 Satellite Cloth Black



772

70 Satellite Cloth Blue



776

70 Satellite Cloth Dark Green



778

70 Satellite Hardtop Cloth Gold



790

Houndstooth Cloth Black & White



792

Houndstooth Cloth Black & Burnt Orange



801

Hang Ten Multicolor Stripe NOS Vinyl

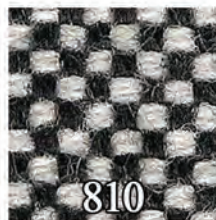

810

Salt & Pepper Cloth Black & White



812

Salt & Pepper Cloth Black & Charcoal



814

Salt & Pepper Cloth Black & Orange



818

Salt & Pepper Cloth Black & Blue



820

Salt & Pepper Cloth Black & Green



830

Plaid Cloth Black & White



832

Plaid Cloth Green

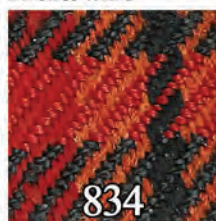

834

Plaid Cloth Black & Orange



836

Plaid Cloth Blue



837

Plaid Cloth Yellow & Green



840

71 Charger/ Sport Fury Ribbed Cloth Black

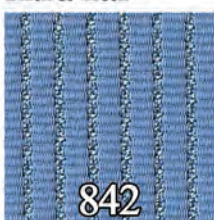

842

71 Charger/ Sport Fury Ribbed Cloth Blue



844

71 Charger/ Sport Fury Ribbed Cloth Green



846

71 Charger/ Sport Fury Ribbed Cloth Ember



854

68 Satellite Cloth Light Green



858

68 Satellite Cloth Dark Blue



860

68 Satellite Cloth Gold



68 Satellite Cloth Black



66 Coronet Cloth Blue

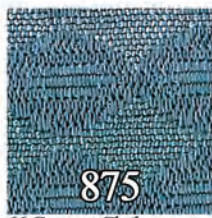

66 Coronet Cloth Turquoise



66 Coronet Cloth Gold



72 Diamond Cloth Black & White



72 Diamond Cloth Black & White

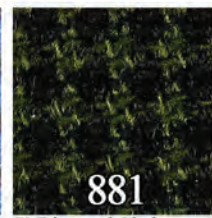

72 Diamond Cloth Black & Green



69 Satellite Cloth Black



69 Satellite Cloth Green

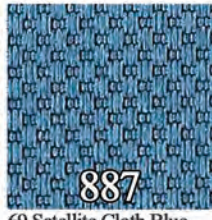

69 Satellite Cloth Blue



69 Satellite Cloth Gold



70 Newport/300 Tan Cloth



Black Cloth

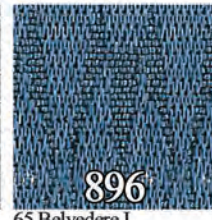

65 Belvedere I Blue Cloth



65 Belvedere I Red Cloth



65 Belvedere I Fawn Cloth



64 Fury Blue Cloth



64 Fury Fawn Cloth



64 Fury Turquoise Cloth



64 Fury Red Cloth



64 Fury Copper Cloth

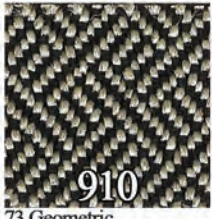

73 Geometric Parchment Cloth



74 Black Cloth



74 Parchment Cloth



74 Green Cloth



74 Blue Cloth



75 Black Cloth

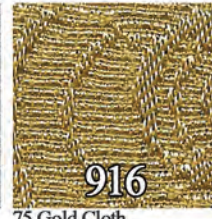

75 Gold Cloth



75 Green Cloth



75 Parchment Cloth



73/74 Charger Black Cloth



73 Charger Dark Green Cloth



74 Charger Jade Green Cloth



73 Charger Brite Blue Cloth



74 Charger Lagoon Blue Cloth



73 Charger Honey Gold Cloth

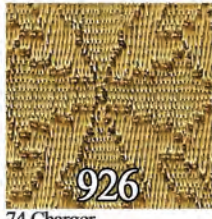

74 Charger Ember Gold Cloth



Black Cloth



Navy Cloth



Red/Black/White Wimbledon Cloth

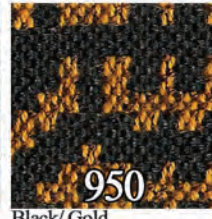

Black/Gold Aztec Cloth



White/Black Geometric Cloth



NOS Dark Blue Geometric Cloth



Brite Blue/Black Geometric Cloth



Dark Metallic Green/Black Geometric Cloth

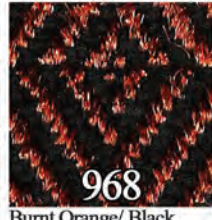

Burnt Orange/Black Geometric Cloth



Gold/Black Geometric Cloth



Blue Stripe Cloth

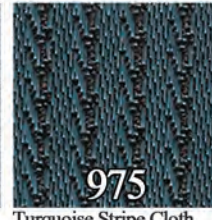

Turquoise Stripe Cloth



Red Stripe Cloth



Brown Stripe Cloth



Black Stripe Cloth

Vinyl Grain Chart

Grain	Grain	Grain	Grain
Ascot Grain	Bambino Grain	Bedford Grain	Belmont Grain
Bison Grain	Boar Grain	Chrysler Basketweave	Cirrus Grain
Coachman Grain	Cologne Grain	Crater Grain	Crush Grain
Dakota Grain	Derma Grain	Diamond Basketweave	Diamond Waffle Grain
Dorchester	Double Stitch Rib	El Paso	Empire

Vinyl Grain Chart

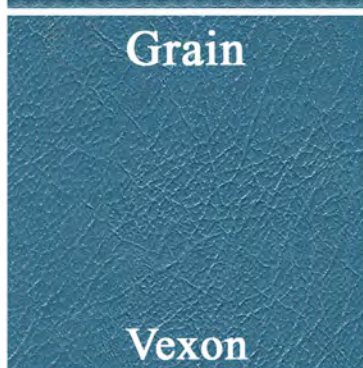
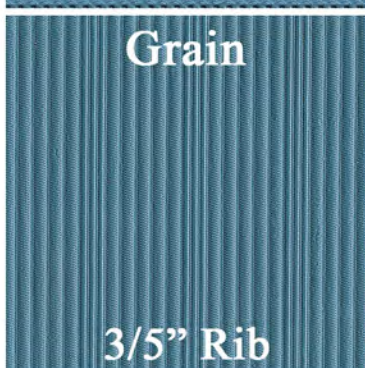
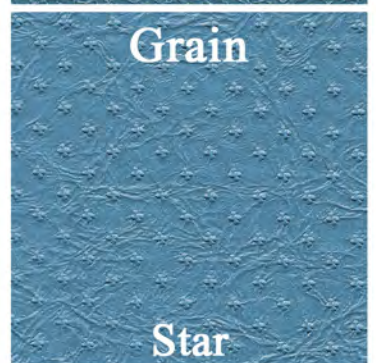
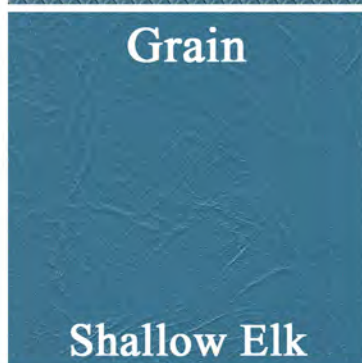
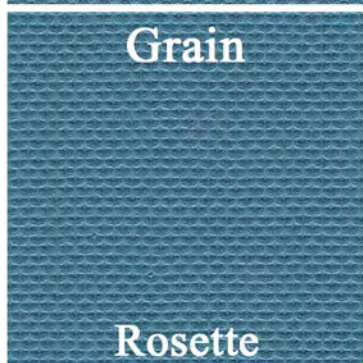
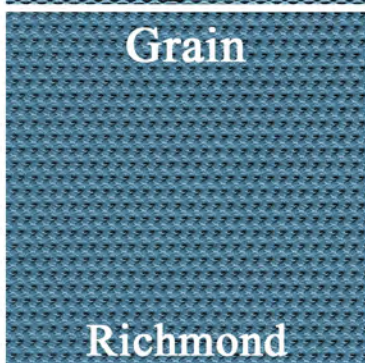
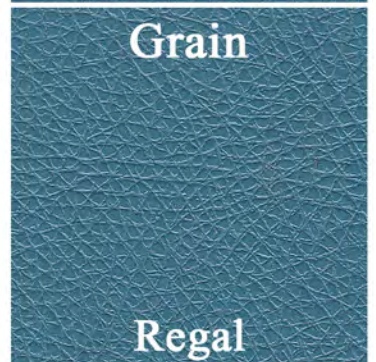
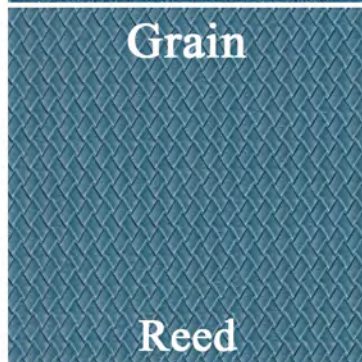
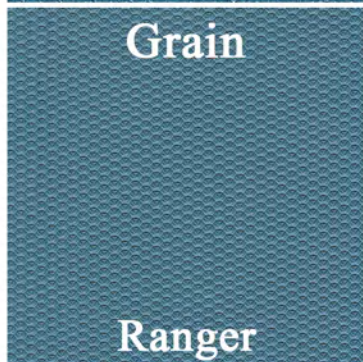
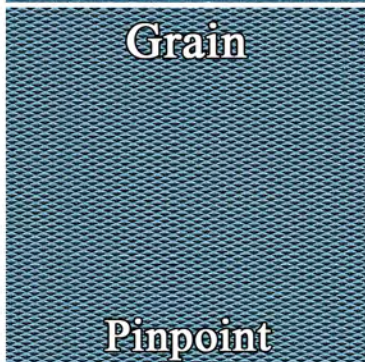
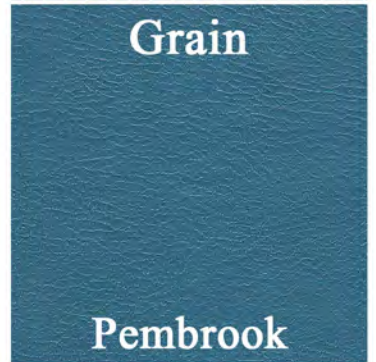
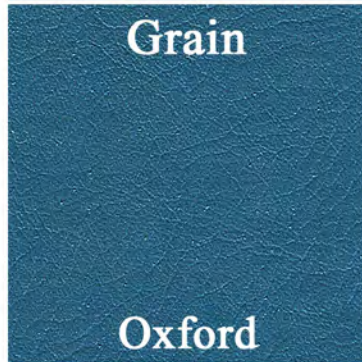
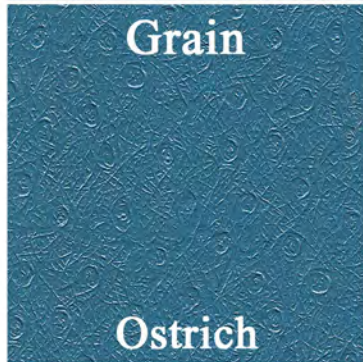
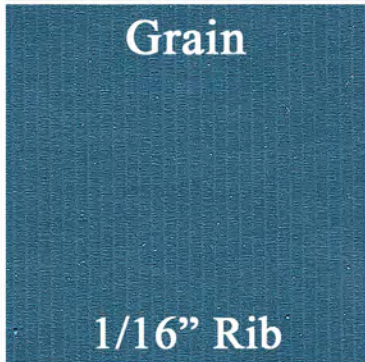
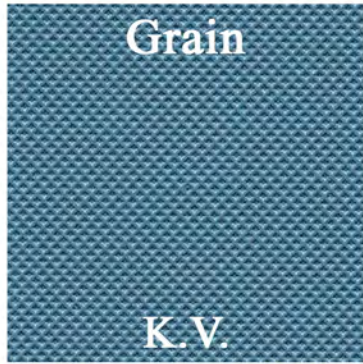
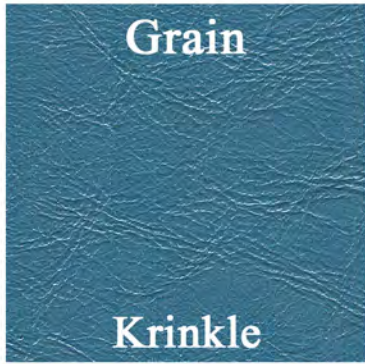



Vinyl Yardage

The following grains are available off the roll and come in 1/2 yard increments ONLY

Ascot
 VVYDASCOT(C) (1 Yard).....\$64.00/yd. 
 VV1/2YDASCOT(C) (1/2 Yard).....\$32.00/ea.
 Available colors: 100

Bison
 VVYDBISON(C) (1 Yard).....\$64.00/yd. 
 VV1/2YDBISON(C) (1/2 Yard).....\$32.00/ea.
 Available colors: 100, 204, 314, 510, 606, 610

Coachman
 VVYDCOACHMAN(C) (1 Yard).....\$64.00/yd. 
 VV1/2YDCOACHMAN(C) (1/2 Yard).....\$32.00/ea.
 Available colors: 100, 130, 140, 200, 330, 338, 340, 432, 434, 452, 528, 540, 550, 560, 640, 650, 656, 664, 666, 670

Cologne
 VVYDCOLOGNE(C) (1 Yard).....\$64.00/yd. 
 VV1/2YDCOLOGNE(C) (1/2 Yard).....\$32.00/ea.
 Available colors: 100, 102, 10A, 202, 318, 320, 332, 414, 420, 430, 520, 526, 614, 620, 636

Doeskin
 VVYDDOESKIN(C) (1 Yard).....\$64.00/yd. 
 VV1/2YDDOESKIN(C) (1/2 Yard).....\$32.00/ea.
 Available colors: 100, 104, 200, 206G, 508G

Dorchester
 VVYDDORCHESTER(C) (1 Yard).....\$64.00/yd. 
 VV1/2YDDORCHESTER(C) (1/2 Yard).....\$32.00/ea.
 Available colors: 100, 202

El Paso
 VVYDELPASO(C) (1 Yard).....\$64.00/yd. 
 VV1/2YDELPASO(C) (1/2 Yard).....\$32.00/ea.
 Available colors: 100, 200

Krinkle
 VVYDKRINKLE(C) (1 Yard).....\$64.00/yd. 
 VV1/2YDKRINKLE(C) (1/2 Yard).....\$32.00/ea.
 Available colors: 100, 154

Madrid
 VVYDMADRID(C) (1 Yard).....\$64.00/yd. 
 VV1/2YDMADRID(C) (1/2 Yard).....\$32.00/ea.
 Available colors: 100G, 202G, 204G, 210G, 220G, 230G, 235G, 239G, 240G, 310G, 325G, 331G, 333G, 334G, 338G, 342G, 343G, 351G, 369G, 380G, 415G, 420G, 421G, 424G, 429G, 448G, 460G, 465G, 469G, 501G, 511G, 513G, 520G, 631G, 635G, 640G, 642G, 645G, 650G, 651G, 657G, 658G, 670G, 679G, 683G, 690G, 694G, 695G, 697G, 709G, 710G

Oxen
 VVYDOXEN(C) (1 Yard).....\$64.00/yd. 
 VV1/2YDOXEN(C) (1/2 Yard).....\$32.00/ea.
 Available colors: 100

Oxford
 VVYDOXFORD(C) (1 Yard).....\$64.00/yd. 
 VV1/2YDOXFORD(C) (1/2 Yard).....\$32.00/ea.
 Available colors: 100, 200, 264, 360, 450

Ranger
 VVYDRANGER(C) (1 Yard).....\$64.00/yd. 
 VV1/2YDRANGER(C) (1/2 Yard).....\$32.00/ea.
 Available colors: 100, 200

Shallow Elk
 VVYDSHALLOWELK(C) (1 Yard).....\$64.00/yd. 
 VV1/2YDSHALLOWELK(C) (1/2 Yard).....\$32.00/ea.
 Available colors: 100, 156, 200, 202G, 230G, 341

Sierra
 VVYDSIERRA(C) (1 Yard).....\$64.00/yd. 
 VV1/2YDSIERRA(C) (1/2 Yard).....\$32.00/ea.
 Available colors: 100G, 102G, 200G, 209G, 319G, 528G, 684G, 688G

1 YARD AND MORE IS SHIPPED OVERSIZED 1

Specialty Grain Vinyl Yardage



All grain/color combinations not listed above can be produced upon request.
 Available in 1/2 yd or 1yd sheets ONLY



1/2 Yard (54"x18")
 TTMOLDSMALL.....\$36.00/ea.
 * Need to specify grain and color

1 Yard (54"x36")
 TTMOLDXL.....\$96.00/ea. 
 * Need to specify grain and color



UPHOLSTERY AND TRIM ACCESORIES

 facebook.com/legendaryautointeriors
 twitter.com/legendaryautoin

 www.legendaryautointeriors.com
 instagram.com/legendaryautointeriorsltd
 youtube.com/user/legendaryauto

1965 SATELLITE

This Legendary product features as-original heat sealed Bison grain inserts with Bison grain skirts.

(C) COLOR CODES:

- (101) - Black (100) with Silver Tinsel welt [Trim Code P4X]
- (301) - Dark Blue (322) / Light Blue (314) with Silver Tinsel welt [Trim Code P4B]
- (315) - Dark Blue (322) / Light Blue (314) [Trim Code P4B]
- (415) - Dark Turquoise (414) / Light Turquoise (416) [Trim Code P4Q]
- (421) - Dark Turquoise (414) / Light Turquoise (416) with Silver Tinsel welt [Trim Code P4Q]
- (521) - Maroon (526) / Crimson Red (510) [Trim Code P4R]
- (531) - Maroon (526) / Crimson Red (510) with Silver Tinsel welt [Trim Code P4R]
- (625) - Dark Gold (624) / Light Gold (614) [Trim Code P4Y]
- (681) - Dark Gold (624) / Light Gold (614) with Silver Tinsel [Trim Code P4Y]

(C) SEATBACK PANEL COLOR CODES:

- (298) - Light Blue (314) / Dark Blue (322)
- (405) - Light Turquoise (414) / Dark Turquoise (416)
- (522) - Crimson Red (510) / Maroon (526)
- (698) - Light Gold (614) / Dark Gold (624)

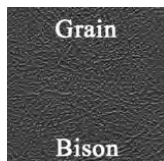

- Front Buckets **AA65CR00010(C)**
- 101, 301, 315, 415, 421, 521, 531..... \$690/pr.
- 625, 681..... \$992/pr. (L4)
- *Please specify silver tinsel or color of vinyl cordwelt around seat inserts at time of order.*
- *Please specify carpet color of stretch panel at time of order.*
- *Molded foam is available for this model. Please see the "Molded Foam" section in this catalog.*
- Front Bucket Seatback Panels **SK65CR00018(C)**
- (Pre-sewn vinyl panels with new boards)
- 100, 298, 405, 522..... \$184/pr.
- 698..... \$279/pr. (L1)
- Hardtop Rear Bench..... **AA65CR00040(C)**
- Convertible Rear Bench **AA65CR00050(C)**
- 101, 301, 315, 415, 421, 521, 531 \$641/ea.
- 625, 681..... \$945/ea. (L4)
- Convertible Rear Bench Back Panel **SK65CR00019(C)**
- 100, 314, 416, 510, 614..... \$75/ea.

1966 SATELLITE

This Legendary product features as-original heat sealed Cologne grain inserts with Western Scroll strips & Cologne grain skirts.

(C) COLOR CODES:

- (100) - Black [Trim Code P4X]
- (318) - Blue [Trim Code P4B]
- (420) - Citron [Trim Code P4Y]
- (520) - Red [Trim Code P4R]
- (614) - Gold [Trim Code P4T]

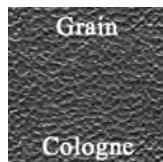

- Front Buckets **AA66CR00010(C)**
- (All colors)..... \$641/pr.
- *Molded foam is available for this model. See the "Molded Foam" section in this catalog.*
- Fold-Down Center Cushion/Armrest..... **CR66CRWX013(C)**
- (All colors)..... \$99/ea.
- Hardtop Rear Bench..... **AA66CR00040(C)**
- Convertible Rear Bench **AA66CR00050(C)**
- (All colors)..... \$613/ea.
- Convertible Rear Seat Bottom Panels..... **SK66CRW0012(C)**
- (Pre-cut / pre-sewn carpeted lower trim panels)
- (All colors)..... \$75/ea.
- *Please refer to carpet color selection at time of order.*

1967 SATELLITE & GTX

This Legendary product features as-original heat sealed Cologne grain inserts with Western Scroll center strip & Cologne grain skirts.

(C) COLOR CODES:

- (100) - Black [Trim Code P6X]
- (202) - Pearl White [Trim Code P6W, P6V]
- *P6W - Pearl White w/ Black Carpet*
- *P6V - Pearl White w/ Red Carpet*
- (320) - Navy [Trim Code P6B]
- (520) - Red [Trim Code P6R]
- (620) - Copper [Trim Code P6K]

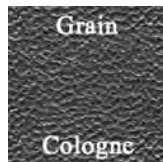

- Front Buckets **AA67CR00010(C)**
- (All colors)..... \$578/pr.
- *Molded foam is available for this model. Please see the "Molded Foam" section in this catalog.*
- Fold-Down Center Cushion/Armrest..... **CR66CRWX013(C)**
- (All colors)..... \$99/ea.
- Hardtop Rear Bench..... **AA67CR00040(C)**
- Convertible Rear Bench **AA67CR00050(C)**
- (All colors)..... \$558/ea.
- Convertible Rear Seat Bottom Panels..... **SK66CRW0012(C)**
- (Pre-cut / pre-sewn carpeted lower trim panels)
- (All colors)..... \$75/ea.
- *Refer to carpet color selection at time of order.*



1968 SPORT SATELLITE & GTX

This Legendary product features as-original
Crush grain inserts with Cologne grain skirts.

Front Buckets AA68CR00010(C)
(All colors)..... \$647/pr.
*Molded foam is available for this model.

Front Bucket Seatback Panels SK68AB00018(C)
(New boards wrapped in vinyl with mounting hardware attached
as original. Ready to install.)
100, 202, 332, 430, 526, 630..... \$167/pr.

Center Cushion/Armrest
(with map pocket) CR68CR00013(C)
(without map pocket)..... CR68CR0013(C)N
100, 202, 332, 430, 526, 630..... \$99/ea.

Hardtop Rear Bench..... AA68CR00040(C)
Convertible Rear Bench AA68CR00050(C)
(All colors)..... \$448/ea.

*Rear seat medallion not included.



(C) COLOR CODES:

- (100) - Black [Trim Code P6X, S6X]
 - (122) - Gold (630) & Black (100) / Gold (630) [Trim Code P6N, S6N]
 - (202) - Pearl White [Trim Code P6C, P6D, P6V, S6C, S6D, S6V]
 - *P6C, S6C - Pearl White w/ Blue Carpet
 - *P6D, S6D - Pearl White w/ Green Carpet
 - *P6V, S6V - Pearl White w/ Red Carpet
 - (332) - Blue [Trim Code P6B, S6B]
 - (433) - Light Green (432) / Dark Green (430) [Trim Code P6F, S6F]
 - (526) - Maroon [Trim Code P6R, S6R]
- ***Sport Satellite Trim Codes - P6X, P6N, P6C, P6D, P6V, P6B, P6F, P6R
***GTX Trim Codes - S6X, S6N, S6C, S6D, S6V, S6B, S6F, S6R

1968 SPORT SATELLITE & GTX "RALLYE SEAT"

This Legendary product features as-original
Crush grain inserts with Cologne grain skirts.

(C) COLOR CODES:

- (100) - Black
- (122) - Gold (630) & Black (100) / Gold (630)
- (202) - Pearl White
- (332) - Blue
- (433) - Light Green (432) / Dark Green (430)
- (526) - Maroon



PHOTO N/A
AT TIME OF
PRINTING

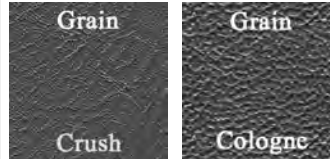

Front Buckets RS68CR00010(C) 
(All colors)..... \$1046/pr.

*Kit consists of: (1) pair Rallye Bucket Seat Upholstery, (1) set Rallye Bucket Seat Foam, (4) Front Seat Top Spring to Frame Hold Back Listing, (1 yd) Muslin, (30 ft.) Listing Wire, (2 yds) Burlap, (9 ft) 2 inch Felt and (1) Dust Mask.

Front Bucket Seatback Panels SK68AB00018(C)
(New boards wrapped in vinyl with mounting hardware attached
as original. Ready to install.)
100, 202, 332, 430, 526, 630..... \$167/pr.

Center Cushion/Armrest
(with map pocket) CR68CR00013(C)
(without map pocket)..... CR68CR0013(C)N
100, 202, 332, 430, 526, 630..... \$99/ea.

Hardtop Rear Bench..... AA68CR00040(C)
Convertible Rear Bench AA68CR00050(C)
(All colors)..... \$448/ea.
*Rear seat medallion not included.

1969 SPORT SATELLITE, GTX & ROADRUNNER

This Legendary product features as-original
El Paso grain inserts with Coachman grain skirts.

Front Buckets AA69CR00010(C)
(All colors)..... \$547/pr.
*Molded foam is available for this model.

Front Bucket Seatback Panels SK69AB00018(C)
(New boards wrapped in vinyl with mounting hardware attached
as original. Ready to install.)
(All colors)..... \$167/pr.

Center Cushion/Armrest
(with map pocket) CR69CRWX013(C)
(without map pocket) CR69CRWX13(C)N
(All colors)..... \$99/ea.

Hardtop Rear Bench..... AA69CR00040(C)
Convertible Rear Bench AA69CR00050(C)
(All colors)..... \$375/ea.
*Rear seat metal emblem not included.

(C) COLOR CODES:

- (100) - Black [Trim Code P6X]
- (130) - Pewter [Trim Code P6S]
- (200) - White [Trim Code P6W, P6C, P6H, P6F, P6V]
- *P6W - White w/ Black Carpet
- *P6C - White w/ Blue Carpet
- *P6H - White w/ Tan Carpet
- *P6F - White w/ Green Carpet
- *P6V - White w/ Red Carpet
- (330) - Dark Blue [Trim Code P6D]
- (434) - Dark Green [Trim Code P6R]
- (528) - Red [Trim Code P6R]
- (650) - Saddle [Trim Code P6T]

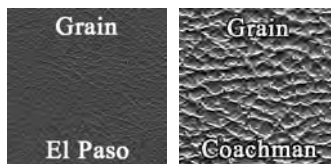



1969 SPORT SATELLITE, GTX & ROADRUNNER "RALLYE SEAT"

This Legendary product features as-original
El Paso grain inserts with Coachman grain skirts.

(C) COLOR CODES:

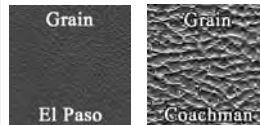
- (100) - Black
- (130) - Pewter
- (200) - White
- (330) - Dark Blue
- (434) - Dark Green
- (528) - Red
- (650) - Saddle



Front Buckets RS69CR00010(C) 
(All colors)..... \$925/pr.

*Kit consists of: (1) pair Rallye Bucket Seat Upholstery, (1) set Rallye Bucket Seat Foam, (4) Front Seat Top Spring to Frame Hold Back Listing, (1 yd) Muslin, (30 ft.) Listing Wire, (2 yds) Burlap, (9 ft) 2 inch Felt and (1) Dust Mask.

Front Bucket Seatback Panels SK69AB00018(C)
(New boards wrapped in vinyl with mounting hardware attached as original. Ready to install.)
(All colors)..... \$167/pr.

Center Cushion/Armrest
(with map pocket) CR69CRWX013(C)
(without map pocket) CR69CRWX13(C)N
(All colors)..... \$99/ea.

Hardtop Rear Bench..... AA69CR00040(C)
Convertible Rear Bench AA69CR00050(C)
(All colors)..... \$375/ea.
*Rear seat metal emblem not included.

1970 SPORT SATELLITE, GTX, ROADRUNNER & SUPERBIRD

This Legendary product features as-original Ranger grain inserts with Coachman grain skirts with heat sealed Plymouth emblem on center of rear seat.

(C) COLOR CODES:

- (100) - Black with Black welt [Not a factory option]
*Black was not originally offered, but may be purchased as a special order. Available only as a prepaid, non-refundable and non-returnable order.
- (115) - Black (100) / Black (100) with Silver welt [Not a factory option]
*Black was not originally offered, but may be purchased as a special order. Available only as a prepaid, non-refundable and non-returnable order.
- (159) - Black (100) / Charcoal (154) with Silver welt [Trim Code P6XA]
- (200) - White with White welt [Trim Codes P6XW, P6BW, P6KW]
*P6XW - White w/ Black Carpet
*P6BW - White w/ Blue Carpet
*P6KW - White w/ Burnt Orange Carpet
- (363) - Bright Blue (338) with White welt [Trim Code P6B5]
- (439) - Dark Green (434) with Light Green welt [Trim Code P6F8]
- (543) - Dark Orange (542) / Burnt Orange (540) w/ Bright Orange welt [Trim Code P6K4]
- (659) - Dark Brown (664) / Brown (656) with Dark Brown welt [Trim Code P6T5]
- (669) - Gold (660) / Gold (660) with Black welt [Trim Code P6XY]

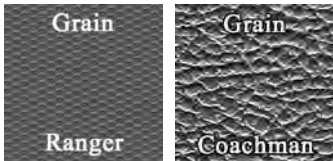

Heat-sealed Plymouth emblem



- Front Buckets **AA70CR00010(C)**
100, 115, 159, 200, 363, 439, 543, 659 \$569/pr.
669 \$1305/pr. (L1)
*Molded foam is available for this model. Please see the "Molded Foam" section in this catalog.
- Center Cushion/Armrest (with map pocket) **CR69CRWX013(C)**
Center Cushion/Armrest (without map pocket) **CR69CRWX13(C)N**
100, 154, 200, 434, 338, 540, 656 \$99/ea.
660 \$238/ea. (L1)
- Hardtop Rear Bench **AA70CR00040(C)**
Convertible Rear Bench **AA70CR00050(C)**
100, 115, 159, 200, 363, 439, 543, 659 \$478/ea.
669 \$1101/ea. (L1)

1971 SATELLITE SEBRING PLUS, ROADRUNNER & GTX "CLOTH STYLE"

This Legendary product features as-original Salt & Pepper cloth inserts with Coachman grain skirts.

(C) COLOR CODES:

- (811) - Black & White Salt & Pepper Cloth (810) / Black (100) [Trim Codes P5X9, M5X9]
***Satellite Sebring Plus & GTX Trim Code - P5X9
***Roadrunner Trim Code - M5X9



- Front Buckets **AA71CRXC010(C)**
811 \$1268/pr. (L4)
*Molded foam is available for this model. Please see the "Molded Foam" section in this catalog.
- Center Cushion/Armrest **CR71CRWXH13(C)**
100 \$99/ea.
- Rear Bench **AA71CRXC040(C)**
811 \$1118/ea. (L4)

1971 SATELLITE SEBRING PLUS, ROADRUNNER & GTX

This Legendary product features as-original El Paso grain inserts with Coachman grain skirts.

- Front Buckets **AA71CRX0010(C)**
(All colors) \$547/pr.
*Molded foam is available for this model.
- Center Cushion/Armrest **CR71CRWXH13(C)**
(All colors) \$99/ea.
- Rear Bench **AA71CRX0040(C)**
(All colors) \$450/ea.

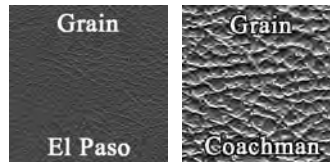

(C) COLOR CODES:

- (100) - Black [Trim Codes P6X9, M6X9]
- (140) - Gunmetal [Trim Codes P6XA, M6XA]
- (200) - White [Trim Codes P6XW, M6XW]
- (340) - Bright Blue [Trim Codes P6B5, M6B5]
- (452) - Dark Green [Trim Codes P6F7, M6F7]
- (561) - Bright Orange (560) / Black (100) [Trim Code M6XV]
- (664) - Brown [Trim Codes P6T7, M6T7]
- (666) - Ember Gold [Trim Codes P6Y3, M6Y3]
- ***Satellite Sebring Plus & GTX Trim Codes - P6X9, P6XA, P6XW, P6B5, P6F7, P6T7, P6Y3
***Roadrunner Trim Codes - M6X9, M6XA, M6XW, M6B5, M6F7, M6XV, M6T7, M6Y3



1972 SATELLITE SEBRING PLUS, ROADRUNNER & GTX

This Legendary product features as-original Shallow Elk grain inserts with Coachman grain skirts.

Front BucketsAA72CR00010(C)
 (All colors).....\$547/pr.
 *Molded foam is available for this model.

Center Cushion/Armrest.....CR71CRWXH13(C)
 (All colors).....\$99/ea.

Rear Bench.....AA72CR00040(C)
 (All colors).....\$450/ea.

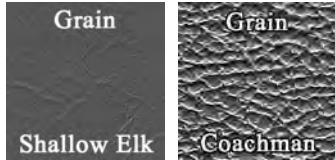

(C) COLOR CODES:

- (100) - Black [Trim Codes H6X9, D6X9]
 - (200) - White [Trim Codes H6XW, D6XW]
 - (340) - Bright Blue [Trim Codes H6B5, D6B5]
 - (444) - Dark Green [Trim Codes H6F6, D6F6]
 - (666) - Ember Gold [Trim Codes H6Y3, D6Y3]
- ***Satellite Sebring Plus & GTX Trim Codes - H6X9, H6XW, H6B5, H6F6, H6Y3
 ***Roadrunner Trim Codes - D6X9, D6XW, D6B5, D6F6, D6Y3

1973 SATELLITE SEBRING PLUS & ROADRUNNER

This Legendary product features as-original Shallow Elk grain inserts with buttons & Cologne grain skirts.

Front BucketsAA72CRX0010(C)
 100, 200.....\$547/pr.
 352.....\$547/pr. (L4)
 253, 449.....\$909/pr. (L1)
 675.....\$1285/pr. (L1)
 *Molded foam is available for this model.

Center Cushion/Armrest.....CR71CRWX013(C)
 100, 200, 250, 340, 444.....\$ 99/ea.
 672.....\$238/ea. (L1)

Rear Bench.....AA72CRX0040(C)
 100, 200.....\$375/ea.
 352.....\$375/ea. (L4)
 253, 449.....\$743/pr. (L4)
 675.....\$1107/pr. (L1)

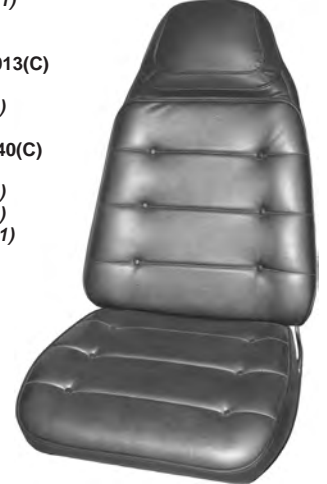
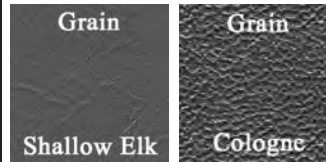

(C) COLOR CODES:

- (100) - Black [Trim Codes H6X9, D6X9]
 - (200) - White [Trim Codes H6XW, D6XW]
 - (253) - Metallic Parchment (252) / Parchment (250) [Trim Codes H6L3, D6L3]
 - (352) - Bright Blue (341) / Bright Blue (340) [Trim Codes H6B5, D6B5]
 - (449) - Metallic Green (448) / Dark Green (444) [Trim Codes H6F6, D6F6]
 - (675) - Metallic Bronze (674) / Honey Gold (672) [Trim Codes H6Y4, D6Y4]
- ***Satellite Sebring Plus Trim Codes - H6X9, H6XW, H6L3, H6B5, H6F6, H6Y4
 ***Roadrunner Trim Codes - D6X9, D6XW, D6L3, D6B5, D6F6, D6Y4

1974 SATELLITE SEBRING PLUS & ROADRUNNER "CLOTH STYLE"

This Legendary product features as-original Wimbledon Cloth inserts with Oxford grain skirts.

(C) COLOR CODES:
 (941) - Red, Black & White Cloth (940) / White (200) [Trim Codes E5EW, W5EW]
 ***Satellite Sebring Plus Trim Code - E5EW
 ***Roadrunner Trim Code - W5EW



Front BucketsAA74CRC0010(C)
 941\$1007/pr. (L1)
 *Molded foam is available for this model. Please see the "Molded Foam" section in this catalog.

Center Cushion/Armrest.....CR71CRWXF13(C)
 200.....\$99/ea.

Rear Bench.....AA74CRC0040(C)
 941.....\$813/ea. (L1)

1974 SATELLITE SEBRING PLUS & ROADRUNNER

This Legendary product features as-original Shallow Elk grain inserts with buttons & Oxford grain skirts.

Front BucketsAA74CRX0010(C)
 100, 200, 360, 450.....\$547/pr.
 680.....\$1285/pr. (L1)
 *Molded foam is available for this model.

Center Cushion/Armrest.....CR71CRWXF13(C)
 100, 200, 360, 450.....\$ 99/ea.
 680.....\$238/ea. (L1)

Rear Bench.....AA74CRX0040(C)
 100, 200, 360, 450.....\$375/ea.
 680.....\$1107/ea. (L1)



(C) COLOR CODES:

- (100) - Black [Trim Codes H6X9, D6X9]
 - (200) - White [Trim Codes H6XW, D6XW]
 - (360) - Lagoon Blue [Trim Codes H6B6, D6B6]
 - (450) - Jade Green [Trim Codes H6G6, D6G6]
 - (680) - Ember Gold [Trim Codes H6Y3, D6Y3]
- ***Satellite Sebring Plus Trim Codes - H6X9, H6XW, H6B6, H6G6, H6Y3
 ***Roadrunner Trim Codes - D6X9, D6XW, D6B6, D6G6, D6Y3

1964 SAVOY "CLOTH STYLE"

This Legendary product features as-original Cloth inserts with Bison grain skirts.

(C) COLOR CODES:

- (381) - Blue Cloth (380) / Blue (302) / Powder Blue (331) [Trim Code L1B]
- (581) - Red Cloth (580) / Dark Red (504) / Crimson Red (510) [Trim Code L1R]
- (696) - Tan Cloth (691) / Fawn Tan (610) / Taupe (209) [Trim Code L1T]

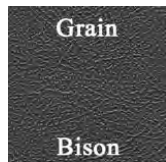

- Front Split Bench..... **AA64CSC0020(C)**
(All colors)..... \$1059/ea. (L1)
- 2-Door Sedan Rear Bench..... **AA64CSC0080(C)**
(All colors)..... \$813/ea. (L1)

1965 BELVEDERE II

This Legendary product features as-original Cologne grain inserts with Cologne grain accent & Bison grain skirts.

(C) COLOR CODES:

- (100) - Black / Black with Black Accent [Trim Code H4X]
- (326) - Navy (320) / Light Blue (314) with Navy Accent [Trim Code H4B]
- (423) - Dark Turquoise (414) / Light Turquoise (416)
with Dark Turquoise Accent [Trim Code H4Q]
- (518) - Maroon (526) / Crimson Red (510) with Maroon Accent [Trim Code H4R]
- (531) - Maroon (526) / Crimson Red (510)
with Maroon Accent & Silver Tinsel Welt [Trim Code H4R]
- (631) - Dark Gold (624) / Light Gold (614) with Dark Gold Accent [Trim Code H4Y]

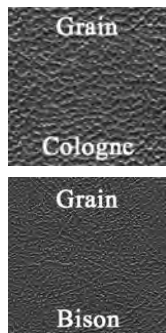

- Front Split Bench..... **AA65CR20020(C)**
100, 326, 423, 518, 538..... \$638/ea.
631..... \$994/ea. (L4)
- Hardtop Rear Bench..... **AA65CR20080(C)**
- Convertible Rear Bench..... **AA65CR20060(C)**
100, 326, 423, 518, 538..... \$454/ea.
631..... \$838/ea. (L4)
- Convertible Rear Bench Back Panel..... **SK65CR00019(C)**
100, 314, 416, 510, 614..... \$75/ea.

1965 BELVEDERE I "CLOTH STYLE"

This Legendary product features as-original Cloth inserts with Bison grain skirts.

(C) COLOR CODES:

- (893) - Blue Cloth (896) / Blue (314) [Trim Code L1B]
- (894) - Red Cloth (897) / Crimson Red (510) [Trim Code L1R]
- (895) - Tan Cloth (898) / Fawn Tan (610) [Trim Code L1T]

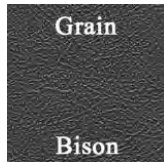

- Front Split Bench..... **AA65CR1C020(C)**
(All colors)..... \$1041/ea. (L1)
- 2-Door Sedan Rear Bench..... **AA65CR1C080(C)**
(All colors)..... \$797/ea. (L1)

1965 BELVEDERE II "CLOTH STYLE"

This Legendary product features as-original Cloth inserts with Cologne grain accents & Bison grain skirts.

(C) COLOR CODES:

- (701) - Blue Cloth (700) / Light Blue (314) with Navy Accent [Trim Code H1B]
- (703) - Tan Cloth (702) / Fawn Tan (610) with Dark Brown Accent [Trim Code H1T]
- (705) - Red Cloth (704) / Crimson Red (510) with Maroon Accent [Trim Code H1R]
- (707) - Turquoise Cloth (706) / Light Turquoise (416)
with Dark Turquoise Accent [Trim Code H1Q]
- (709) - Gold Cloth (708) / Light Gold (614) with Dark Gold Accent [Trim Code H1Y]

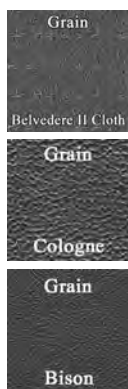

- Front Split Bench..... **AA65CR2C020(C)**
701, 705, 707..... \$1117/ea. (L1)
703, 709..... \$1222/ea. (L1)
- Hardtop Rear Bench..... **AA65CR2C080(C)**
701, 705, 707..... \$921/ea. (L1)
703, 709..... \$1037/ea. (L1)



1966 BELVEDERE I "CLOTH STYLE"

This Legendary product features as-original Cloth inserts with 1/4 Rib vinyl grain top insert & Cologne grain skirts.

(C) COLOR CODES:

- (715) - Gold Cloth (714) / Light Gold (618) [Trim Code L1T]
- (717) - Red Cloth (716) / Red (520) [Trim Code L1R]
- (718) - Dark Blue Cloth (712) / Light Blue (318) [Trim Code L1B]

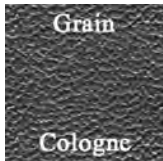

Front Split Bench.....	AA66CR1C028(C)
717, 718.....	\$1041/ea. (L1)
715.....	\$1339/ea. (L1)
2-Door Sedan Rear Bench.....	AA66CR1C080(C)
717, 718.....	\$825/ea. (L1)
715.....	\$1177/ea. (L1)

1966 BELVEDERE II 2-DOOR, 4-DOOR & WAGON

This Legendary product features as-original Crater grain inserts with Cologne grain skirts.

(C) COLOR CODES:

- (100) - Black [Trim Code H4X]
- (327) - Navy (320) / Light Blue (318) [Trim Code H4B]
- (415) - Dark Turquoise (414) / Light Turquoise (416) [Trim Code H4Q]
- (429) - Green (440) / Citron (420) [Trim Code H4Y]
- (520) - Red [Trim Code H4R]
- (619) - Gold (614) / Light Gold (618) [Trim Code H4T]



Front Split Bench (2-Door).....	AA66CR20020(C)
100, 327, 429, 520.....	\$547/ea.
619.....	\$1029/ea. (L1)
Front Straight Bench (4-Door / Wagon).....	AA66CR20024(C)
327, 415, 520.....	\$547/ea.
619.....	\$1029/ea. (L1)
2-Door Hardtop Rear Bench.....	AA66CR20080(C)
Convertible Rear Bench.....	AA66CR20060(C)
100, 327, 429, 520.....	\$384/ea.
619.....	\$837/ea. (L1)
4-Door Sedan Rear Bench.....	AA66CR20084(C)
327, 415, 520.....	\$384/ea.
619.....	\$837/ea. (L1)

1966 BELVEDERE II "CLOTH STYLE"

This Legendary product features as-original Cloth inserts with Cologne grain skirts.

(C) COLOR CODES:

- (721) - Dark Blue Cloth (720) / Light Blue (318) [Trim Code H1B]
- (723) - Turquoise Cloth (722) / Light Turquoise (416) [Trim Code H1Q]
- (725) - Gold Cloth (724) / Light Gold (618) [Trim Code H1T]
- (727) - Dark Green Cloth (726) / Citron (420) [Trim Code H1Y]
- (729) - Red Cloth (728) / Red (520) [Trim Code H1R]

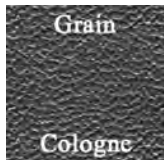

Front Split Bench.....	AA66CR2C028(C)
721, 723, 727, 729.....	\$1041/ea. (L1)
725.....	\$1339/ea. (L1)
Hardtop Rear Bench.....	AA66CR2C080(C)
721, 723, 727, 729.....	\$825/ea. (L1)
725.....	\$1177/ea. (L1)

1967 BELVEDERE II 2-DOOR, 4-DOOR & WAGON

This Legendary product features as-original Bambino grain inserts with Cologne grain skirts.

(C) COLOR CODES:

- (100) - Black [Trim Code H4X]
- (202) - Pearl White [Trim Codes H4W, H4P]
- (327) - Navy (320) / Light Blue (318) [Trim Code H4B]
- (520) - Red [Trim Code H4R]
- (623) - Dark Brown (622) / Light Gold (618) [Trim Code H4T]
- (627) - Dark Copper (626) / Copper (620) [Trim Codes H4K, H4M]

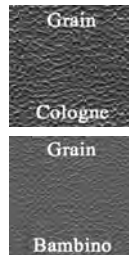

Front Split Bench (2-Door).....	AA67CRBA020(C)
100, 202, 327, 520.....	\$569/ea.
627.....	\$931/ea. (L1)
<i>*Metal emblems not included.</i>	
Front Straight Bench (4-Door / Wagon).....	AA67CRBA024(C)
100, 327, 520.....	\$569/ea.
623.....	\$1305/ea. (L1)
627.....	\$931/ea. (L1)
2-Door Hardtop Rear Bench.....	AA67CRBA080(C)
Convertible Rear Bench.....	AA67CRBA060(C)
100, 202, 327, 520.....	\$404/ea.
627.....	\$780/ea. (L1)
4-Door Sedan Rear Bench.....	AA67CRBA084(C)
100, 327.....	\$404/ea.
627.....	\$780/ea. (L1)

1967 BELVEDERE II "SILVER SPECIAL"

This Legendary product features as-original Boar grain inserts with Cologne grain skirts.

(C) COLOR CODES:

(107) - Black with Silver Casting (106) / Silver (102) [Trim Code H4A]



Front Split Bench (2-Door Hardtop).....	AA67CRBR020(C)
107.....	\$725/ea.
*Metal emblems <u>not</u> included.	
Front Straight Bench (4-Door Sedan).....	AA67CRBR024(C)
107.....	\$725/ea.
Hardtop Rear Bench.....	AA67CRBR080(C)
4-Door Sedan Rear Bench.....	AA67CRBR084(C)
107.....	\$505/ea.

1967 BELVEDERE II "CLOTH STYLE"

This Legendary product features as-original Cloth inserts with Cologne grain skirts.

(C) COLOR CODES:

(741) - Black Cloth (740) / Black (100) [Trim Code H1X]
 (743) - Dark Blue Cloth (742) / Light Blue (318) [Trim Code H1B]
 (745) - Turquoise Cloth (744) / Light Turquoise (416) [Trim Code H1Q]
 (747) - Copper Cloth (746) / Copper (620) [Trim Code H1K]
 (749) - Gold Cloth (748) / Light Gold (618) [Trim Code H1T]



Front Split Bench.....	AA67CR2C020(C)
741, 743, 745, 747.....	\$1041/ea. (L1)
749.....	\$1339/ea. (L1)
Hardtop Rear Bench.....	AA67CR2C080(C)
741, 743, 745, 747.....	\$825/ea. (L1)
749.....	\$1177/ea. (L1)

1968 BELVEDERE & ROADRUNNER "ROSETTE GRAIN" STYLE

This Legendary product features as-original Rosette grain inserts with Cologne grain skirts.

(C) COLOR CODES:

(105) - Black (100) / Silver (102) [Trim Code D4S]
 (359) - Dark Blue (330) / Light Blue (332) [Trim Code D4B]
 (633) - Light Fawn (634) / Oyster (220) [Trim Code D4L]

(C) HEADREST COLOR CODES:

(100) - Black
 (332) - Light Blue
 (634) - Light Fawn

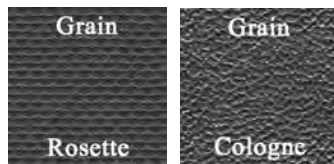

Front Split Bench.....	AA68CRR0020(C)
105, 359.....	\$547/ea.
633.....	\$953/ea. (L1)
Headrest Covers.....	HC68CLMRW14(C)
100, 330, 634.....	\$105/pr.
Rear Bench.....	AA68CRR0080(C)
105, 359.....	\$384/ea.
633.....	\$801/ea. (L1)

1968 BELVEDERE & ROADRUNNER "REED GRAIN" STYLE

This Legendary product features as-original Reed grain inserts with Cologne grain skirts.

(C) COLOR CODES:

(105) - Black (100) / Silver (102) [Trim Code D4S]
 (359) - Dark Blue (330) / Light Blue (332) [Trim Code D4B]
 (633) - Light Fawn (634) / Oyster (220) [Trim Code D4L]

(C) HEADREST COLOR CODES:

(100) - Black
 (332) - Light Blue
 (634) - Light Fawn

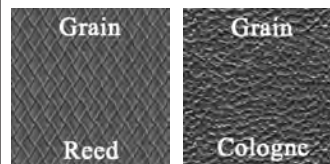

Front Split Bench.....	AA68CRWE020(C)
105, 359.....	\$547/ea.
633.....	\$953/ea. (L1)
Headrest Covers.....	HC68CLMRW14(C)
100, 330, 634.....	\$105/pr.
Rear Bench.....	AA68CRWE080(C)
105, 359.....	\$384/ea.
633.....	\$801/ea. (L1)



1968 SATELLITE & ROADRUNNER "DECOR PACKAGE"

This Legendary product features as-original
Ascot grain inserts with Bambino grain skirts.

Front Split Bench AA68CRP0020(C)
100, 202, 351, 433, 527 \$590/ea.
233 \$953/ea. (L1)
**Metal emblems not included.*

Headrest Covers HC68CR00014(C)
100, 202, 332, 430, 526, 630 \$105/pr.

Hardtop Rear Bench AA68CRP0080(C)
Convertible Rear Bench AA68CRP0060(C)
100, 202, 351, 433, 527 \$427/ea.
233 \$801/ea. (L1)
**Metal emblems not included.*



(C) COLOR CODES:

- (100) - Black [Trim Code H4X]
- (202) - Pearl White [Trim Codes H4C, H4D, H4V]
- *H4C - White w/ Blue Carpet*
- *H4D - White w/ Green Carpet*
- *H4V - White w/ Red Carpet*
- (233) - Parchment (230) / Gold (630) [Trim Code H4N]
- (351) - Light Blue (332) / Dark Blue (330) [Trim Code H4B]
- (433) - Light Green (432) / Dark Green (430) [Trim Code H4F]
- (527) - Red (520) / Maroon (526) [Trim Code H4R]

1968 SATELLITE "CLOTH STYLE"

This Legendary product features as-original
Cloth inserts with Cologne grain skirts.

(C) COLOR CODES:

- (857) - Light Green Cloth (854) / Light Green (432) [Trim Code H1F]
- (859) - Dark Blue Cloth (858) / Light Blue (332) [Trim Code H1B]
- (861) - Gold Cloth (860) / Parchment (230) [Trim Code H1N]
- (865) - Black Cloth (864) / Black (100) [Trim Code H1X]

(C) HEADREST COLOR CODES:

- (100) - Black
- (332) - Light Blue
- (430) - Dark Green
- (630) - Gold

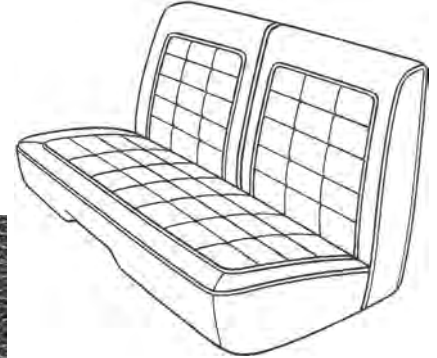

Front Split Bench AA68CRC0020(C)
857, 859, 865 \$965/ea. (L1)
861 \$1446/ea. (L1)

Headrest Covers HC68CLMRW14(C)
100, 332, 430, 630 \$105/pr.

Hardtop Rear Bench AA68CRC0080(C)
857, 859, 865 \$825/ea. (L1)
861 \$1299/ea. (L1)

1969 BELVEDERE & ROADRUNNER

This Legendary product features as-original
Rosette grain inserts with Coachman grain skirts.

(C) COLOR CODES:

- (100) - Black [Trim Code M2X]
- (359) - Dark Blue (330) / Light Blue (332) [Trim Code M2B]
- (651) - Bronze (640) / Saddle (650) [Trim Code M2T]

(C) HEADREST COLOR CODES:

- (100) - Black
- (332) - Light Metallic Blue
- (650) - Saddle

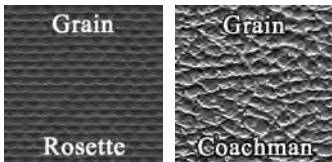

Front Split Bench AA69CRW0020(C)
(All colors) \$547/ea.

Headrest Covers HC69CRW0014(C)
(All colors) \$105/pr.

Rear Bench AA69CRW0080(C)
(All colors) \$384/ea.

1969 SATELLITE & ROADRUNNER "DECOR PACKAGE"

This Legendary product features as-original Ascot grain inserts
with Coachman grain skirts.

Front Split Bench AA69CRP0020(C)
(All colors) \$547/ea.
**Metal emblems not included.*

Headrest Covers HC69CRW0014(C)
100, 130, 200, 332, 432, 650 \$105/pr.

Hardtop Rear Bench AA69CRP0080(C)
Convertible Rear Bench AA69CRP0060(C)
(All colors) \$384/ea.
**Metal emblems not included.*

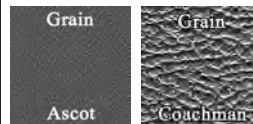

(C) COLOR CODES:

- (100) - Black [Trim Code H2X]
- (130) - Pewter [Trim Code H2S]
- (200) - White [Trim Codes H2W, H2C, H2H, H2F]
- *H2W - White w/ Black Carpet*
- *H2C - White w/ Blue Carpet*
- *H2H - White w/ Tan Carpet*
- *H2F - White w/ Green Carpet*
- (351) - Light Blue (332) / Dark Blue (330) [Trim Code H2B]
- (435) - Light Green (432) / Dark Green (434) [Trim Code H2G]
- (653) - Saddle (650) / Bronze (640) [Trim Code H2T]

1969 SATELLITE "CLOTH STYLE"

This Legendary product features as-original Cloth inserts with Coachman grain skirts.

(C) COLOR CODES:

- (870) - Black Cloth (885) / Black (100) [Trim Code H1X]
- (871) - Green Cloth (886) / Light Green (432) [Trim Code H1G]
- (872) - Blue Cloth (887) / Dark Blue (330) [Trim Code H1B]
- (873) - Gold Cloth (888) / Saddle (650) [Trim Code H1T]

(C) HEADREST COLOR CODES:

- (100) - Black
- (432) - Light Green
- (332) - Light Blue
- (650) - Saddle



Front Split Bench (2-Door Hardtop).....	AA69CRC0020(C)
870, 871, 872.....	\$965/ea. (L1)
Front Straight Bench (4-Door Sedan).....	AA69CRC0024(C)
(All colors).....	\$965/ea. (L1)
Headrest Covers.....	HC69CRW0014(C)
(All colors).....	\$105/pr.
2-Door Hardtop Rear Bench.....	AA69CRC0080(C)
870, 871, 872.....	\$825/ea. (L1)
4-Door Sedan Rear Bench.....	AA69CRC0084(C)
(All colors).....	\$825/ea. (L1)

1969 "MOD TOP" SATELLITE

This Legendary product features as-original Blue/Green Mod inserts with Coachman grain skirts.

(C) COLOR CODES:

- (365) - Blue & Green Mod (364) / Dark Metallic Blue (330) [Trim Code F2Q]

(C) HEADREST COLOR CODES:

- (330) - Dark Metallic Blue



Front Split Bench.....	AA69CRM0020(C)
365.....	\$1009/ea. (L1)
Headrest Covers.....	HC69CRW0014(C)
330.....	\$105/pr.
Hardtop Rear Bench.....	AA69CRM0080(C)
365.....	\$825/ea. (L1)

1970 BELVEDERE & ROADRUNNER

This Legendary product features as-original Laredo grain inserts with Coachman grain skirts.

(C) COLOR CODES:

- (165) - Charcoal (154) / Black (100) with Silver (104) Accent [Trim Code M2X9]
- (367) - Bright Blue (338) / Bright Blue (338) w/ Dark Blue (330) Accent [Trim Code M2B5]
- (663) - Brown (656) / Brown (656) with Dark Brown (664) Accent [Trim Code M2T5]

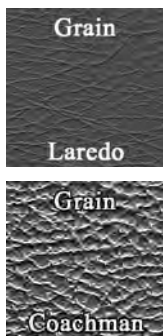

Front Split Bench.....	AA70CRS0020(C)
(All colors).....	\$547/ea.
Rear Bench.....	AA70CRS0080(C)
(All colors).....	\$350/ea.

1970 SATELLITE, ROADRUNNER & SUPERBIRD "DECOR PACKAGE"

This Legendary product features as-original Laredo grain inserts with 2 inch accent collar & Coachman grain skirts.

Front Split Bench.....	AA70CRD0020(C)
(All colors).....	\$590/ea.
<i>*Metal emblems not included.</i>	
Hardtop Rear Bench.....	AA70CRD0080(C)
Convertible Rear Bench.....	AA70CRD0060(C)
(All colors).....	\$421/ea.
<i>*Metal emblems not included.</i>	



(C) COLOR CODES:

- (103) - Black (100) with Silver (104) Accent [Trim Code H2X9]
- (200) - White with White Accent [Trim Codes H2XW, H2BW, H2KW]
- *H2XW - White w/ Black Carpet*
- *H2BW - White w/ Blue Carpet*
- *H2KW - White w/ Burnt Orange Carpet*
- (367) - Bright Blue (338) with Dark Blue (330) Accent [Trim Code H2B5]
- (443) - Dark Green (434) with Light Green (432) Accent [Trim Code H2F8]
- (540) - Burnt Orange with Burnt Orange Accent [Trim Code H2K4]
- (663) - Brown (656) with Dark Brown (664) Accent [Trim Code H2T5]



**1970 SATELLITE
"CLOTH STYLE"**

This Legendary product features as-original Cloth inserts with Coachman grain skirts.

(C) COLOR CODES:

- (771) - Black Cloth (770) / Black (100) [Trim Code H1X9]
- (773) - Dark Blue Cloth (772) / Bright Blue (338) [Trim Code H1B5]
- (777) - Dark Green Cloth (776) / Dark Green (434) [Trim Code H1F8]



- Front Split Bench..... AA70CRC0020(C)
771, 773, 777..... \$1011/ea. (L1)
- Hardtop Rear Bench..... AA70CRC0080(C)
771, 773, 777..... \$825/ea. (L1)

**1970 SPORT SATELLITE & GTX
"CLOTH STYLE"**

This Legendary product features as-original Geometric inserts with Coachman grain skirts.

(C) COLOR CODES:

- (961) - Black Geometric Cloth (960) / Black (100) [Trim Code P3X9]
- (963) - Bright Blue Geometric Cloth (964) / Dark Blue (330) [Trim Code P3B7]
- (965) - Bright Blue Geometric Cloth (964) / Bright Blue (338) [Trim Code P3B5]
- (967) - Dark Green Geometric Cloth (966) / Dark Green (434) [Trim Code P3F8]
- (969) - Burnt Orange Geometric Cloth (968) / Burnt Orange (540) [Trim Code P3K4]
- (971) - Gold Geometric Cloth (970) / Gold (660) [Trim Code P3Y4]



- Front Split Bench with Center Armrest AA70CRCG030(C)
961, 963, 965, 967, 969..... \$1034/ea. (L1)
971..... \$1542/ea. (L1)
**963, 967 & 971 color codes were available in 4-door Sedan models only.*
- Rear Bench..... AA70CRCG080(C)
961, 965, 969..... \$825/ea. (L1)
**Rear Bench not available for 4-door Sedan models.*

1971 SATELLITE & ROADRUNNER

This Legendary product features as-original El Paso grain inserts with Coachman grain skirts.

(C) COLOR CODES:

- (168) - Charcoal (156) / Black (100) [Trim Code M2X9]
- (340) - Bright Blue [Trim Code M2B5]
- (665) - Tan (668) / Brown (664) [Trim Code M2T7]

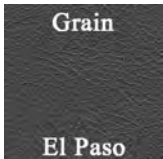

- Front Split Bench..... AA71CRXS020(C)
(All colors)..... \$547/ea.
- Rear Bench..... AA71CRXS080(C)
(All colors)..... \$384/ea.

**1971 SATELLITE SEBRING &
ROADRUNNER "DECOR PACKAGE"**

This Legendary product features as-original Shallow Elk grain inserts with Coachman grain skirts.

(C) COLOR CODES:

- (100) - Black [Not a factory option]
**Black was not originally offered, but may be purchased as a special order. Available only as a prepaid, non-refundable and non-returnable order.*
- (140) - Gunmetal [Trim Code H2XA]
- (155) - Charcoal (156) / Black (100) [Trim Code H2X9]
- (200) - White [Trim Code H2XW]
- (340) - Bright Blue [Trim Code H2B5]
- (451) - Light Green (432) / Dark Green (452) [Trim Code H2F7]
- (665) - Tan (668) / Brown (664) [Trim Code H2T7]
- (666) - Ember Gold [Trim Code H2Y3]



- Front Split Bench..... AA71CRD0020(C)
(All colors)..... \$547/ea.
**Metal emblems not included.*
- Rear Bench..... AA71CRD0080(C)
(All colors)..... \$384/ea.
**Metal emblems not included.*

1972 SATELLITE & ROADRUNNER

This Legendary product features as-original
Shallow Elk grain inserts with Coachman grain skirts.

(C) COLOR CODES:

- (168) - Charcoal (156) / Black (100) [Trim Code B2X9]
- (340) - Bright Blue [Trim Code B2B5]
- (445) - Light Green (432) / Dark Green (444) [Trim Code B2F6]

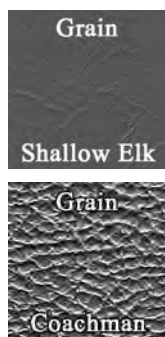

- Front Split Bench..... **AA72CRXS020(C)**
(All colors)..... \$547/ea.
- Rear Bench..... **AA72CRXS080(C)**
(All colors)..... \$375/ea.

1972 SATELLITE SEBRING & ROADRUNNER "DECOR PACKAGE"

This Legendary product features as-original heat sealed
Shallow Elk grain inserts with Coachman grain skirts.

(C) COLOR CODES:

- (100) - Black [Trim Code C2X9]
- (200) - White [Trim Code C2XW]
- (340) - Bright Blue [Trim Code C2B5]
- (444) - Dark Green [Trim Code C2F6]
- (662) - Brown [Trim Code C2T5]
- (666) - Ember Gold [Trim Code C2Y3]



- Front Split Bench..... **AA72CRD0020(C)**
(All colors)..... \$547/ea.
**Metal emblems not included.*
- Rear Bench..... **AA72CRD0080(C)**
(All colors)..... \$384/ea.
**Metal emblems not included.*

1973 SATELLITE SEBRING & ROADRUNNER "DECOR PACKAGE"

This Legendary product features as-original
Shallow Elk grain inserts with Coachman grain skirts.

(C) COLOR CODES:

- (100) - Black [Trim Code C2X9]
- (253) - Metallic Parchment (252) / Parchment (250) [Trim Code C2L3]
- (352) - Bright Blue (341) / Bright Blue (340) [Trim Code C2B5]
- (449) - Metallic Green (448) / Dark Green (444) [Trim Code C2F6]
- (675) - Metallic Bronze (674) / Honey Gold (672) [Trim Code C2Y4]



- Front Split Bench..... **AA73CRXD020(C)**
100..... \$547/ea.
253, 449..... \$909/ea. (L1)
352..... \$506/ea. (L4)
675..... \$1326/ea. (L1)
**Metal emblems not included.*
- Rear Bench..... **AA73CRXD080(C)**
100..... \$384/ea.
253, 449..... \$718/ea. (L1)
352..... \$356/ea. (L4)
675..... \$1124/ea. (L1)
**Metal emblems not included.*

1974 SATELLITE SEBRING & ROADRUNNER "DECOR PACKAGE"

This Legendary product features as-original
Shallow Elk grain inserts with Oxford grain skirts.

(C) COLOR CODES:

- (100) - Black [Trim Code C2X9]
- (267) - Metallic Parchment (266) / Parchment (264) [Trim Code C2L3]
- (360) - Lagoon Blue [Trim Code C2B6]
- (450) - Jade Green [Trim Code C2G6]
- (680) - Ember Gold [Trim Code C2Y3]



- Front Split Bench..... **AA74CRD0020(C)**
100, 360, 450..... \$547/ea.
267, 680..... \$1339/ea. (L1)
**Metal emblems not included.*
- Rear Bench..... **AA74CRD0080(C)**
100, 360, 450..... \$384/ea.
267, 680..... \$1177/ea. (L1)
**Metal emblems not included.*



1974 SATELLITE SEBRING PLUS "CLOTH STYLE"

This Legendary product features as-original
Cloth inserts with buttons & Oxford grain skirts.

(C) COLOR CODES:

- (927) - Black Cloth (920) / Black (100) [Trim Code V3X9]
- (929) - Jade Green Cloth (922) / Jade Green (450) [Trim Code V3G6]
- (932) - Blue Cloth (924) / Lagoon Blue (360) [Trim Code V3B6]
- (935) - Gold Cloth (926) / Ember Gold (680) [Trim Code V3Y3]



- Front Split Bench with Center Armrest (all cloth c.a.r.) **AA74CRXC030(C)**
- Front Split Bench with Center Armrest (cloth & vinyl c.a.r.) **AA74CRXC030(C)**
- 927, 929, 932** \$986/ea. (L1)
- 935** \$1358/ea. (L1)
- Rear Bench **AA74CRXC080(C)**
- 927, 929, 932** \$825/ea. (L1)
- 935** \$1177/ea. (L1)

1967 CHARGER

This Legendary product features as-original
Bambino grain inserts with Cologne grain skirts.

(C) COLOR CODES:

- (100) - Black [Trim Code S6X]
- (202) - Pearl White [Trim Code S6W]
- (320) - Navy [Trim Code S6B]
- (520) - Red [Trim Code S6R]
- (620) - Copper [Trim Code S6K]
- (630) - Gold [Trim Code S6E]



- Front Buckets **AA67CW0010(C)**
- (All colors) \$542/pr.
- *Please specify cordwelt size. Small will be used unless specified at time of order.
- *Molded foam is available for this model. See the "Molded Foam" section in this catalog.
- Front Bucket Seatback Panels **SK66CW0018(C)**
- (Pre-sewn vinyl and carpet lower seatback panel kit)
- (All colors) \$92/pr.
- *Refer to carpet color selection at time of order.
- Rear Buckets **AA67CX00070(C)**
- (All colors) \$375/ea.
- Rear Bucket Seatback Panels **SK66CX00019(C)**
- (Pre-cut carpet seatback panel kit)
- (All colors) \$51/pr.
- *Refer to carpet color selection at time of order.

1966 CHARGER

This Legendary product features as-original
Cologne grain inserts with Cologne grain skirts.

(C) COLOR CODES:

- (100) - Black [Trim Code P4X]
- (202) - Pearl White [Trim Code P4W]
- (320) - Navy [Trim Code P4D]
- (420) - Citron [Trim Code P4Y]
- (520) - Red [Trim Code P4R]
- (617) Ginger (616) / Gold (614) [Trim Code P4T]

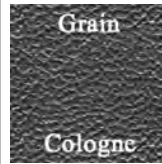

- Front Buckets **AA66CW0010(C)**
- (All colors) \$542/pr.
- *Please specify cordwelt size. Small will be used unless specified at time of order.
- *Molded foam is available for this model. Please see the "Molded Foam" section in catalog.
- Front Bucket Seatback Panels **SK66CW0018(C)**
- (Pre-sewn vinyl and carpet lower seatback panel kit)
- (All colors) \$92/pr.
- *Refer to carpet color selection at time of order.
- Rear Buckets **AA66CX00070(C)**
- (All colors) \$375/pr.
- Rear Bucket Seatback Panels **SK66CX00019(C)**
- (Pre-cut carpet seatback panel kit)
- (All colors) \$51/pr.
- *Refer to carpet color selection at time of order.

1968 CHARGER & CHARGER R/T

This Legendary product features as-original Ascot grain inserts
with Dorchester grain skirts with Cologne grain pleats.

- Front Buckets **AA68CX00010(C)**
- 100, 109, 111, 202, 357, 431, 527** ... \$647/pr.
- 637** \$889/pr. (L1)
- *Molded foam is available for this model.
- Front Bucket Seatback Panels **SK68CX00018(C)**
- (New boards wrapped in vinyl with mounting hardware attached as original. Ready to install.)
- 100, 202, 332, 430, 520, 636** \$167/pr.
- Center Cushion/Armrest
- (with map pocket) **CR68CX00013(C)**
- (without map pocket) **CR68CX00013(C)N**
- 100, 202, 332, 430, 520, 636** \$99/ea.
- Rear Bench **AA68CX00040(C)**
- 100, 109, 111, 202, 357, 431, 527** ... \$448/pr.
- 637** \$671/pr. (L1)



(C) COLOR CODES:

- (100) - Black with Black pleats [Not a factory option]
- *Black was not originally offered, but may be purchased as a special order.
- Available only as a prepaid, non-refundable and non-returnable order.
- (109) - Black (100) with Dark Grey (125) pleats [Trim Code C6X]
- (111) - Black (100) with Silver (102) pleats
- (202) - Pearl White with Pearl White pleats [Trim Codes C6W, C6C, C6D, C6E, C6V]
- *C6W - White w/ Black Carpet
- *C6C - White w/ Blue Carpet
- *C6D - White w/ Green Carpet
- *C6E - White w/ Gold Carpet
- *C6V - White w/ Red Carpet
- (357) - Light Blue (332) with Navy (320) Pleats [Trim Code C6B]
- (431) - Dark Green (430) with Light Green (432) pleats [Trim Code C6F]
- (527) - Red (520) with Maroon (526) pleats [Trim Code C6R]
- (637) - Ember Gold (636) with Parchment (230) pleats [Trim Code C6Y]

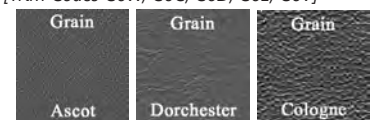

1968 CHARGER & CHARGER R/T "RALLYE SEAT"

This Legendary product features as-original Ascot grain inserts with Dorchester grain skirts with Cologne grain pleats.

(C) COLOR CODES:

- (100) - Black with Black pleats
- (109) - Black (100) with Dark Grey (125) pleats
- (111) - Black (100) with Silver (102) pleats
- (202) - Pearl White with Pearl White pleats
- (357) - Light Blue (332) with Navy (320) Pleats
- (431) - Dark Green (430) with Light Green (432) pleats
- (527) - Red (520) with Maroon (526) pleats
- (637) - Ember Gold (636) with Parchment (230) pleat



Front Buckets	RS68CX00010(C) 
100, 109, 111, 202, 357, 431, 527	\$1046/pr.
637	\$1451/pr. (L1)
<i>*Kit consists of: (1) pair Rallye Bucket Seat Upholstery, (1) set Rallye Bucket Seat Foam, (4) Front Seat Top Spring to Frame Hold Back Listing, (1 yd) Muslin, (30 ft) Listing Wire, (2 yds) Burlap, (9 ft) 2 inch Felt and (1) Dust Mask.</i>	
Front Bucket Seatback Panels	SK68CX00018(C)
<i>(New boards wrapped in vinyl with mounting hardware attached as original. Ready to install.)</i>	
100, 202, 332, 430, 520, 636	\$167/pr.
Center Cushion/Armrest	
<i>(with map pocket)</i>	CR68CX00013(C)
<i>(without map pocket)</i>	CR68CX0013(C)N
100, 202, 332, 430, 520, 636	\$99/ea.
Rear Bench	AA68CX00040(C)
100, 109, 111, 202, 357, 431, 527	\$448/pr.
637	\$671/pr. (L1)

1969 CHARGER, CHARGER R/T, CHARGER 500 & DAYTONA

This Legendary product features as-original Ascot grain inserts with Coachman grain skirts.

(C) COLOR CODES:

- (100) - Black [Trim Code C6X]
- (200) - White [Trim Code C6W]
- (330) - Blue [Trim Code C6D]
- (434) - Green [Trim Code C6G]
- (528) - Red [Trim Code C6R]
- (650) - Saddle [Trim Code C6T]

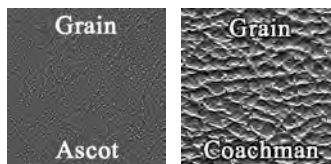

Front Buckets	AA69CX00010(C)
(All colors)	\$547/pr.
<i>*Molded foam is available for this model. See the "Molded Foam" section in this catalog.</i>	
Front Bucket Seatback Panels	SK69AB00018(C)
<i>(New boards wrapped in vinyl with mounting hardware attached as original. Ready to install.)</i>	
(All colors)	\$167/pr.
Center Cushion/Armrest	
<i>(with map pocket)</i>	CR69CRWX013(C)
<i>(without map pocket)</i>	CR69CRWX13(C)N
(All colors)	\$99/ea.
Rear Bench	AA69CX00040(C)
(All colors)	\$384/ea.

1969 CHARGER & DAYTONA "RALLYE SEAT"

This Legendary product features as-original Ascot grain inserts with Coachman grain skirts.

(C) COLOR CODES:

- (100) - Black
- (200) - White
- (330) - Blue
- (434) - Green
- (528) - Red
- (650) - Saddle

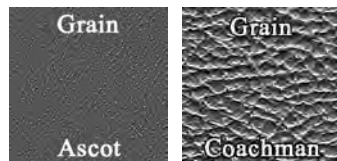

Front Buckets	RS69CX00010(C) 
(All colors)	\$925/pr.
<i>*Kit consists of: (1) pair Rallye Bucket Seat Upholstery, (1) set Rallye Bucket Seat Foam, (4) Front Seat Top Spring to Frame Hold Back Listing, (1 yd) Muslin, (30 ft) Listing Wire, (2 yds) Burlap, (9 ft) 2 inch Felt and (1) Dust Mask.</i>	
Front Bucket Seatback Panels	SK69AB00018(C)
<i>(New boards wrapped in vinyl with mounting hardware attached as original. Ready to install.)</i>	
(All colors)	\$167/pr.
Center Cushion/Armrest	
<i>(with map pocket)</i>	CR69CRWX013(C)
<i>(without map pocket)</i>	CR69CRWX13(C)N
(All colors)	\$99/ea.
Rear Bench	AA69CX00040(C)
(All colors)	\$384/ea.

1969 CHARGER "DUKES OF HAZZARD"

This Legendary product features as-original Ascot grain inserts with Coachman grain skirts.

(C) COLOR CODES:

- (670) - "Dukes" Tan

**(670) TAN WAS NOT OFFERED AS AN ORIGINAL COLOR IN 1969 CHARGER MODELS, BUT MAY BE PURCHASED AS A SPECIAL ORDER. AVAILABLE ONLY AS A PREPAID, NON-REFUNDABLE AND NON-RETURNABLE ORDER WITH OUR LIFETIME FACTORY WARRANTY.*

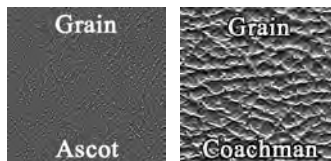

Front Buckets	AA69CX00010(C)
*670	\$590/pr.
<i>*Molded foam is available for this model. See the "Molded Foam" section in this catalog.</i>	
Front Bucket Seatback Panels	SK69AB00018(C)
<i>(New boards wrapped in vinyl with mounting hardware attached as original. Ready to install.)</i>	
*670	\$167/pr.
Center Cushion/Armrest	
<i>(with map pocket)</i>	CR69CRWX013(C)
<i>(without map pocket)</i>	CR69CRWX13(C)N
*670	\$99/ea.
Rear Bench	AA69CX00040(C)
*670	\$404/ea.



**1969 CHARGER "DUKES OF HAZZARD"
"RALLYE SEAT"**

This Legendary product features as-original Ascot grain inserts with Coachman grain skirts.

(C) COLOR CODES:
(670) - "Dukes" Tan

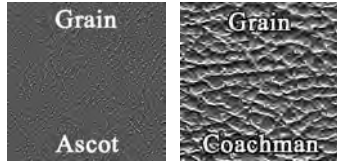

- Front Buckets **RS69CX00010(C)**  ***670** \$953/pr.
- *Kit consists of: (1) pair Rallye Bucket Seat Upholstery, (1) set Rallye Bucket Seat Foam, (4) Front Seat Top Spring to Frame Hold Back Listing, (1 yd) Muslin, (30 ft) Listing Wire, (2 yds) Burlap, (9 ft) 2 inch Felt and (1) Dust Mask.*
- Front Bucket Seatback Panels **SK69AB00018(C)**
(New boards wrapped in vinyl with mounting hardware attached as original. Ready to install.)
***670** \$167/pr.
- Center Cushion/Armrest
(with map pocket) **CR69CRWX013(C)**
(without map pocket) **CR69CRWX13(C)N**
***670** \$99/ea.
- Rear Bench **AA69CX00040(C)**
***670** \$404/ea.

**1969 CHARGER, R/T, 500 & DAYTONA
"CLOTH STYLE"**

This Legendary product features as-original Cloth inserts with Coachman grain skirts.

(C) COLOR CODE:
(100) - Black Cloth [Trim Code C5X]

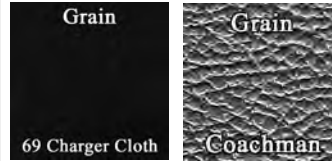

- Front Buckets **AA69CXC0010(C)**
100 \$956/pr. (L1)
**Molded foam is available for this model. See the "Molded Foam" section in this catalog.*
- Front Bucket Seatback Panels **SK69AB00018(C)**
(New boards wrapped in vinyl with mounting hardware attached as original. Ready to install.)
100 \$167/pr.
- Center Cushion/Armrest
(with map pocket) **CR69CRWX013(C)**
(without map pocket) **CR69CRWX13(C)N**
100 \$99/ea.
- Rear Bench **AA69CXC0040(C)**
100 \$765/ea. (L1)

**1969 CHARGER, R/T, 500 & DAYTONA
"CLOTH RALLYE STYLE"**

This Legendary product features as-original Cloth inserts with Coachman grain skirts.

(C) COLOR CODE:
(100) - Black Cloth



- Front Buckets **RS69CXC0010(C)**  **100** \$916/pr. (L1)
**Kit consists of: (1) pair Rallye Bucket Seat Upholstery, (1) set Rallye Bucket Seat Foam, (4) Front Seat Top Spring to Frame Hold Back Listing, (1 yd) Muslin, (30 ft) Listing Wire, (2 yds) Burlap, (9 ft) 2 inch Felt and (1) Dust Mask.*
- Front Bucket Seatback Panels **SK69AB00018(C)**
(New boards wrapped in vinyl with mounting hardware attached as original. Ready to install.)
100 \$167/pr.
- Center Cushion/Armrest
(with map pocket) **CR69CRWX013(C)**
(without map pocket) **CR69CRWX13(C)N**
100 \$99/ea.
- Rear Bench **AA69CXC0040(C)**
100 \$765/ea. (L1)

**1969 CHARGER SE & CHARGER R/T SE
"LEATHER STYLE"**

This Legendary product features as-original Leather inserts with Coachman grain skirts.

(C) COLOR CODES:
(100) - Black [Trim Code CRX]
(330) - Dark Blue [Trim Code CRD]
(434) - Dark Green [Trim Code CRG]
(650) - Saddle [Trim Code CRT]



- Front Buckets **AA69CXL0010(C)**
100 \$999/pr. (L3)
330, 434, 650 \$1219/pr. (L3)
**Molded foam is available for this model. See the "Molded Foam" section in this catalog.*
- Front Bucket Seatback Panels **SK69AB00018(C)**
(New boards wrapped in vinyl with mounting hardware attached as original. Ready to install.)
(All colors) \$167/pr.
- Center Cushion/Armrest
(with map pocket) **CR69CRWX013(C)**
(without map pocket) **CR69CRWX13(C)N**
(All colors) \$99/ea.
- Rear Bench *(all vinyl Coachman)* **AA69CXL0040(C)**
(All colors) \$384/ea.

1969 CHARGER SE & CHARGER R/T SE "LEATHER RALLYE STYLE"

This Legendary product features as-original
Leather inserts with Coachman grain skirts.

(C) COLOR CODES:

- (100) - Black
- (330) - Dark Blue
- (434) - Dark Green
- (650) - Saddle



Front Buckets	RS69CXL0010(C)
100	\$1014/pr. (L3)
330, 434, 650	\$1342/pr. (L3)

*Kit consists of: (1) pair Rallye Bucket Seat Upholstery, (1) set Rallye Bucket Seat Foam, (4) Front Seat Top Spring to Frame Hold Back Listing, (1 yd) Muslin, (30 ft) Listing Wire, (2 yds) Burlap, (9 ft) 2 inch Felt and (1) Dust Mask.

Front Bucket Seatback Panels	SK69AB00018(C)
(New boards wrapped in vinyl with mounting hardware attached as original. Ready to install.)	
(All colors)	\$167/pr.

Center Cushion/Armrest	
(with map pocket)	CR69CRWX013(C)
(without map pocket)	CR69CRWX13(C)N
(All colors)	\$99/ea.

Rear Bench	AA69CXL0040(C)
(All colors)	\$384/ea.

1970 CHARGER R/T SE & CHARGER 500 SE "LEATHER STYLE"

This Legendary product features as-original Diamond Basketweave Leather
inserts with leather collars & Krinkle grain skirts

(C) COLOR CODES:

- (100) - Black with Black pleats [Not a factory option]
*Black was not originally offered, but may be purchased as a special order. Available only as a prepaid, non-refundable and non-returnable order.
- (154) - Charcoal [Trim Code CRXA]
- (338) - Bright Blue [Trim Code CRB5]
- (434) - Dark Green [Trim Code CRF8]
- (656) - Brown [Trim Code CRT5]

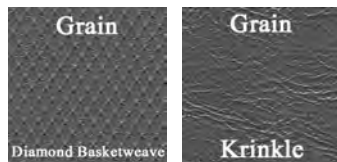

Front Buckets	AA70CXL0010(C)
*100	\$1139/pr. (L3)
154, 338, 434, 656	\$1490/pr. (L3)

*Molded foam is available for this model. See the "Molded Foam" section in this catalog.

Center Cushion/Armrest	
(with map pocket)	CR70CX00013(C)
(without map pocket)	CR70CX0013(C)N
(All colors)	\$99/ea.

Rear Bench (all vinyl)	AA70CX00048(C)
(All colors)	\$427/ea.

1970 CHARGER, CHARGER R/T & CHARGER 500

This Legendary product features as-original
Diamond Basketweave grain inserts with Krinkle grain skirts.

(C) COLOR CODES:

- (100) - Black [Not a factory option]
*Black was not originally offered, but may be purchased as a special order. Available only as a prepaid, non-refundable and non-returnable order.
- (154) - Charcoal [Trim Code C6XA]
- (200) - White [Trim Code C6XW]
- (338) - Bright Blue [Trim Code C6B5]
- (434) - Dark Green [Trim Code C6F8]
- (540) - Burnt Orange [Trim Code C6K4]
- (656) - Brown [Trim Code C6T5]



Front Buckets	AA70CX00010(C)
(All colors)	\$647/pr.
*Molded foam is available for this model. See the "Molded Foam" section in this catalog.	

Center Cushion/Armrest	
(with map pocket)	CR70CX00013(C)
(without map pocket)	CR70CX0013(C)N
(All colors)	\$99/ea.

Rear Bench	AA70CX00048(C)
(All colors)	\$427/ea.

1970 CHARGER, R/T & 500 "CLOTH STYLE"

This Legendary product features as-original
Salt & Pepper cloth inserts with Krinkle grain skirts.

(C) COLOR CODE:

- (813) - Black & White Salt & Pepper Cloth (810) / Charcoal (154) [Trim Code C5XA]

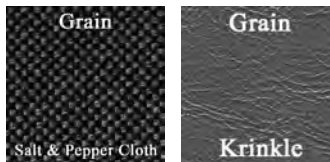

Front Buckets	AA70CXC0010(C)
813	\$1006/pr. (L4)
*Molded foam is available for this model. See the "Molded Foam" section in this catalog.	

Center Cushion/Armrest	
(with map pocket)	CR70CX00013(C)
(without map pocket)	CR70CX0013(C)N
154	\$99/ea.

Rear Bench	AA70CXC0040(C)
813	\$751/ea. (L4)



1971 CHARGER R/T, CHARGER 500 & SUPERBEE

This Legendary product features as-original El Paso grain inserts with Coachman grain skirts.

Front BucketsAA71CRX0010(C)
 (All colors).....\$547/pr.
 *Molded foam is available for this model.

Center Cushion/Armrest.....CR71CRWXH13(C)
 (All colors).....\$99/ea.

Rear Bench.....AA71CRX0040(C)
 (All colors).....\$450/ea.

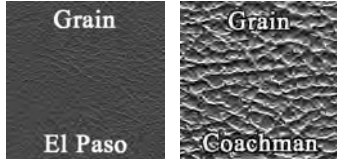

(C) COLOR CODES:

- (100) - Black [Trim Codes D6X9, C6X9]
- (140) - Gunmetal [Trim Codes D6XA, C6XA]
- (200) - White [Trim Codes D6XW, C6XW]
- (340) - Bright Blue [Trim Codes D6B5, C6B5]
- (452) - Green [Trim Codes D6F7, C6F7]
- (664) - Brown [Trim Codes D6T7, C6T7]
- (666) - Ember Gold [Trim Codes D6Y3, C6Y3]

***R/T & 500 Trim Codes - D6X9, D6XA, D6XW, D6B5, D6F7, D6T7, D6Y3
 ***Superbee Trim Codes - C6X9, C6XA, C6XW, C6B5, C6F7, C6T7, C6Y3

1971 CHARGER R/T, CHARGER 500 & SUPERBEE "CLOTH STYLE"

This Legendary product features as-original Salt & Pepper cloth inserts with Coachman grain skirts.

(C) COLOR CODES:

- (811) - Black & White Salt & Pepper Cloth (810) / Black (100) [Trim Codes D5X9, C5X9]
- (824) - Black & Green Salt & Pepper Cloth (820) / Dark Green (452) [Trim Codes D5F7, C5F7]
- (825) - Black & Orange Salt & Pepper Cloth (814) / Black (100) [Trim Codes D5XV, C5XV]

***R/T & 500 Trim Codes - D5X9, D5F7, D5XV
 ***Superbee Trim Codes - C5X9, C5F7, C5XV



Front BucketsAA71CRXC010(C)
 811.....\$1331/pr. (L4)
 824, 825.....\$1339/pr. (L1)
 *Molded foam is available for this model. See the "Molded Foam" section in this catalog.

Center Cushion/Armrest.....CR71CRWXH13(C)
 100, 452.....\$99/ea.

Rear Bench.....AA71CRXC040(C)
 811.....\$1174/pr. (L4)
 824, 825.....\$1178/pr. (L1)

1971 CHARGER SE "LEATHER STYLE"

This Legendary product features as-original Leather inserts with buttons & Belmont grain skirts.

(C) COLOR CODES:

- (100) - Black [Trim Code CRX9]
- (140) - Gunmetal [Trim Code CRXA]
- (664) - Brown [Trim Code CRT7]



Front BucketsAA71CXL0010(C)
 100.....\$1029/ea. (L3)
 140, 664.....\$1249/ea. (L3)
 *Molded foam is available for this model. See the "Molded Foam" section in this catalog.

Center Cushion/Armrest.....CR71CXL0013(C)
 (All colors).....\$99/ea.

Rear Bench.....AA71CXL0040(C)
 (All colors).....\$375/ea.

1971 CHARGER SE "CLOTH STYLE"

This Legendary product features as-original Ribbed cloth inserts with Belmont grain skirts.

(C) COLOR CODES:

- (841) - Black Ribbed Cloth (840) / Black (100) [Trim Code E5X9]
- (843) - Blue Ribbed Cloth (842) / Bright Blue (340) [Trim Code E5B5]
- (845) - Green Ribbed Cloth (844) / Dark Green (434) [Trim Code E5F7]
- (847) - Ember Gold Ribbed Cloth (846) / Ember Gold (666) [Trim Code E5Y3]

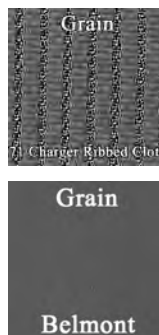

Front BucketsAA71CXCR010(C)
 (All colors).....\$1011/pr. (L1)
 *Molded foam is available for this model. See the "Molded Foam" section in this catalog.

Center Cushion/Armrest.....CR71CXL0013(C)
 (All colors).....\$99/ea.

Rear Bench.....AA71CXCR048(C)
 (All colors).....\$813/ea. (L1)

1972-73 CHARGER & CHARGER SE

This Legendary product features as-original *Shallow Elk grain inserts with buttons & Cologne grain skirts.*

Front Buckets	AA72CRX0010(C)
100, 200, 340, 444, 666	\$547/pr.
253, 449	\$909/pr. (L1)
352	\$506/pr. (L4)
675	\$1285/pr. (L1)

*Molded foam is available for this model.

Center Cushion/Armrest	CR71CRWX013(C)
100, 200, 250, 340, 444, 666	\$ 99/ea.
672	\$238/ea. (L1)

Rear Bench	AA72CRX0040(C)
100, 200, 340, 444, 666	\$375/ea.
253, 449	\$743/pr. (L1)
352	\$357/ea. (L4)
675	\$1107/pr. (L1)

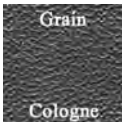

(C) COLOR CODES:

- (100) - Black [Trim Codes E6X9, H6X9] - 1972-1973
 - (200) - White [Trim Codes E6XW, H6XW] - 1972-1973
 - (253) - Metallic Parchment (252) / Parchment (250) [Trim Codes E6L3, H6L3] - 1973 only
 - (340) - Bright Blue [Trim Code E6B5] - 1972 only
 - (352) - Bright Blue (341) / Bright Blue (340) [Trim Codes E6B5, H6B5] - 1973 only
 - (444) - Dark Green [Trim Code E6F6] - 1972 only
 - (449) - Metallic Green (448) / Dark Green (444) [Trim Codes E6F6, H6F6] - 1973 only
 - (666) - Ember Gold [Trim Code E6Y3] - 1972 only
 - (675) - Metallic Bronze (674) / Honey Gold (672) [Trim Codes E6Y4, H6Y4] - 1973 only
- ***1972 Charger & SE Trim Codes - E6X9, E6XW, E6B5, E6F6, E6Y3
 ***1973 Charger Trim Codes - H6X9, H6XW, H6L3, H6B5, H6F6, H6Y4
 ***1973 Charger SE Trim Codes - E6X9, E6XW, E6L3, E6B5, E6F6, E6Y4

1973 CHARGER & CHARGER SE "CLOTH STYLE"

This Legendary product features as-original *Salt & Pepper cloth inserts with buttons & Cologne grain skirts.*

(C) COLOR CODES:

(811) - Black & White Salt & Pepper Cloth (810) / Black (100) [Trim Codes E5X9, H5X9]

***Charger SE Trim Code - E5X9

***Charger Trim Code - H5X9

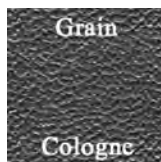

Front Buckets	AA73CXC0010(C)
811	\$960/pr. (L4)

*Molded foam is available for this model. See the "Molded Foam" section in this catalog.

Center Cushion/Armrest	CR71CRWX013(C)
100	\$99/ea.

Rear Bench	AA73CXC0040(C)
811	\$809/ea. (L4)

1974 CHARGER & CHARGER SE "CLOTH STYLE"

This Legendary product features as-original *Aztec cloth inserts with buttons & Oxford grain skirts.*

(C) COLOR CODES:

(951) - Black & Gold Cloth (950) / White (200) [Trim Code E5YW]



Front Buckets	AA74CXC0010(C)
951	\$1007/pr. (L1)

*Molded foam is available for this model. See the "Molded Foam" section in this catalog.

Center Cushion/Armrest	CR71CRWXF13(C)
200	\$99/ea.

Rear Bench	AA74CXC0040(C)
951	\$813/ea. (L1)

1974 CHARGER & CHARGER SE

This Legendary product features as-original *Shallow Elk grain inserts with buttons & Oxford grain skirts.*

(C) COLOR CODES:

- (100) - Black [Trim Codes D6X9, H6X9]
- (200) - White [Trim Codes D6XW, H6XW]
- (360) - Lagoon Blue [Trim Codes D6B6, H6B6]
- (450) - Jade Green [Trim Codes D6G6, H6G6]
- (680) - Ember Gold [Trim Codes D6Y3, H6Y3]

***Charger Trim Codes - D6X9, D6XW, D6B6, D6G6, D6Y3

***Charger SE Trim Codes - H6X9, H6XW, H6B6, H6G6, H6Y3



Front Buckets	AA74CRX0010(C)
100, 200, 360, 450	\$547/pr.
680	\$1285/pr. (L1)

*Molded foam is available for this model. See the "Molded Foam" section in this catalog.

Center Cushion/Armrest	CR71CRWXF13(C)
100, 200, 360, 450	\$ 99/ea.
680	\$238/ea. (L1)

Rear Bench	AA74CRX0040(C)
100, 200, 360, 450	\$375/ea.
680	\$1107/ea. (L1)



1970 CHARGER

This Legendary product features as-original Diamond Basketweave inserts with Krinkle grain skirts.

(C) COLOR CODES:

- (100) - Black [Not a factory option]
*Black was not originally offered, but may be purchased as a special order. Available only as a prepaid, non-refundable and non-returnable order.
- (154) - Charcoal [Trim Code C2XA]
- (200) - White [Trim Code C2XW]
- (338) - Bright Blue [Trim Code C2B5]
- (434) - Dark Green [Trim Code C2F8]
- (540) - Burnt Orange [Trim Code C2K4]
- (656) - Brown [Trim Code C2T5]



- Front Split Bench..... AA70CX00020(C)
(All colors)..... \$547/ea.
- Rear Bench..... AA70CX00048(C)
(All colors)..... \$427/ea.

1971 CHARGER "COUPE"

This Legendary product features as-original El Paso grain inserts with Coachman grain skirts.

(C) COLOR CODES:

- (168) - Charcoal (156) / Black (100) [Trim Code E2X9]
- (340) - Bright Blue [Trim Code E2B5]
- (665) - Tan (668) / Brown (664) [Trim Code E2T7]

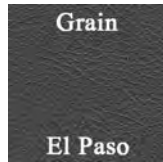

- Front Split Bench..... AA71CRXS020(C)
(All colors)..... \$547/ea.
- Rear Bench..... AA71CRXS080(C)
(All colors)..... \$384/ea.

1971 CHARGER & SUPERBEE "HARDTOP"

This Legendary product features as-original Derma grain inserts with Coachman grain skirts.

(C) COLOR CODES:

- (100) - Black [Trim Code C2X9]
- (200) - White [Trim Code C2XW]
- (340) - Bright Blue [Trim Code C2B5]
- (452) - Dark Green [Trim Code C2F7]
- (664) - Brown [Trim Code C2T7]
- (666) - Ember Gold [Trim Code C2Y3]



- Front Split Bench..... AA71CXD0020(C)
(All colors)..... \$547/ea.
*Metal emblems not included.
- Rear Bench..... AA71CXD0080(C)
(All colors)..... \$384/ea.
*Metal emblems not included.

1971 CHARGER 500 "CLOTH STYLE"

This Legendary product features as-original Salt & Pepper cloth inserts with Coachman grain skirts.

(C) COLOR CODES:

- (811) - Black & White Salt & Pepper Cloth (810) / Black (100) [Trim Code C3X9]
- (821) - Black & Blue Salt & Pepper Cloth (818) / Bright Blue (340) [Trim Code C3B5]
- (824) - Black & Green Salt & Pepper Cloth (820) / Dark Green (452) [Trim Code C3F7]



- Front Split Bench with Center Armrest..... AA71CXC0030(C)
811..... \$1439/ea. (L4)
821, 824..... \$1446/ea. (L1)
- Rear Bench..... AA71CRXC040(C)
811..... \$1174/ea. (L4)
821, 824..... \$1178/ea. (L1)

1971 CHARGER SE "CLOTH STYLE"

This Legendary product features as-original Ribbed cloth inserts with Belmont grain skirts.

(C) COLOR CODES:

- (841) - Black Ribbed Cloth (840) / Black (100) [Trim Code D3X9]
- (843) - Blue Ribbed Cloth (842) / Bright Blue (340) [Trim Code D3B5]
- (845) - Green Ribbed Cloth (844) / Dark Green (434) [Trim Code D3F7]
- (847) - Ember Gold Ribbed Cloth (846) / Ember Gold (666) [Trim Code D3Y3]

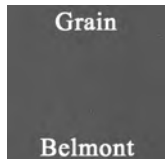
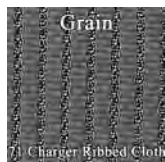

Front Split Bench with Center Armrest **AA71CXCR030(C)**
(All colors)..... \$1034/ea. (L1)

Rear Bench..... **AA71CXCR048(C)**
(All colors)..... \$813/ea. (L1)

1972 CHARGER "COUPE"

This Legendary product features as-original Shallow Elk grain inserts with Coachman grain skirts.

(C) COLOR CODES:

- (168) - Charcoal (156) / Black (100) [Trim Code B2X9]
- (340) - Bright Blue [Trim Code B2B5]
- (445) - Light Green (432) / Dark Green (444) [Trim Code B2F6]



Front Split Bench..... **AA72CRXS020(C)**
(All colors)..... \$547/ea.

Rear Bench..... **AA72CRXS080(C)**
(All colors)..... \$375/ea.

1972 CHARGER & CHARGER SE

This Legendary product features as-original Ranger grain inserts with Cologne grain skirts.

(C) COLOR CODES:

- (100) - Black [Trim Code S2X9]
- (200) - White [Trim Code S2XW]
- (340) - Bright Blue [Trim Code S2B5]
- (444) - Dark Green [Trim Code S2F6]
- (662) - Brown [Trim Code S2T5]
- (666) - Ember Gold [Trim Code S2Y3]

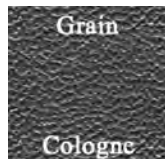

Front Split Bench **AA72CXD0020(C)**
(All colors)..... \$547/ea.

Rear Bench..... **AA72CXD0080(C)**
(All colors)..... \$384/ea.

1973 CHARGER SE

This Legendary product features as-original Shallow Elk grain inserts with Coachman grain skirts.

(C) COLOR CODES:

- (100) - Black [Trim Code H4X9]
- (253) - Metallic Parchment (252) / Parchment (250) [Trim Code H4L3]
- (352) - Bright Blue (341) / Bright Blue (340) [Trim Code H4B5]
- (449) - Metallic Green (448) / Dark Green (444) [Trim Code H4F6]
- (675) - Metallic Bronze (674) / Honey Gold (672) [Trim Code H4Y4]



Front Split Bench with Center Armrest **AA73CRWX030(C)**
100..... \$569/ea.
253, 449..... \$978/ea. (L1)
352..... \$552/ea. (L4)
675..... \$1413/ea. (L1)

Rear Bench..... **AA73CRX0080(C)**
100..... \$384/ea.
253, 449..... \$754/ea. (L1)
352..... \$374/ea. (L4)
675..... \$1124/ea. (L1)



1973 CHARGER "HARDTOP"

This Legendary product features as-original
Shallow Elk grain inserts with Coachman grain skirts.

(C) COLOR CODES:

- (100) - Black [Trim Code C2X9]
- (253) - Metallic Parchment (252) / Parchment (250) [Trim Code C2L3]
- (352) - Bright Blue (341) / Bright Blue (340) [Trim Code C2B5]
- (449) - Metallic Green (448) / Dark Green (444) [Trim Code C2F6]
- (675) - Metallic Bronze (674) / Honey Gold (672) [Trim Code C2Y4]

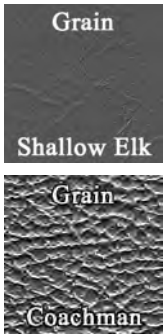

Front Split Bench.....	AA73CRXD020(C)
100.....	\$547/ea.
253, 449.....	\$909/ea. (L1)
352.....	\$531/ea. (L4)
675.....	\$1392/ea. (L1)

*Metal emblems not included.

Rear Bench.....	AA73CRXD080(C)
100.....	\$384/ea.
253, 449.....	\$754/ea. (L1)
352.....	\$374/ea. (L4)
675.....	\$1124/ea. (L1)

*Metal emblems not included.

1973 CHARGER SE "CLOTH STYLE"

This Legendary product features as-original
Cloth inserts with buttons & Coachman grain skirts.

(C) COLOR CODES:

- (927) - Black Cloth (920) / Black (100) [Trim Code V3X9]
- (928) - Dark Green Cloth (921) / Dark Green (444) [Trim Code V3F6]
- (931) - Bright Blue Cloth (923) / Bright Blue (340) [Trim Code V3B5]
- (933) - Honey Gold Cloth (925) / Honey Gold (672) [Trim Code V3Y4]



Front Split Bench with Center Armrest (all cloth c.a.r.).....	AA73CXC0030(C)
Front Split Bench with Center Armrest (cloth & vinyl c.a.r.).....	AA73CXC030(C)
927, 928, 931.....	\$986/ea. (L1)
933.....	\$1363/ea. (L1)

Rear Bench.....	AA73CXC0080(C)
927, 928, 931.....	\$825/ea. (L1)
933.....	\$1177/ea. (L1)

1974 CHARGER SE

This Legendary product features as-original
Shallow Elk grain inserts with Oxford grain skirts.

(C) COLOR CODES:

- (100) - Black [Trim Code M4X9]
- (267) - Metallic Parchment (266) / Parchment (264) [Trim Code M4L3]
- (360) - Lagoon Blue [Trim Code M4B6]
- (450) - Jade Green [Trim Code M4G6]
- (680) - Ember Gold [Trim Code M4Y3]

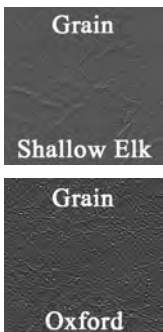

Front Split Bench with Center Armrest.....	AA74CRWX030(C)
100, 360, 450.....	\$569/ea.
267, 680.....	\$1413/ea. (L1)

Rear Bench.....	AA74CRX0080(C)
100, 360, 450.....	\$384/ea.
267, 680.....	\$1235/ea. (L1)

1974 CHARGER "HARDTOP"

This Legendary product features as-original
Richmond grain inserts with Oxford grain skirts.

(C) COLOR CODES:

- (100) - Black [Trim Code S2X9]
- (264) - Parchment [Trim Code S2L3]
- (360) - Lagoon Blue [Trim Code S2B6]
- (450) - Jade Green [Trim Code S2G6]
- (680) - Ember Gold [Trim Code S2Y3]

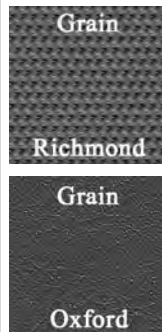

Front Split Bench.....	AA74CX00020(C)
100, 360, 450.....	\$547/ea.
264.....	\$1339/ea. (L4)
680.....	\$1339/ea. (L1)

*Metal emblems not included.

Rear Bench.....	AA74CX00080(C)
100, 360, 450.....	\$384/ea.
264.....	\$1177/ea. (L4)
680.....	\$1177/ea. (L1)

*Metal emblems not included.

1974 CHARGER SE "CLOTH STYLE"

This Legendary product features as-original Cloth inserts with Oxford grain skirts.

(C) COLOR CODES:

- (927) - Black Cloth (920) / Black (100) [Trim Code V3X9]
- (929) - Jade Green Cloth (922) / Jade Green (450) [Trim Code V3G6]
- (932) - Blue Cloth (924) / Lagoon Blue (360) [Trim Code V3B6]
- (935) - Gold Cloth (926) / Ember Gold (680) [Trim Code V3Y3]



- Front Split Bench with Center Armrest (all cloth c.a.r.) **AA74CRXC030(C)**
- Front Split Bench with Center Armrest (cloth & vinyl c.a.r.) **AA74CRXC030(C)**
- 927, 929, 932 \$986/ea. (L1)
- 935 \$1358/ea. (L1)

- Rear Bench **AA74CRXC080(C)**
- 927, 929, 932 \$825/ea. (L1)
- 935 \$117/ea. (L1)

1966 CORONET 500

This Legendary product features as-original Cologne grain inserts with Cologne grain skirts.

(C) COLOR CODES:

- (100) - Black [Trim Code P4X]
- (202) - Pearl White [Trim Code P4W]
- (320) - Navy [Trim Code P4D]
- (420) - Citron [Trim Code P4Y]
- (520) - Red [Trim Code P4R]
- (617) - Ginger (616) / Gold (614) [Trim Code P4T]

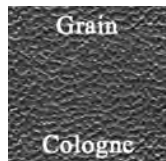

- Front Buckets **AA66CW0010(C)**
- (All colors) \$542/pr.
- *Please specify cordwell size. Small will be used unless specified at time of order.*
- *Molded foam is available for this model. Please see the "Molded Foam" section in this catalog.*
- Front Bucket Seatback Panels **SK66CW0018(C)**
- (Pre-sewn vinyl and carpet lower seatback panel kit)
- (All colors) \$92/ea.
- *Please refer to carpet color selection at time of order.*
- Center Cushion/Armrest **CR66CRWX013(C)**
- (All colors) \$99/ea.
- Hardtop Rear Bench **AA66CW00040(C)**
- Convertible Rear Bench **AA66CW00050(C)**
- (All colors) \$375/ea.
- Convertible Rear Seat Bottom Panels **SK66CRW0012(C)**
- (Pre-cut/pre-sewn carpeted lower trim panels)
- (All colors) \$75/ea.
- *Please refer to carpet color selection at time of order.*

1965 CORONET 500

This Legendary product features as-original heat sealed Bison grain inserts with Cologne or Pembroke grain accent & Bison grain skirts

(C) COLOR CODES:

- (100) - Black [Trim Code P4X]
- (202) - Pearl White [Trim Code P4Y]
- (317) - Blue (314) with Navy Blue (336) Collar [Trim Code P4B]
- (419) - Turquoise (416) with Dark Green (418) Collar [Trim Code P4Q]
- (525) - Red (520) with SRM Dark Maroon (524) Collar [Trim Code P4R]
- (613) - Fawn Tan (610) with Dark Brown (612) Collar [Trim Code P4T]

(C) SEATBACK PANEL COLOR CODES:

- (100) - Black
- (202) - Pearl White
- (314) - Blue
- (416) - Turquoise
- (520) - Red
- (610) - Fawn Tan

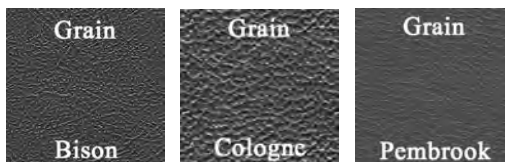

- Front Buckets **AA65CW00010(C)**
- 100,202,317,419,316 \$690/pr.
- 525 \$914/pr. (L1)
- *Please specify carpet color of stretch panel at time of order.*
- *Molded foam is available for this model. See the "Molded Foam" section in this catalog.*
- Front Bucket Seatback Panels **SK65CW00018(C)**
- (Pre-sewn vinyl and carpet panels with new boards)
- 100, 202, 314, 416, 520, 610 \$194/pr.
- *Please refer to carpet color selection at time of order.*
- Hardtop Rear Bench **AA65CW00040(C)**
- Convertible Rear Bench **AA65CW00050(C)**
- 100,202,317,419,316 \$641/ea.
- 525 \$881/ea. (L1)
- Convertible Rear Bench Back Panel **SK65CW00019(C)**
- 100, 202, 314, 416, 520, 610 \$75/ea.



1967 CORONET 500 & CORONET R/T

This Legendary product features as-original Bambino grain inserts with Cologne grain skirts.

(C) COLOR CODES:

- (100) - Black [Trim Code P6X]
- (202) - Pearl White [Trim Code P6W]
- (320) - Navy [Trim Code P6B]
- (520) - Red [Trim Code P6R]
- (620) - Copper [Trim Code P6K]
- (630) - Gold [Trim Code P6E]

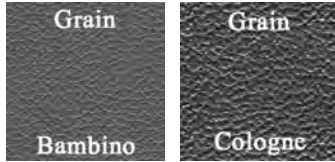

- Front Buckets **AA67CW0010(C)**
(All colors)..... \$542/pr.
**Please specify cordwelt size. Small will be used unless specified at time of order.
Molded foam is available for this model. See the "Molded Foam" section in this catalog.
- Front Bucket Seatback Panels **SK66CW0018(C)**
(Pre-sewn vinyl and carpet lower seatback panel kit)
(All colors)..... \$92/pr.
**Refer to carpet color selection at time of order.*
- Center Cushion/Armrest **CR66CRWX013(C)**
(All colors)..... \$99/ea.
- Hardtop Rear Bench **AA67CW00040(C)**
Convertible Rear Bench **AA67CW00050(C)**
(All colors)..... \$375/ea.
- Convertible Rear Seat Bottom Panels **SK66CRW0012(C)**
(Pre-cut/pre-sewn carpeted lower trim panels)
(All colors)..... \$75/ea.
**Refer to carpet color selection at time of order.*

1968 CORONET 500 & CORONET R/T

This Legendary product features as-original Ascot grain inserts with Cologne grain skirts.

- Front Buckets **AA68CW00010(C)**
(All colors)..... \$547/pr.
**Molded foam is available for this model.*

- Front Bucket Seatback Panels **SK68AB00018(C)**
(New boards wrapped in vinyl with mounting hardware attached as original.)
100, 202, 330, 430, 526, 630..... \$167/pr.

- Center Cushion/Armrest
(with map pocket) **CR68CW00013(C)**
(without map pocket) **CR68CW0013N(C)**
(All colors)..... \$99/ea.

- Hardtop Rear Bench **AA68CW00040(C)**
Convertible Rear Bench **AA68CW00056(C)**
(All colors)..... \$384/ea.

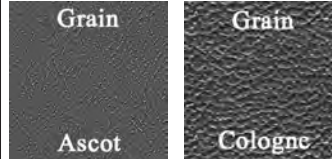

(C) COLOR CODES:

- (100) - Black [Trim Codes P6X, S6X]
- (202) - Pearl White [Trim Codes P6W, P6C, P6D, P6V, S6W, S6C, S6D, S6V]
**P6W, S6W - Pearl White w/ Black Carpet
*P6C, S6C - Pearl White w/ Blue Carpet
*P6D, S6D - Pearl White w/ Green Carpet
P6V, S6V - Pearl White w/ Red Carpet
- (351) - Light Blue (332) / Dark Blue (330) [Trim Codes P6B, S6B]
- (430) - Dark Green [Trim Codes P6F, S6F]
- (533) - Red (520) / Maroon (526) [Trim Codes P6R, S6R]
- (630) - Gold [Trim Codes P6N, S6N]

***Coronet 500 Trim Codes - P6X, P6W, P6B, P6F, P6R, P6N
***Coronet R/T Trim Codes - S6X, S6W, S6B, S6F, S6R, S6N

1968 CORONET 500 & CORONET R/T "RALLYE SEAT"

This Legendary product features as-original Ascot grain inserts with Cologne grain skirts.

(C) COLOR CODES:

- (100) - Black
- (202) - Pearl White
- (351) - Light Blue (332) / Dark Blue (330)
- (430) - Dark Green
- (533) - Red (520) / Maroon (526)
- (630) - Gold

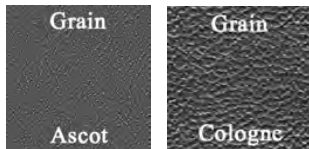

- Front Buckets **RS68CW00010(C)** 
(All colors)..... \$925/pr.
**Kit consists of: (1) pair Rallye Bucket Seat Upholstery, (1) set Rallye Bucket Seat Foam, (4) Front Seat Top Spring to Frame Hold Back Listing, (1 yd) Muslin, (30 ft) Listing Wire, (2 yds) Burlap, (9 ft) 2 inch Felt and (1) Dust Mask.*
- Front Bucket Seatback Panels **SK68AB00018(C)**
(New boards wrapped in vinyl with mounting hardware attached as original. Ready to install.)
100, 202, 330, 430, 526, 630..... \$167/pr.
- Center Cushion/Armrest
(with map pocket) **CR68CW00013(C)**
(without map pocket) **CR68CW0013N(C)**
(All colors)..... \$99/ea.
- Hardtop Rear Bench **AA68CW00040(C)**
Convertible Rear Bench **AA68CW00056(C)**
(All colors)..... \$384/ea.

1969 CORONET 500, CORONET R/T & SUPERBEE

This Legendary product features as-original El Paso grain inserts with Coachman grain skirts.

- Front Buckets **AA69CW00010(C)**
(All colors)..... \$547/pr.
**Metal emblems not included.
Molded foam is available for this model.

- Front Bucket Seatback Panels **SK68AB00018(C)**
(New boards wrapped in vinyl with mounting hardware attached as original.)
(All colors)..... \$167/pr.

- Center Cushion/Armrest
(with map pocket) **CR69CRWX013(C)**
(without map pocket) **CR69CRWX13N(C)**
(All colors)..... \$99/ea.

- Hardtop Rear Bench **AA69CW00040(C)**
Convertible Rear Bench **AA69CW00056(C)**
(All colors)..... \$384/ea.
**Metal emblems not included.*



(C) COLOR CODES:

- (100) - Black [Trim Codes P6X, M6X]
- (200) - White [Trim Codes P6W, P6C, P6F, P6V, M6W, M6C, M6F, M6V]
**P6W, S6W - Pearl White w/ Black Carpet
*P6C, S6C - Pearl White w/ Blue Carpet
*P6D, S6D - Pearl White w/ Green Carpet
P6V, S6V - Pearl White w/ Red Carpet
- (330) - Blue [Trim Codes P6D, M6B]
- (434) - Green [Trim Codes P6G, M6G]
- (528) - Red [Trim Codes P6R, M6R]
- (650) - Saddle [Trim Codes P6T, M6T]

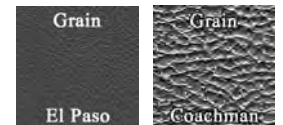

***Coronet 500 & R/T Trim Codes - P6X, P6W, P6C, P6F, P6V, P6D, P6G, P6R, P6T
***Superbee Trim Codes - M6X, M6W, M6C, M6F, M6V, M6B, M6G, M6R, M6T

1969 CORONET 500, CORONET R/T & SUPERBEE "RALLYE SEAT"

This Legendary product features as-original El Paso grain inserts with Coachman grain skirts.

(C) COLOR CODES:

- (100) - Black
- (200) - White
- (330) - Blue
- (434) - Green
- (528) - Red
- (650) - Saddle



PHOTO N/A
AT TIME OF
PRINTING

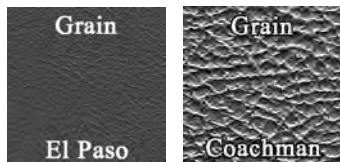

Front Buckets **RS69CW00010(C)** 
(All colors)..... \$925/pr.

*Metal emblems not included.

*Kit consists of: (1) pair Rallye Bucket Seat Upholstery, (1) set Rallye Bucket Seat Foam, (4) Front Seat Top Spring to Frame Hold Back Listing, (1 yd) Muslin, (30 ft) Listing Wire, (2 yds) Burlap, (9 ft) 2 inch Felt and (1) Dust Mask.

Front Bucket Seatback Panels **SK68AB00018(C)**
(New boards wrapped in vinyl with mounting hardware attached as original.)
(All colors)..... \$167/pr.

Center Cushion/Armrest
(with map pocket) **CR69CRWX013(C)**
(without map pocket) **CR69CRWX13N(C)**
(All colors)..... \$99/ea.

Hardtop Rear Bench **AA69CW00040(C)**
Convertible Rear Bench **AA69CW00056(C)**
(All colors)..... \$384/ea.

*Metal emblems not included.

1970 CORONET 500, CORONET R/T & SUPERBEE

This Legendary product features as-original Shallow Elk grain inserts with Coachman grain skirts.

Front Buckets **AA70CW00010(C)**
100, 200, 330, 434, 540, 656.....\$547/pr.
660.....\$1285/pr. (L1)

Center Cushion/Armrest
(with map pocket) **CR69CRWX013(C)**
(without map pocket) **CR69CRWX13N(C)**
100, 200, 330, 434, 540, 656.....\$ 99/ea.
660.....\$238/ea. (L1)

Hardtop Rear Bench..... **AA70CW00040(C)**
Convertible Rear Bench **AA70CW00056(C)**
100, 200, 330, 434, 540, 656.....\$375/ea.
660.....\$1107/ea. (L1)

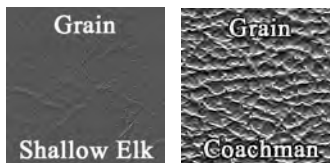

(C) COLOR CODES:

- (100) - Black [Trim Codes D6X9, M6X9]
- (200) - White [Trim Codes D6XW, M6XW]
- (330) - Blue [Trim Codes D6B7, M6B7]
- (434) - Green [Trim Codes D6F8, M6F8]
- (540) - Burnt Orange [Trim Codes D6K4, M6K4]
- (656) - Brown [Trim Codes D6T5, M6T5]
- (660) - Gold [Trim Codes D6XY, M6XY]

***Coronet 500 & R/T Trim Codes - D6X9, D6XW, D6B7, D6F8, D6K4, D6T5, D6XY
***Superbee Trim Codes - M6X9, M6XW, M6B7, M6F8, M6K4, M6T5, M6XY

1966 CORONET 440

This Legendary product features as-original Cirrus grain inserts with Cologne grain skirts.

(C) COLOR CODES:

- (151) - Dark Gray (110) / Black (100) [Trim Code H4X]
- (211) - Opal (210) / Pearl White (202) [Trim Code H4W]
- (323) - Dark Blue (336) / Navy (320) [Trim Code H4B]
- (523) - Dark Red (500) / Red (520) [Trim Code H4R]
- (617) - Ginger (616) / Gold (614) [Trim Code H4T]

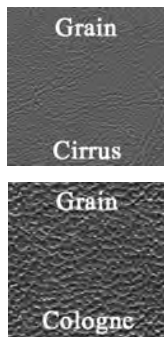

Front Split Bench **AA66CW00020(C)**
151, 211, 323, 325, 617.....\$547/ea.
523.....\$965/ea. (L1)

Hardtop Rear Bench **AA66CW00080(C)**
Convertible Rear Bench **AA66CW00060(C)**
151, 211, 323, 325, 617.....\$384/ea.
523.....\$825/ea. (L1)

*617 Ginger/Gold was not available in conv. model.

Convertible Rear Seat Bottom Panels **SK66CRW0012(C)**
(Pre-cut/pre-sewn carpeted lower trim panels)
(All colors).....\$75/ea.

*Please refer to carpet color selection at time of order.

1966 CORONET DELUXE "CLOTH STYLE"

This Legendary product features as-original Cloth inserts with Cologne grain skirts.

(C) COLOR CODES:

- (867) - Blue Cloth (874) / Navy (320) [Trim Code L1B]
- (868) - Turquoise Cloth (875) / Dark Turquoise (414) [Trim Code L1Q]
- (869) - Gold Cloth (876) / Gold (614) [Trim Code L1T]



Front Split Bench **AA66CWDC020(C)**
867, 868.....\$1041/ea. (L1)
869.....\$1339/ea. (L1)

2-Door Sedan Rear Bench **AA66CWDC080(C)**
867, 868.....\$825/ea. (L1)
869.....\$1177/ea. (L1)



1967 CORONET 440

This Legendary product features as-original Dorchester grain inserts with Cologne grain skirts & heat sealed top panels.

(C) COLOR CODES:

- (100) - Black [Trim Code H4X]
- (202) - Pearl White [Trim Code H4W]
- (327) - Navy (320) / Light Blue (318) [Trim Code H4B]
- (520) - Red [Trim Code H4R]
- (620) - Copper [Trim Code H4K]

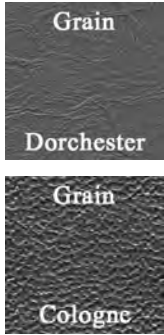

- Front Split Bench..... **AA67CW00020(C)**
(All colors)..... \$569/ea.
**Metal emblems not included.*
- Hardtop Rear Bench..... **AA67CW00080(C)**
- Convertible Rear Bench..... **AA67CW00060(C)**
(All colors)..... \$404/ea.
**Metal emblems not included.*
- Convertible Rear Seat Bottom Panels..... **SK66CRW0012(C)**
(Pre-cut/pre-sewn carpeted lower trim panels)
(All colors)..... \$75/ea.
**Please refer to carpet color selection at time of order.*

1968 CORONET 440 & SUPERBEE

This Legendary product features as-original Ascot grain inserts with Cologne grain skirts.

(C) COLOR CODES:

- (100) - Black [Trim Code H4X]
- (202) - Pearl White [Trim Codes H4W, H4C, H4D, H4V]
**H4W - Pearl White w/ Black Carpet*
**H4C - Pearl White w/ Blue Carpet*
**H4D - Pearl White w/ Green Carpet*
**H4V - Pearl White w/ Red Carpet*
- (359) - Dark Blue (330) / Light Blue (332) [Trim Code H4B]
- (431) - Dark Green (430) / Light Green (432) [Trim Code H4F]
- (529) - Maroon (526) / Red (520) [Trim Code H4R]



- Front Split Bench..... **AA68CW00028(C)**
100, 202, 359, 431, 529..... \$547/ea.
- Headrest Covers..... **HC68CLMRW14(C)**
100, 202, 332, 432, 520..... \$105/pr.
- Rear Bench..... **AA68CW00080(C)**
100, 202, 359, 431, 529..... \$384/ea.

1968 CORONET 500

This Legendary product features as-original Ascot grain inserts with Cologne grain skirts.

(C) COLOR CODES:

- (100) - Black [Trim Code P4X]
- (351) - Light Blue (332) / Dark Blue (330) [Trim Code P4B]
- (430) - Green [Trim Code P4F]
- (630) - Gold [Trim Code P4N]

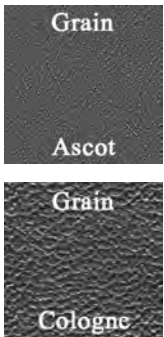

- Front Split Bench (Convertible only)..... **AA68CW00026(C)**
(All colors)..... \$547/ea.
- Headrest Covers..... **HC68CLMRW14(C)**
100, 332, 430, 630..... \$105/pr.
- Convertible Rear Bench..... **AA68CW00056(C)**
(All colors)..... \$384/ea.

1968 CORONET DELUXE

This Legendary product features as-original Reed grain inserts with Cologne grain skirts.

(C) COLOR CODES:

- (105) - Black (100) / Silver (102) [Trim Code B4S]
- (359) - Dark Blue (330) / Light Blue (332) [Trim Code B4B]
- (633) - Light Fawn (634) / Oyster (220) [Trim Code B4L]

(C) HEADREST COLOR CODES:

- (100) - Black
- (332) - Light Blue
- (634) - Light Fawn

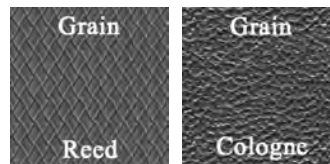

- Front Split Bench..... **AA68CRWE020(C)**
105, 359..... \$547/ea.
633..... \$953/ea. (L1)
- Headrest Covers..... **HC68CLMRW14(C)**
100, 330, 634..... \$105/pr.
- Rear Bench..... **AA68CRWE080(C)**
105, 359..... \$384/ea.
633..... \$801/ea. (L1)

1969 CORONET 440 & SUPERBEE

This Legendary product features as-original Coachman grain inserts with Coachman grain skirts.

(C) COLOR CODES:

- (100) - Black [Trim Code H2X]
- (200) - White [Trim Codes H2W, H2C, H2F]
- *H4W - White w/ Black Carpet
- *H2C - White w/ Blue Carpet
- *H2F - White w/ Green Carpet
- (359) - Dark Blue (330) / Light Blue (332) [Trim Code H2B]
- (437) - Dark Green (434) / Light Green (432) [Trim Code H2G]
- (528) - Red [Trim Code H2R]
- (650) - Saddle [Trim Code H2T]



- Front Split Bench..... **AA69CW00028(C)**
(All colors)..... \$569/ea.
- Headrest Covers..... **HC69CRW0014(C)**
100, 200, 330, 434, 528, 650..... \$105/pr.
- Rear Bench..... **AA69CW00080(C)**
(All colors)..... \$404/ea.

1969 CORONET DELUXE

This Legendary product features as-original Rosette grain inserts with Coachman grain skirts.

(C) COLOR CODES:

- (131) - Black (100) / Pewter (130) [Trim Code M2X]
- (359) - Dark Blue (330) / Light Blue (332) [Trim Code M2B]
- (651) - Bronze (640) / Saddle (650) [Trim Code M2T]

(C) HEADREST COLOR CODES:

- (100) - Black
- (332) - Light Metallic Blue
- (650) - Saddle

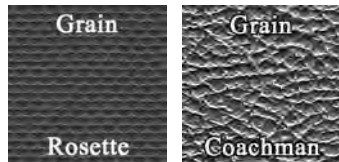

- Front Split Bench..... **AA69CRW0020(C)**
(All colors)..... \$547/ea.
- Headrest Covers..... **HC69CRW0014(C)**
(All colors)..... \$105/pr.
- Rear Bench..... **AA69CRW0080(C)**
(All colors)..... \$384/ea.

1969 CORONET 500

This Legendary product features as-original El Paso grain inserts with Coachman grain skirts.

(C) COLOR CODES:

- (100) - Black [Trim Code P2X]
- (200) - White [Trim Code P2W]
- (330) - Blue [Trim Code P2D]
- (434) - Green [Trim Code P2G]

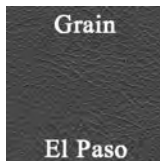

- Front Split Bench (Convertible only)..... **AA69CW00026(C)**
(All colors)..... \$547/ea.
**Metal emblems not included.*
- Headrest Covers..... **HC69CRW0014(C)**
(All colors)..... \$105/pr.
- Convertible Rear Bench **AA69CW00056(C)**
(All colors)..... \$384/ea.
**Metal emblems not included.*

1970 CORONET 440 & SUPERBEE

This Legendary product features as-original Vexon grain inserts with Coachman grain skirts.

(C) COLOR CODES:

- (100) - Black [Trim Code H2X9]
- (200) - White [Trim Code H2XW]
- (330) - Blue [Trim Code H2B7]
- (434) - Green [Trim Code H2F8]
- (540) - Burnt Orange [Trim Code H2K4]
- (656) - Brown [Trim Code H2T5]



- Front Split Bench..... **AA70CW00028(C)**
(All colors)..... \$547/ea.
- Rear Bench..... **AA70CW00080(C)**
(All colors)..... \$384/ea.



1970 CORONET 500

This Legendary product features as-original Shallow Elk grain inserts with Coachman grain skirts.

(C) COLOR CODES:

- (100) - Black [Trim Code D4X9]
- (200) - White [Trim Code D4XW]
- (330) - Blue [Trim Code D4B7]
- (434) - Green [Trim Code D4F8]
- (540) - Burnt Orange [Trim Code D4K4]
- (656) - Brown [Trim Code D4T5]

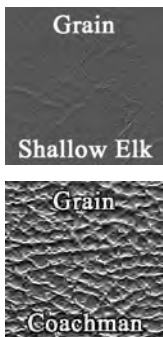

- Front Split Bench with Center Armrest **AA70CW00030(C)**
(All colors)..... \$569/ea.
- Convertible Rear Bench **AA70CW00056(C)**
(All colors)..... \$375/ea.

1963 POLARA 500

This Legendary product features as-original Bison grain inserts with Bison grain accent & Bison grain skirts.

(C) COLOR CODES:

- (113) - Black (100) / White (204) [Trim Code 656]
- (207) - Taupe (206) / White (204) [Trim Code 653]
- (303) - Blue (302) / White (204) [Trim Code 651]
- (407) - Turquoise (406) / White (204) [Trim Code 658]
- (514) - Crimson Red (510) / White (204) [Trim Code 655]

(C) SEATBACK PANEL COLOR CODES:

- (204) - White

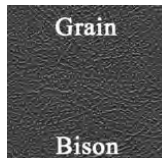

- Front Buckets **AA63CP00010(C)**
(All colors)..... \$675/pr.
**Please specify carpet color of stretch panel at time of order.*
**Molded foam is available for this model. See the "Molded Foam" section in this catalog.*
- Front Bucket Seatback Panels **SK63CFP0018(C)**
(Pre-sewn vinyl & carpet panels with new boards)
204..... \$194/pr.
**Please specify carpet color art time or order.*
- Hardtop Rear Bench **AA63CP00040(C)**
- Convertible Rear Bench **AA63CP00050(C)**
(All colors)..... \$627/ea.

1964 POLARA 500

This Legendary product features as-original Bison grain inserts with Bison grain skirts.

- Front Buckets **AA64CP00010(C)**
101, 503, 611..... \$675/pr.
311, 417..... \$901/pr.
413..... \$1305/pr. (L1)
**Specify silver tinsel or color of vinyl cordwelt around seat and back panel inserts at time of order.*
**Specify carpet color of stretch panel at time of order.*
**Molded foam is available for this model. Please see the "Molded Foam" section in this catalog.*

- Front Bucket Seatback Panels **SK64CP00018(C)**
(Pre-sewn vinyl with new boards)
101, 314, 416, 510, 610..... \$184/pr.
410..... \$335/pr. (L1)
- Hardtop Rear Bench **AA64CP00040(C)**
- Convertible Rear Bench **AA64CP00050(C)**
101, 503, 610..... \$627/ea.
311, 417..... \$853/ea.
413..... \$1155/ea. (L1)

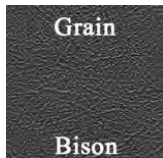

(C) COLOR CODES:

- (101) - Black with Silver Tinsel welt [Trim Code P4X]
- (311) - Blue (314) w/ Powder Blue (310) Accent [Trim Code P4B]
- (413) - Olive Gold (410) w/ Pearl White (202) Accent [Trim Code P4Y]
- (417) - Turquoise (416) w/ Light Turquoise (412) Accent [Trim Code P4Q]
- (503) - Red (510) w/ Pearl White (202) Accent & Silver Tinsel welt [Trim Code P4R]
- (611) - Fawn Tan (610) w/ Pearl White (202) Accent [Trim Code P4T]

1965 POLARA 500

This Legendary product features as-original Cologne grain inserts with Bison grain skirts.

(C) COLOR CODES:

- (100) - Black [Trim Code L9X]
- (325) - Dark Blue (322) / Light Blue (314) [Trim Code L9B]
- (520) - Red [Trim Code L9R]

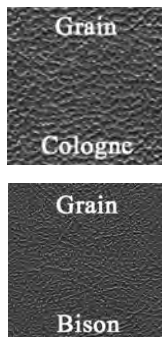

- Front Buckets **AA65CP00010(C)**
(All colors)..... \$675/ea.
**Please specify carpet color of stretch panel at time of order.*
**Molded foam is available for this model. See the "Molded Foam" section in this catalog.*
- Front Bucket Seatback Panels **SK65CP00018(C)**
(Pre-sewn vinyl & carpet panels with new boards)
100, 314, 520..... \$194/pr.
**Please specify carpet color art time or order.*
- Hardtop Rear Bench **AA65CP00048(C)**
(All colors)..... \$615/ea.

1964 POLARA

This Legendary product features as-original Bison grain inserts with heat sealed chrome emblems & Bison grain skirts.

(C) COLOR CODES:

- (100) - Black [Trim Code H4X]
- (314) - Blue [Trim Code H4B]
- (410) - Olive Gold [Trim Code H4Y]
- (416) - Turquoise [Trim Code H4Q]
- (510) - Crimson Red [Trim Code H4R]
- (610) - Fawn Tan [Trim Code H4T]

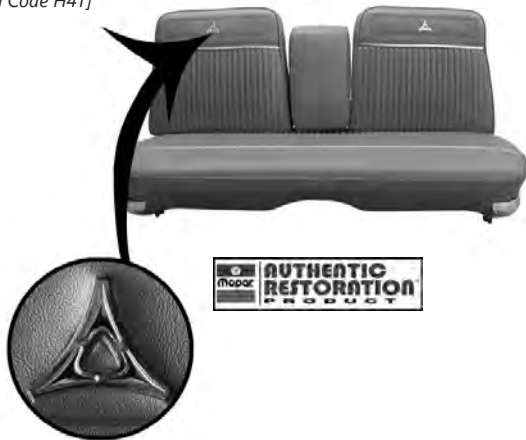
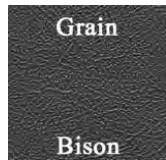

Front Split Bench with Center Armrest	AA64CP00030(C)
100, 314, 416, 510, 610	\$803/ea.
410	\$1622/ea. (L1)
Hardtop Rear Bench.....	AA64CP00080(C)
Convertible Rear Bench	AA64CP00060(C)
100, 314, 416, 510, 610	\$701/ea.
410	\$1406/ea. (L1)

1964 DODGE 440

This Legendary product features as-original Cloth inserts with Bison grain skirts.

(C) COLOR CODES:

- (399) - Blue Cloth (398) / Blue (314) [Trim Code M1B]
- (489) - Gold Cloth (488) / Olive Gold (410) [Trim Code M1Y]
- (499) - Turquoise Cloth (498) / Turquoise (416) [Trim Code M1Q]
- (589) - Red Cloth (588) / Crimson Red (510) [Trim Code M1R]
- (692) - Fawn Cloth (691) / Fawn Tan (610) [Trim Code M1T]



Front Bench.....	AA64CD4C020(C)
399, 499, 589, 692	\$1062/ea.
489	\$1348/ea.
Hardtop Rear Bench.....	AA64CD4C080(C)
399, 499, 589, 692	\$839/ea.
489	\$1128/ea.

1963 SPORT FURY

This Legendary product features as-original Pinpoint grain inserts & heat sealed center accent strip with chrome emblem with Bison grain skirts.

(C) COLOR CODES:

- (117) - Black (100) with Copper (604) Accent [Trim Code 459]
- (305) - Blue (302) with Light Blue (304) Accent [Trim Code 451]
- (513) - Crimson Red (510) with Dark White (204) Accent [Trim Code 455]

(C) SEATBACK PANEL COLOR CODES:

- (100) - Black
- (302) - Blue
- (510) - Crimson Red

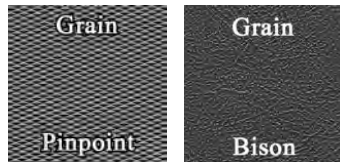

Front Buckets	AA63CF00010(C)
305, 513	\$710/pr.
117	\$902/pr. (L1)
<i>*Please specify carpet color of stretch panel at time of order.</i>	
<i>*Molded foam is available for this model. Please see the "Molded Foam" section in this catalog.</i>	
Front Bucket Seatback Panels	SK63CFP0018(C)
<i>(Pre-sewn vinyl and carpet panels with new boards)</i>	
100, 302, 510	\$194/pr.
<i>*Please refer to carpet color selection at time of order.</i>	
Hardtop Rear Bench.....	AA63CF00040(C)
Convertible Rear Bench	AA63CF00050(C)
305, 513	\$658/ea.
117	\$841/ea. (L1)

1964 SPORT FURY

This Legendary product features as-original Bison grain inserts with heat sealed upper insert with Bison grain skirts.

Front Buckets	AA64CF00010(C)
101, 503	\$675/pr.
319, 417, 609	\$894/pr. (L1)

**Please specify silver tinsel or color of vinyl cordwelt around seat and back panel inserts at time of order.*
**Please specify carpet color of stretch panel at time of order.*
**Molded foam is available for this model. See the "Molded Foam" section in this catalog.*

Front Bucket Seatback Panels	SK64CF00018(C)
<i>(Pre-sewn vinyl and carpet panels with new boards)</i>	
100, 314, 416, 510, 606	\$194/pr.
<i>*Please refer to carpet color selection at time of order.</i>	

Hardtop Rear Bench.....	AA64CF00040(C)
Convertible Rear Bench	AA64CF00050(C)
101, 503	\$627/ea.
319, 417, 609	\$835/ea. (L1)

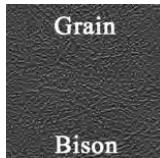

(C) COLOR CODES:

- (101) - Black with Silver Tinsel welt [Trim Code P4X]
- (319) - Blue (314) w/ Powder Blue (310) Accent & Silver Tinsel welt [Trim Code P4B]
- (417) - Turquoise (416) w/ Light Turquoise (412) Accent & Silver Tinsel welt [Trim Code P4Q]
- (503) - Red (510) w/ Pearl White (202) Accent & Silver Tinsel welt [Trim Code P4R]
- (609) - Copper (606) w/ Rosewood (506) Accent [Trim Code P4U]



1965 SPORT FURY

This Legendary product features as-original heat sealed Cologne grain inserts with chrome accent band & Bison grain skirts.

(C) COLOR CODES:

- (100) - Black [Trim Code P4X]
- (119) - Copper (602) / Black (100) [Trim Code P4U]
- (320) - Navy [Trim Code P4B]
- (414) - Turquoise [Trim Code P4Q]
- (520) - Red [Trim Code P4R]
- (614) - Gold [Trim Code P4Y]

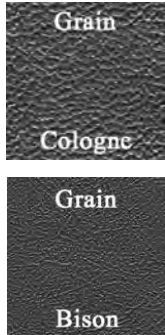

Front Buckets	AA65CF00010(C)
100, 320, 414, 520, 614	\$706/pr.
119	\$1044/pr. (L1)
*Please specify carpet color of stretch panel at time of order.	
*Molded foam is available for this model. See the "Molded Foam" section in this catalog.	
Front Bucket Seatback Panels	SK65CF00018(C)
<i>(Pre-sewn vinyl and carpet panels with new boards)</i>	
100, 320, 414, 520, 614	\$194/pr.
*Please refer to carpet color selection to specify carpet color at time of order.	
Power Seat Rail Carpet Kit.....	SK65CFM0020(C)
(All colors)	\$87/ea.
*Please refer to carpet color selection at time of order.	
Hardtop Rear Bench.....	AA65CF00040(C)
Convertible Rear Bench	AA65CF00050(C)
100, 320, 414, 520, 614	\$652/ea.
119	\$978/ea. (L1)
Rear Speaker Cover with Grommet	SC65CFMP050(C)
(All Colors)	\$93/ea.
Convertible Rear Bench Back Panel	SK64CFMP012
(Board Only)	\$50/ea.
.....	SK64CFMP012(C)
(All Colors)	\$77/ea.

1966 SPORT FURY

This Legendary product features as-original heat sealed Cologne grain inserts with Cologne grain skirts and chrome accent band.

(C) COLOR CODES:

- (100) - Black [Trim Code P4X]
- (318) - Blue [Trim Code P4B]
- (420) - Citron [Trim Code P4Y]
- (520) - Red [Trim Code P4R]
- (614) - Gold [Trim Code P4T]

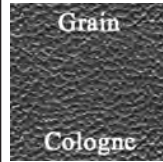

Front Buckets	AA66CF00010(C)
(All colors)	\$744/pr.
Front Bucket Seatback Panels	SK66CF00018(C)
<i>(Heat sealed vinyl seatback panels with new boards)</i>	
(All colors)	\$127/pr.
Power Seat Rail Carpet Kit.....	SK65CFM0020(C)
(All colors)	\$87/ea.
*Please refer to carpet color selection at time of order.	
Center Cushion/Armrest	CR66CFM0013(C)
(All colors)	\$155/ea.
*Please refer to carpet color selection at time of order.	
Hardtop Rear Bench	AA66CF00040(C)
Convertible Rear Bench	AA66CF00050(C)
(All colors)	\$719/ea.
Rear Speaker Cover with Grommet.....	SC65CFMP050(C)
(All colors)	\$93/ea.
Convertible Rear Bench Back Panel	SK64CFMP012
(Board Only)	\$50/ea.
.....	SK64CFMP012
(All colors)	\$77/ea.

1967 SPORT FURY

This Legendary product features as-original Cologne grain inserts with Cologne grain skirts & Bambino grain accent band inlay.

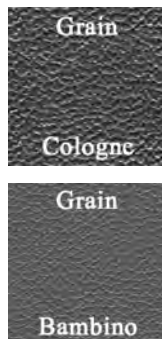

(C) COLOR CODES:

- (100) - Black [Trim Code H6X]
- (202) - Pearl White [Trim Code H6W]
- (321) - Light Blue (318) with Navy (320) Accent [Trim Code H6B]
- (520) - Red [Trim Code H6R]
- (627) - Copper (620) with Dark Copper (626) Accent [Trim Code H6K]

Front Buckets	AA67CF00010(C)
100, 202, 321, 520	\$744/pr.
627	\$998/pr. (L1)
Front Bucket Seatback Panels	SK67CF00018(C)
<i>(Pre-sewn vinyl & carpet seatback panels with new boards)</i>	
100, 202, 318, 520, 620	\$127/pr.
*Please refer to carpet color selection at time of order.	
Center Cushion/Armrest	CR66CFM0013(C)
100, 202, 318, 520, 620	\$155/ea.
*Please refer to carpet color selection at time of order.	
Rear Bench Hardtop (with speaker cutout)	AA67CFS0048(C)
Convertible	AA67CF00056(C)
100, 202, 321, 520	\$719/ea.
627	\$969/ea. (L1)
Convertible Top Motor Cover.....	TP67CFMOTOR
<i>(Cut from black heavy weight panel board)</i>	\$39/ea.

1968 SPORT FURY

This Legendary product features as-original Cologne grain inserts with Cologne grain skirts & Rosette grain accents.

Front BucketsAA68CF00010(C)
 100, 202, 350, 431, 527\$725/pr.
 231.....\$1456/pr. (L1)
 *Metal emblems not included.

Center Cushion/Armrest.....CR68CFMP013(C)
 100, 202, 332, 430, 520.....\$155/ea.
 230.....\$280/ea. (L1)

Hardtop Rear Bench.....AA68CF00040(C)
 Convertible Rear Bench.....AA68CF00050(C)
 100, 202, 350, 431, 527.....\$574/ea.
 231.....\$1287/ea. (L1)
 *Metal emblems not included.
 *231 Parchment/Ember Gold was not available in convertible model.

Convertible Rear Bench Back Panel....SK68CFP0012
 100, 202, 332, 430, 520.....\$77/ea.

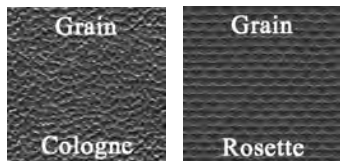

(C) COLOR CODES:

(100) Black [Trim Codes H6X, S6X]
 (202) Pearl White [Trim Codes H6W, S6W]
 (231) Parchment (230) with Ember Gold (636) Accent [Trim Codes H6Y S6Y]
 (350) Light Blue (332) with Dark Blue (330) Accent [Trim Codes H6B, S6B]
 (431) Dark Green (430) with Light Green (432) Accent [Trim Codes H6F, S6F]
 (527) Red (520) with Maroon (526) Accent [Trim Codes H6R, S6R]

***2-Door Hardtop & Convertible Trim Codes - H6X, H6W, H6Y, H6B, H6F, H6R
 ***2-Door Fast-Top Trim Codes - S6X, S6W, S6Y, S6B, S6F, S6R

1964 FURY

This Legendary product features as-original 1/16 Rib grain inserts with heat sealed chrome accent band, silver tinsel accent welt & Bison grain skirts.

(C) COLOR CODES:

(100) Black [Trim Code H4X]
 (312) Dark Blue (333) / Light Blue (314) [Trim Code H6B]
 (422) Dark Turquoise (414) / Light Turquoise (416) [Trim Code H6Q]
 (512) Dark Red (504) / Crimson Red (510) [Trim Code H6R]
 (686) Dark Copper (600) / Copper (606) [Trim Code H6U]

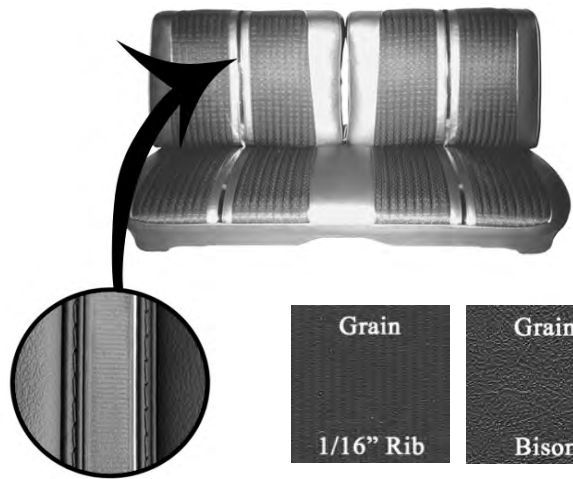

Front Split Bench.....AA64CF00020(C)
 (All colors).....\$755/ea.

Hardtop Rear Bench.....AA64CF00080(C)
 Convertible Rear Bench.....AA64CF00060(C)
 (All colors).....\$567/ea.

1969 SPORT FURY

This Legendary product features as-original Boar grain inserts with Coachman grain skirts.

(C) COLOR CODES:

(100) Black [Trim Code H6X]
 (134) Platinum [Trim Code H6S]
 (200) White [Trim Code H6W]
 (330) Dark Blue [Trim Code H6D]
 (434) Dark Green [Trim Code H6G]
 (528) Red [Trim Code H6R]
 (650) Saddle [Trim Code H6T]

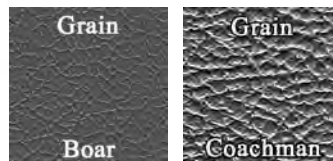

Front BucketsAA69CF00010(C)
 100, 200, 330, 434, 528, 650\$725/pr.
 134.....\$1456/pr. (L1)

Center Cushion/Armrest (with map pocket).....CR69CM00013(C)
 Center Cushion/Armrest (w/o map pocket).....CR69CM0013(C)N
 100, 200, 330, 434, 528, 650\$155/ea.
 134.....\$260/ea. (L1)

Hardtop Rear Bench.....AA69CF00040(C)
 Convertible Rear Bench.....AA69CF00050(C)
 100, 200, 330, 434, 528, 650\$574/ea.
 134.....\$1287/ea. (L1)
 *434 Green & 650 Saddle were not available in convertible model.

1964 FURY "CLOTH STYLE"

This Legendary product features as-original Cloth inserts with heat sealed chrome accent band, silver tinsel accent welt & Bison grain skirts.

(C) COLOR CODES:

(901) Blue Cloth (900) / Light Blue (314) [Trim Code H1B]
 (903) Fawn Tan Cloth (902) / Fawn Tan (610) [Trim Code H1T]
 (905) Turquoise Cloth (904) / Light Turquoise (416) [Trim Code H1Q]
 (907) Red Cloth (906) / Crimson Red (510) [Trim Code H1R]
 (909) Copper Cloth (908) / Copper (606) [Trim Code H1U]

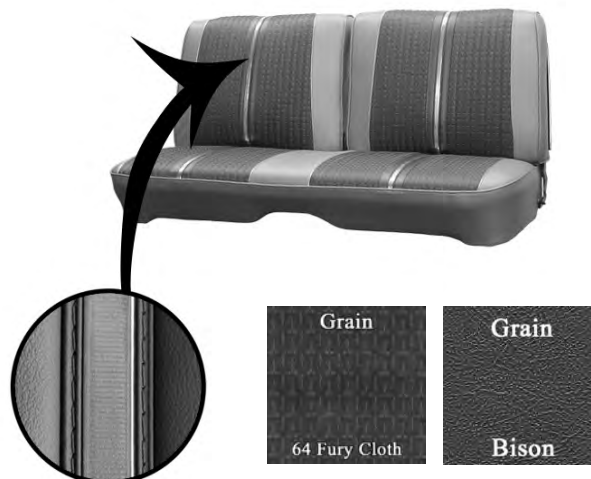

Front Split Bench.....AA64CFC0020(C)
 (All colors).....\$1107/ea. (L1)

Hardtop Rear Bench.....AA64CFC0080(C)
 (All colors).....\$936/ea. (L1)



1964 FURY WAGON & FURY 4-DOOR HARDTOP

This Legendary product features as-original 1/16 Rib grain inserts with heat sealed chrome accent band, silver tinsel accent welt & Bison grain skirts.

(C) COLOR CODES:

- (100) Black [Trim Code H6X]
- (312) Dark Blue (333) / Light Blue (314) [Trim Code H6X]
- (422) Dark Turquoise (414) / Light Turquoise (416) [Trim Code H6X]
- (512) Dark Red (504) / Crimson Red (510) [Trim Code H6X]
- (686) Dark Copper (600) / Copper (606) [Trim Code H6X]
- (697) Dark Fawn Tan (695) / Fawn Tan (610) [Trim Code H6X]



Front Straight Bench.....AA64CF00023(C)
 100, 312, 422, 512, 686.....\$755/ea.
 697.....\$1065/ea. (L1)

Wagon Rear Bench.....AA64CF00044(C)
 312, 422, 512.....\$567/ea.
 697.....\$875/ea. (L1)

*100 Black & 686 Dark Copper/Copper were not available in wagon model.

4-Door Hardtop Rear Bench.....AA64CF00084(C)
 100, 312, 422, 512, 686.....\$567/ea.
 697.....\$875/ea. (L1)

*697 Dark Fawn Tan/Fawn Tan was not available in 4-Door Hardtop model.

1967 FURY III

This Legendary product features as-original Cologne grain inserts & Cologne grain skirts with Bambino grain accent band inlay.

(C) COLOR CODES:

- (100) Black [Trim Code M4X]
- (202) Pearl White [Trim Code M4W]
- (321) Light Blue (318) with Navy (320) Accent [Trim Code M4B]
- (520) Red [Trim Code M4R]
- (627) Copper (620) with Dark Copper (626) Accent [Trim Code M4K]

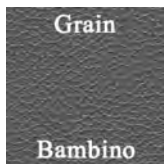

Front Split Bench.....AA67CF30020(C)
 100, 202, 321, 520.....\$759/ea.
 627.....\$995/ea. (L1)

Hardtop Rear Bench.....AA67CF00048(C)
 Convertible Rear Bench.....AA67CF00056(C)
 100, 202, 321, 520.....\$719/ea.
 627.....\$969/ea. (L1)

1967 FURY I "CLOTH STYLE"

This Legendary product features as-original Cloth inserts with Cologne grain skirts.

(C) COLOR CODES:

- (761) Blue Cloth (760) / Light Blue (318) [Trim Code E1B]
- (763) Turquoise Cloth (762) / Light Turquoise (416) [Trim Code E1Q]
- (765) Gold Cloth (764) / Light Gold (618) [Trim Code E1T]

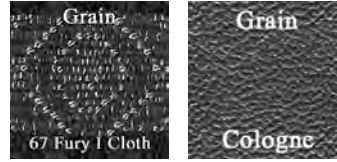

PHOTO N/A
 AT TIME OF
 PRINTING

Front Split Bench.....AA67CF1C020(C)
 761, 763.....\$1164/ea. (L1)
 765.....\$1468/ea. (L1)

2-Door Sedan Rear Bench.....AA67CF1C080(C)
 761, 763.....\$906/ea. (L1)
 765.....\$1174/ea. (L1)

1968 FURY III

This Legendary product features as-original Dorchester grain inserts with Cologne grain skirts.

Front Split Bench with Center Armrest.....AA68CF00030(C)
 100, 202, 350, 527.....\$749/ea.
 441.....\$1114/ea. (L1)
 231.....\$1503/ea. (L1)

*Metal buttons *not* included.

Headrest Covers.....HC68CLMRW14(C)
 100, 202, 332, 430, 520.....\$105/pr.
 230.....\$223/pr. (L1)

Hardtop/Fast Top Rear Bench.....AA68CF00080(C)
 Convertible Rear Bench.....AA68CF00060(C)
 100, 202, 350, 527.....\$574/ea.
 441.....\$947/ea. (L1)
 231.....\$1287/ea. (L1)

*Metal buttons *not* included.

Convertible Rear Seat Back Panel.....SK68CFP0012
 100, 202, 332, 430, 520.....\$77/ea.



(C) COLOR CODES:

- (100) Black [Trim Code M5X]
- (202) Pearl White [Trim Code M5W]
- (231) Parchment (230) with Ember Gold (636) Accent [Trim Code M5Y]
- (350) Light Blue (332) with Dark Blue (330) Accent [Trim Code M5B]
- (441) Antique Green (455) / Dark Green (430) with Light Green (432) Accent [Trim Code M5G]
- (527) Red (520) with Maroon (526) Accent [Trim Code M5R]

1968 FURY III 4-DOOR & SPORT SUBURBAN WAGON

This Legendary product features as-original Dorchester grain inserts with Cologne grain skirts.

Front Split Bench with Center Armrest	AA68CF00030(C)
100, 350, 527	\$749/ea.
621	\$906/ea. (L1)
454	\$1114/ea. (L1)
231	\$1503/ea. (L1)

*Metal buttons not included.

Headrest Covers.....	HC68CLMRW14(C)
100, 332, 432, 520	\$105/pr.
230	\$223/pr. (L1)

Wagon Rear Bench	AA68CF00044(C)
100, 350, 527	\$574/ea.
454	\$947/ea. (L1)

*Metal buttons not included.

*231 Parchment/Ember Gold was not available in wagon model.

*Rear bench not available for 4-door hardtop & sedan models.



(C) COLOR CODES:

- (100) Black [Trim Code M5X]
- (231) Parchment (230) with Ember Gold (636) Accent [Trim Code M5Y]
- (350) Light Blue (332) with Dark Blue (330) Accent [Trim Code M5B]
- (454) Antique Green (455) / Light Green (432) with Dark Green (430) Accent [Trim Code M5G]
- (527) Red (520) with Maroon (526) Accent [Trim Code M5R]
- (621) Light Fawn (634) with Dark Brown (622) Accent [Trim Code M5T]

1969 FURY III 2-DOOR, 4-DOOR & SPORT SUBURBAN WAGON

This Legendary product features as-original Boar grain inserts with Coachman grain skirts.

Front Split Bench with Center Armrest	AA69CF00030(C)
100, 200, 351, 435, 528, 651	\$749/ea.
134	\$1503/ea. (L1)

*Metal buttons not included.

Headrest Covers.....	HC69CRW0014(C)
100, 200, 330, 434, 528, 650	\$105/pr.
134	\$223/pr. (L1)

2-Door Hardtop Rear Bench.....	AA69CF00080(C)
4-Door Hardtop Rear Bench.....	AA69CF00082(C)
Convertible Rear Bench	AA69CF00060(C)
100, 200, 351, 435, 528, 651.....	\$574/ea.
134.....	\$1287/ea. (L1)

*Metal buttons not included.

*134 Platinum, 435 Light Green/Dark Green & 651 Bronze/Saddle were not available in convertible model.

*200 White was not available in 4-Door hardtop & sedan model.

*Rear bench not available for sedan & wagon models.

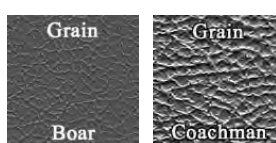

(C) COLOR CODES:

- (100) Black [Trim Code M5X]
- (134) Platinum [Trim Code M5X]
- (200) White [Trim Code M5X]
- (351) Light Blue (332) / Dark Blue (330) [Trim Code M5X]
- (435) Light Green (432) / Dark Green (434) [Trim Code M5X]
- (528) Red [Trim Code M5X]
- (651) Bronze (640) / Saddle (650) [Trim Code M5X]

1957 CHRYSLER 300C "LEATHER STYLE"

This Legendary product features as-original Leather inserts with Leather skirts.

(C) COLOR CODES:

- (649) Tan [Trim Code 60]



Front Split Bench	AA57CML0020(C)
649	\$1749/ea. (L3)

*Due to complicated construction of this upholstery, we highly recommend that this kit be installed by an experienced professional.

Front Bench Seatback Panel.....	SK57CML0018(C)
(Heat sealed vinyl on new boards)	
649	\$226/pr. (L3)

Hardtop Rear Bench.....	AA57CML0080(C)
Convertible Rear Bench	AA57CML0060(C)
649	\$1599/ea.

Convertible Rear Seatback Panel	SK57CML0019(C)
649	\$141/ea. (L3)

1963 CHRYSLER 300

This Legendary product features as-original heat-sealed Basketweave inserts with Bison skirts.

(C) COLOR CODES:

- (204) Dark White [Trim Code 227]
- (206) Taupe [Trim Code 223]
- (339) Blue [Trim Code 221]
- (406) Turquoise [Trim Code 228]
- (530) Claret Red [Trim Code 225]

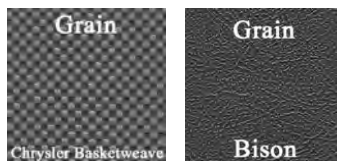

PHOTO N/A AT TIME OF PRINTING

Front Buckets	AA63CM00010(C)
(All colors).....	\$809/pr.

*Molded foam is available for this model. See the "Molded Foam" section in this catalog.

*Specify carpet color of stretch panel at time of order.

Front Bucket Seatback Panels.....	SK63CM00018(C)
(Pre-sewn vinyl and carpet panels with new boards)	
(All colors).....	\$201/ea.

*Specify carpet color at time of order.

Power Seat Rail Carpet Kit.....	SK63CFMP020(C)
.....	\$87/ea.

*Specify carpet color at time of order.

Hardtop Rear Bench.....	AA63CM00040(C)
(All colors).....	\$752/ea.



**1963 CHRYSLER 300J
"LEATHER STYLE"**

*This Legendary product features as-original
Leather inserts with Bison skirts.*

(C) COLOR CODES:

(530) Claret Red [Trim Code 245]

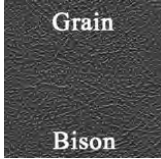

PHOTO N/A
AT TIME OF
PRINTING

Front Buckets	AA63CML0010(C)
530	\$1629/pr. (L3)
<i>*Molded foam is available for this model. See the "Molded Foam" section in this catalog.</i>	
Seatback Panel	SK63CM00018(C)
.....	\$201/ea.
<i>(Pre-sewn vinyl and carpet panels with new boards)</i>	
Power Seat Rail Carpet Kit.....	SK63CFMP02053035
(All colors)	\$87/ea.
Hardtop Rear Bench.....	AA63CML0040(C)
530.....	\$1762/ea. (L3)

1964 CHRYSLER 300 & 300K

*This Legendary product features as-original heat sealed
Basketweave grain inserts with Bison grain skirts.*

(C) COLOR CODES:

- (100) Black [Trim Code M4X]
- (202) Pearl White [Trim Code M4W]
- (314) Blue [Trim Code M4B]
- (520) Red [Trim Code M4R]
- (610) Fawn Tan [Trim Code M4T]

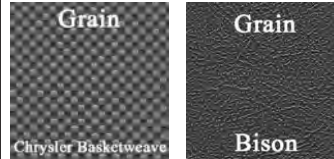

Front Buckets	AA64CM00010(C)
(All colors)	\$809/pr.
<i>*Specify carpet color of stretch panel at time of order.</i>	
<i>*Molded foam is available for this model. See the "Molded Foam" section in this catalog.</i>	
<i>*Bucket seat upholstery is correct for both 2 & 4-Door models.</i>	
Headrest Covers	HC64CM00014(C)
(All colors)	\$110/pr.
Center Cushion/Armrest	CR64CM00013(C)
(All colors)	\$155/ea.
<i>*Specify carpet color of stretch panel at time of order.</i>	
Power Seat Rail Carpet Kit.....	SK64CFMP020(C)
(All colors)	\$87/ea.
<i>*Specify carpet color at time of order.</i>	
Hardtop Rear Bench (2-Door).....	AA64CM00040(C)
Hardtop Rear Bench (4-Door).....	AA64CM00084(C)
Convertible Rear Bench	AA64CM00050(C)
(All colors)	\$752/ea.
Convertible Rear Speaker Cover.....	SC64CFMP050(C)
(All colors)	\$93/ea.
Convertible Rear Bench Back Panel	SK64CFMP012(C)
(Plain board only)	\$50/ea.
(All colors)	\$77/ea.

1964 CHRYSLER 300 & 300K "LEATHER STYLE"

This Legendary product features as-original Tuck and Roll Leather inserts & collars with Bison grain skirts.

(C) COLOR CODES:

- (100) Black [Trim Code M8X]
- (202) Pearl White [Trim Code M8W]

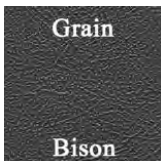

Front Buckets	AA64CML0010(C)
100.....	\$1379/pr. (L3)
202.....	\$1626/pr. (L3)
<i>*Molded foam is available for this model. See the "Molded Foam" section in this catalog.</i>	
<i>*Bucket seat upholstery is correct for both 2 & 4-Door models.</i>	
Center Cushion/Armrest	CR64CML0013(C)
100.....	\$189/ea. (L3)
202.....	\$234/ea. (L3)
<i>*Specify stretch panel carpet color at time of order.</i>	
Power Seat Rail Carpet Kit.....	SK64CFMP020(C)
(All colors)	\$87/ea.
<i>*Specify carpet color at time of order.</i>	
Hardtop Rear Bench (2-Door).....	AA64CML0040(C)
Convertible Rear Bench	AA64CML0050(C)
100.....	\$1529/ea. (L3)
202.....	\$1762/ea. (L3)
Convertible Rear Bench Back Panel	SK64CFMP012(C)
(Plain board only)	\$50/ea.
(All colors)	\$77/ea.

1965 CHRYSLER 300 & 300L

This Legendary product features as-original Basketweave grain inserts with heat sealed upper panels & Cologne grain skirts.

(C) COLOR CODES:

- (100) Black [Trim Codes M4X, P4X]
- (202) Pearl White [Trim Codes M4W, P4W]
- (316) Blue-Black Filled (313) / Blue (322) [Trim Codes M4B, P4B]
- (517) Red-Black Filled (516) / Red (520) [Trim Codes M4R, P4R]
- (605) Dark Brown-Black Filled (607) / Fawn Tan (610) [Trim Codes M4T, P4T]
- (643) Gold-Black Filled (628) / Gold (614) (Requires Sample Approval) [Trim Codes M4L, P4L]

***Chrysler 300 Trim Codes - M4X, M4W, M4B, M4R, M4T, M4L

***Chrysler 300L Trim Codes - P4X, P4W, P4B, P4R, P4T, P4L

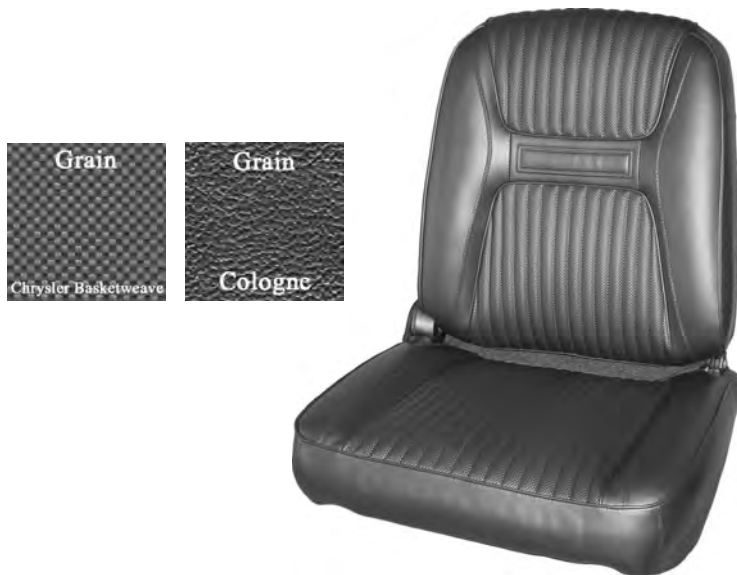

Front Buckets	AA65CM00010(C)
100, 202.....	\$809/pr.
316, 517, 643.....	\$1257/pr. (L1)
605	\$1701/pr. (L1)

*All NOS inserts are 2-tone.

*Reproduction inserts also available in single color.

*Specify carpet color of stretch panel at time of order.

*Molded foam is available for this model. See the "Molded Foam" section in this catalog.

*Bucket seat upholstery is correct for both 2 & 4-Door models.

Headrest Covers.....	HC65CM00014(C)
100, 202, 322, 520, 610, 614.....	\$110/pr.

Center Cushion/Armrest.....	CR65CMN0013(C)
100, 202, 322, 520, 610, 614.....	\$155/ea.

Power Seat Rail Carpet Kit.....	SK65CFMP020(C)
(All colors).....	\$87/ea.

*Specify carpet color at time of order.

Hardtop Rear Bench (2-Door).....	AA65CM00040(C)
Convertible Rear Bench	AA65CM00050(C)
100, 202.....	\$752/ea.
316, 517, 643.....	\$1033/ea. (L1)
605.....	\$1358/ea. (L1)

Convertible Rear Speaker Cover.....	SC65CFMP050(C)
100, 202, 322, 520, 610, 614.....	\$93/ea.

Convertible Rear Bench Back Panel	SK64CFMP012(C) 
(Plain board only).....	\$50/ea.
(All colors).....	\$77/ea.

1965 CHRYSLER 300 & 300L "LEATHER STYLE"

This Legendary product features as-original Tuck & Roll Leather inserts & face with Cologne grain skirts.

(C) COLOR CODES:

- (100) Black [Trim Codes M3X, P3X]
- (520) Red [Trim Codes M3R, P3R]

***Chrysler 300 Trim Codes - M3X, M3R

***Chrysler 300L Trim Codes - P3X, P3R



Front Buckets	AA65CML0010(C)
100.....	\$1379/pr. (L3)
520.....	\$1626/pr. (L3)

*Specify carpet color of stretch panel at time of order.

*Molded foam is available for this model. See the "Molded Foam" section in this catalog.

*Due to complicated construction of this upholstery, we highly recommend that this kit be installed by an experienced professional.

Headrest Covers.....	HC65CM00014(C)
(All colors).....	\$110/pr.

Center Cushion/Armrest.....	CR65CMLN013(C)
100.....	\$189/ea. (L3)
520.....	\$234/ea. (L3)

*Specify carpet color at time of order.

Power Seat Rail Carpet Kit.....	SK65CFMP020(C)
(All colors).....	\$87/ea.

*Specify carpet color at time of order.

Hardtop Rear Bench (2-Door).....	AA65CML0040(C)
Convertible Rear Bench	AA65CML0050(C)
100.....	\$1529/ea. (L3)
520.....	\$1762/ea. (L3)

Convertible Rear Speaker Cover.....	SC65CFMP050(C)
(All colors).....	\$93/ea.

Convertible Rear Bench Back Panel	SK64CFMP012(C) 
(Plain board only).....	\$50/ea.
(All colors).....	\$77/ea.



1966 CHRYSLER 300

This Legendary product features as-original Cologne grain inserts & upper insert with Cologne grain skirts.

(C) COLOR CODES:

- (100) Black [Trim Code M4X]
- (102) Silver [Trim Code M4A]
- (202) Pearl White [Trim Code M4W]
- (320) Navy [Trim Code M4D]
- (520) Red [Trim Code M4R]
- (616) Ginger Tan [Trim Code M4T]

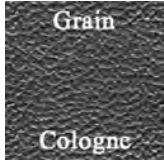

Front Buckets **AA66CM00010(C)**
(All colors)..... \$754/pr.

**Bucket seat upholstery is correct for both 2 & 4-Door models.*

Front Bucket Seatback Panels **SK66CM00018(C)**
(Pre-sewn vinyl & carpet back panels with new boards)
(All colors)..... \$127/pr.

**Specify carpet color at time of order.*

Center Cushion/Armrest **CR66CFM0013(C)**
(All colors)..... \$155/ea.

**Specify carpet color at time of order.*

Hardtop Rear Bench (2-Door)..... **AA66CM00040(C)**
 Convertible Rear Bench **AA66CM00050(C)**
(All colors)..... \$649/ea.

Convertible Rear Bench Back Panel **SK64CFMP012(C)**
(Plain board only)..... \$50/ea.
(All colors)..... \$77/ea.

**1966 CHRYSLER 300
 "LEATHER STYLE"**

This Legendary product features as-original Leather collars & upper insert with Cologne grain skirts.

(C) COLOR CODES:

- (100) Black [Trim Code M3X]
- (520) Red [Trim Code M3R]

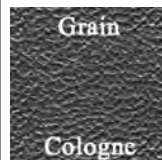

Front Buckets (Reclining passenger)..... **AA66CMLR010(C)**
100..... \$1232/pr. (L3)
520..... \$1562/pr. (L3)

Front Bucket Seatback Panels **SK66CM00018(C)**
(Pre-sewn vinyl & carpet back panels with new boards)
(All colors)..... \$127/pr.

**Specify carpet color at time of order.*

Center Cushion/Armrest **CR66CML0013(C)**
100..... \$189/ea. (L3)
520..... \$234/ea. (L3)

**Specify carpet color at time of order.*

Hardtop Rear Bench (2-Door)..... **AA66CML0040(C)**
 Convertible Rear Bench **AA66CML0050(C)**
100..... \$1074/ea. (L3)
520..... \$1350/ea. (L3)

Convertible Rear Bench Back Panel **SK64CFMP012(C)**
(Plain board only)..... \$50/ea.
(All colors)..... \$77/ea.

1966 CHRYSLER 300 "CLOTH STYLE"

This Legendary product features as-original Cologne grain collars & upper insert with Cloth lower insert & Cologne grain skirts

(C) COLOR CODES:

- (936) Black Cloth (938) / Pearl White (202) [Trim Code M1N]
- (937) Blue Cloth (939) / Navy (320) [Trim Code M1D]

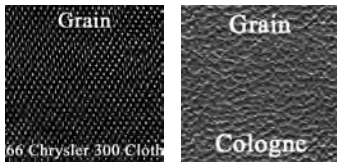

Front Buckets (Reclining passenger)..... **AA66CMCR010(C)**
(All colors)..... \$1070/pr. (L1)

**Bucket seat upholstery is correct for both 2 & 4-Door models.*

Front Bucket Seatback Panels **SK66CM00018(C)**
(Pre-sewn vinyl & carpet back panels with new boards)
202, 320..... \$148/pr.

**Specify carpet color at time of order.*

Center Cushion/Armrest **CR66CFM0013(C)**
202, 320..... \$155/ea.

**Specify carpet color at time of order.*

Hardtop Rear Bench (2-Door)..... **AA66CMC0040(C)**
(All colors)..... \$902/ea. (L1)

1968 CHRYSLER 300, NEWPORT & NEWPORT CUSTOM

This Legendary product features as-original Oxford grain inserts with Cologne grain skirts.

(C) COLOR CODES:

- (150) Antique Dark Gray (112) / Black (100) [Trim Codes E6X, M6X, L6X]
- (202) Pearl White [Trim Codes E6W, M6W]
- (329) Antique Blue (307) / Dark Blue (330) [Trim Codes E6B, M6B, L6B]
- (436) Antique Green (425) / Dark Green (430) [Trim Codes E6F, M6F, L6F]
- (539) Antique Red (536) / (520) Red [Trim Code E6R, M6R, L6R]

***Newport Trim Codes - E6X, E6W, E6B, E6F, E6R
 ***Newport Custom Trim Codes - L6X, L6B, L6F, L6R
 ***Chrysler 300 Trim Codes - M6X, M6W, M6B, M6F, M6R

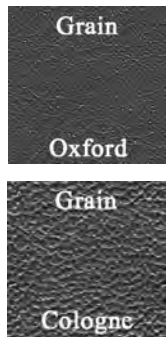

- Front Buckets (Non-Reclining passenger) AA68CM00010(C)
- Front Buckets (Reclining passenger)..... AA68CMR0010(C)
- 202..... \$740/pr.
- 150, 329, 436, 539..... \$989/pr. (L1)

*Metal emblems not included.
 *202 Pearl White made in all Cologne Grain as original.
 *202 Pearl White was not available in Newport Custom model.
 *Bucket seats were available in both Chrysler 300 & Newport Custom 2 & 4-Door models only.

- Headrest Covers..... HC68CLMRW14(C)
- 100, 202, 330, 430, 520..... \$105/pr.

- Center Cushion/Armrest (with map pocket)..... CR68CFMP013(C)
- Center Cushion/Armrest (without map pocket)..... CR68CM00013(C)
- 100, 202, 330, 430, 520..... \$155/ea.

- Hardtop Rear Bench (2-Door)..... AA68CM00040(C)
- Convertible Rear Bench AA68CM00050(C)
- 202..... \$630/ea.
- 150, 329, 436, 539..... \$780/ea. (L1)

*Metal emblems not included.
 *202 Pearl White made in all Cologne Grain as original.
 *202 Pearl White was not available in Newport Custom model.
 *436 Antique Green / Dark Green was not available in convertible models.
 *539 Antique Red / Red was not available in Newport 2-Door hardtop model.

1968 CHRYSLER 300 "CLOTH STYLE"

This Legendary product features as-original Cologne grain inserts with Cologne grain skirts.

(C) COLOR CODES:

- (891) Black Cloth (892) / Black (100) [Trim Code M7X]

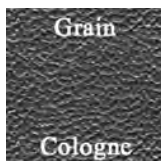

- Front Buckets (Reclining passenger)..... AA68CMCR010(C)
- 891..... \$1153/pr. (L1)

*Metal emblems not included.
 *Bucket seat upholstery is correct for both 2 & 4-Door models.

- Headrest Covers..... HC68CLMRW14(C)
- 100..... \$105/pr.

- Center Cushion/Armrest (with map pocket)..... CR68CFMP013(C)
- Center Cushion/Armrest (without map pocket)..... CR68CM00013(C)
- 100..... \$155/ea.

- Hardtop Rear Bench (2-Door)..... AA68CMC0040(C)
- 891..... \$920/ea. (L1)

*Metal emblems not included.

1969 CHRYSLER 300 & NEWPORT

This Legendary product features as-original Star grain inserts with Coachman grain skirts.

(C) COLOR CODES:

- (100) Black [Trim Codes E6X, M6X]
- (200) White [Trim Codes E6W, M6W]
- (336) Navy [Trim Code M6D]
- (434) Green [Trim Code M6G]
- (650) Saddle [Trim Codes E6T, M6T]

***Newport Trim Codes - E6X, E6W, E6T
 ***Chrysler 300 Trim Codes - M6X, M6W, M6D, M6G, M6T

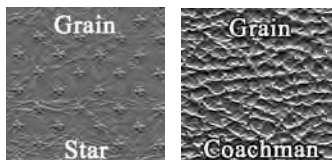

- Front Buckets (Non-reclining)..... AA69CM00010(C)
- Front Buckets (Reclining passenger)..... AA69CMR0010(C)
- (All colors)..... \$740/pr.

*Metal emblems not included.
 *Bucket seat upholstery is correct for both 2 & 4-Door Chrysler 300 models.
 *Reclining passenger seat was only offered in Black for 1969 models.

- Center Cushion/Armrest (with map pocket)..... CR69CM00013(C)
- Center Cushion/Armrest (without map pocket)..... CR69CM0013(C)
- (All colors)..... \$155/ea.

- Hardtop Rear Bench (2-Door)..... AA69CM00040(C)
- Convertible Rear Bench AA69CM00050(C)
- (All colors)..... \$630/ea.

*Metal emblems not included.



1969 CHRYSLER 300 "CLOTH STYLE"

This Legendary product features as-original Cloth inserts with Coachman grain skirts.

(C) COLOR CODES:

(689) Tan Cloth (688) / Beige (687) [Trim Code M7X]

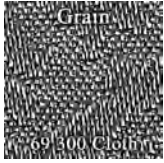

Front Buckets (Reclining passenger)..... **AA69CMCR010(C)**
689.....\$1178/pr. (L1)
 *Metal emblems not included.
 *Bucket seat upholstery is correct for both 2 & 4-Door Chrysler 300 models.

Center Cushion/Armrest (with map pocket)..... **CR69CM00013(C)**
 Center Cushion/Armrest (without map pocket)..... **CR69CM0013(C)N**
687.....\$155/ea.

Hardtop Rear Bench (2-Door)..... **AA69CMC0040(C)**
689.....\$906/ea. (L1)
 *Metal emblems not included.

1970 CHRYSLER 300 "CLOTH STYLE"

This Legendary product features as-original Cloth inserts with Coachman grain skirts.

(C) COLOR CODES:

(890) Tan Cloth (889) / Parchment (699) [Trim Code M5L2]



Front Buckets **AA70CMC0010(C)**
890.....\$1178/pr. (L1)
 *Metal emblems not included.
 *Bucket seat upholstery is correct for both 2 & 4-Door Chrysler 300 models.

Center Cushion/Armrest (with map pocket)..... **CR69CM00013(C)**
 Center Cushion/Armrest (without map pocket)..... **CR69CM0013(C)N**
699.....\$155/ea.

Hardtop Rear Bench (2-Door)..... **AA70CMC0040(C)**
890.....\$906/ea. (L1)
 *Metal emblems not included.

1970 CHRYSLER 300 & NEWPORT

This Legendary product features as-original El Paso grain inserts with Coachman grain skirts.

(C) COLOR CODES:

(100) Black [Trim Codes E6X9, M6X9]
 (200) White [Trim Codes E6XW, M6XW]
 (332) Light Blue [Trim Code M6B3]
 (434) Green [Trim Code M6F3]
 (656) Brown [Trim Codes E6T5, M6T5]

***Newport Trim Codes - E6X9, E6XW, E6T5
 ***Chrysler 300 Trim Codes - M6X9, M6XW, M6B3, M6F3, M6T5

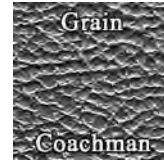
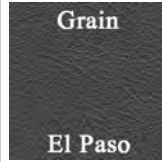

Front Buckets **AA70CM00010(C)**
(All colors).....\$740/pr.
 *Metal emblems not included.
 *Bucket seat upholstery is correct for both 2 & 4-Door Chrysler 300 models.

Center Cushion/Armrest (with map pocket)..... **CR69CM00013(C)**
(All colors).....\$155/ea.

Convertible Rear Bench **AA70CM00050(C)**
(All colors).....\$630/ea.
 *Metal emblems not included.

1970 CHRYSLER 300 HURST EDITION "LEATHER STYLE"

This Legendary product features as-original Tuck & Roll pleated Leather inserts w/ buttons & leather collars - Leather top skirts w/ Coachman grain bottom skirts.

(C) COLOR CODES:

(656) Brown [Trim Code M6T5]

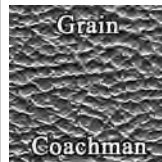

Front Buckets **AA70CMLH010(C)**
656.....\$1699/pr. (L3)

Front Bucket Seatback Panels **SK70CM00018(C)**
 (Vinyl bound carpet back panels)
656.....\$127/pr.
 *Specify carpet color at time of order.

Center Cushion/Armrest **CR70CMLH013(C)**
656.....\$234/ea.

Hardtop Rear Bench **AA70CMLH040(C)**
656.....\$1649/ea. (L3)
 *Specify carpet color at time of order.

1971 CHRYSLER 300 & NEWPORT

This Legendary product features as-original Ascot grain inserts & skirts with Coachman grain collars.

(C) COLOR CODES:

- (100) Black [Trim Codes E6X9, S6X9]
- (200) White [Trim Codes E6XW, S6XW]
- (452) Green [Trim Code S6F7]
- (664) Brown [Trim Codes E6T7, S6T7]
- (699) Beige [Trim Code S6L2]

***Newport Trim Codes - E6X9, E6XW, E6T7
 ***Chrysler 300 Trim Codes - S6X9, S6XW, S6F7, S6T7, S6L2

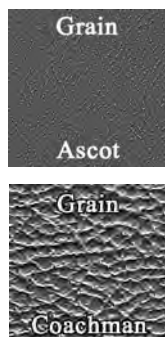

Front Buckets AA71CM00010(C)
 (All colors).....\$803/pr.
 *Bucket seat upholstery is correct for both 2 & 4-Door models.

Center Cushion/Armrest (with map pocket)..... CR69CM00013(C)
 Center Cushion/Armrest (w/o map pocket)..... CR69CM0013(C)N
 (All colors).....\$155/ea.

Hardtop Rear Bench (2-Door)..... AA71CM00040(C)
 (All colors).....\$695/ea.

1968 CHRYSLER 300, NEWPORT, TOWN & COUNTRY WAGON

This Legendary product features as-original Oxford grain inserts with Cologne grain skirts with center armrest.

(C) COLOR CODES:

- (150) Antique Dark Gray (112) / Black (100) [Trim Codes E5X, M5X]
- (329) Antique Blue (307) / Dark Blue (330) [Trim Codes E5B, M5B]
- (539) Antique Red (536) / (520) Red [Trim Code E5R]

***Town & Country Wagon & Newport Trim Codes - E5X, E5B, E5R
 ***Chrysler 300 Trim Codes - M5X, M5B



Front Split Bench..... AA68CM00030(C)
 150, 329, 436, 539.....\$1040/ea. (L1)

1976 ASPEN CUSTOM, ASPEN R/T, VOLARE CUSTOM & ROADRUNNER

This Legendary product features as-original Richmond grain inserts with Oxford grain skirts.

(C) COLOR CODES:

- (108) Silver (118) / Black (100) [Trim Code D6X9]
- (215) Pearl White (215) / White (200) [Trim Codes D6XW, D6BW, D6EW, D6FW]
- *D6XW - White w/ Black Carpet
- *D6BW - White w/ Blue Carpet
- *D6EW - White w/ Dark Red Carpet
- *D6FW - White w/ Green Carpet
- (552) Dark Red (554) / Dark Red (553) [Trim Code D6E7]



Front Buckets (1976)..... AA76CR00010(C)
 108, 215, 552.....\$1285/ea. (L1)
 *Customer must reuse decorative buttons.

Rear Bench (1976)..... AA76CR00048(C)
 108, 215, 552.....\$1007/ea. (L1)
 *Customer must reuse decorative buttons.

1977 ASPEN CUSTOM, ASPEN R/T, VOLARE CUSTOM & ROADRUNNER

This Legendary product features as-original Shallow Elk grain inserts with Oxford grain skirts.

(C) COLOR CODES:

- (100) Black [Trim Code D6X9]
- (200) White [Trim Codes D6XW, D6BW, D6EW, D6FW]
- *D6XW - White w/ Black Carpet
- *D6BW - White w/ Blue Carpet
- *D6EW - White w/ Dark Red Carpet
- *D6FW - White w/ Green Carpet
- (553) Dark Red [Trim Code D6E7]



Front Buckets..... AA77CR00010(C)
 100, 200.....\$547/ea. (L1)
 553.....\$1281/ea. (L1)
 *Customer must reuse decorative buttons.

Rear Bench..... AA77CR00048(C)
 100, 200.....\$340/ea. (L1)
 553.....\$1007/ea. (L1)
 *Customer must reuse decorative buttons.



1964-68 DODGE/FARGO A-100 VAN & A-100 PICKUP

This Legendary product features as-original heat sealed Bison grain inserts with Bison grain skirts for 1964-1967 models and Coachman grain inserts with Coachman grain skirts for 1968 models.

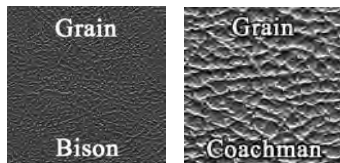

(C) COLOR CODES:

(100) Black

Front Buckets (2" pleat) (1964-67) **AA64CA20010(C)**
100 \$519/pr.

Front Buckets (2" pleat) (1968 only) **AA68CA20010(C)**
100 \$519/pr.

Please call for additional color availability

1964-65 DODGE TRUCK CSS "CUSTOM SPORTS SPECIAL"

This Legendary product features as-original heat sealed Bison grain inserts with heat sealed chrome emblem and Bison grain skirts.

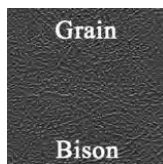

(C) COLOR CODES:

(101) Black with Silver Tinsel welt

(C) SEATBACK PANEL COLOR CODES:

(100) Black

Front Buckets **AA64CL00010(C)**
100 \$690/pr.

Molded foam is available for this model. See the "Molded Foam" section in this catalog.

Front Bucket Seatback Panels **SK64CL00018(C)**
(Pre-sewn vinyl panels with new boards)
100 \$175/pr.

Console Carpet Kit **CC62CFPR(C)**
(80/20 Loop) \$71/kit

1966 DODGE TRUCK CSS "CUSTOM SPORTS SPECIAL"

This Legendary product features as-original Cologne grain inserts and Cologne grain skirts.

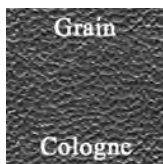

(C) COLOR CODES:

(100) Black

Front Buckets **AA66CL00010(C)**
100 \$542/pr.

Molded foam is available for this model. See the "Molded Foam" section in this catalog.

Console Carpet Kit **CC62CFPR(C)**
(80/20 Loop) \$71/kit

1967 DODGE TRUCK CSS "CUSTOM SPORTS SPECIAL"

This Legendary product features as-original heat sealed Cologne grain inserts with Cologne grain skirts.

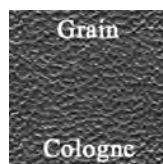

(C) COLOR CODES:

(100) Black

Front Buckets **AA67CL00010(C)**
100 \$542/pr.

Metal emblems not included.

Molded foam is available for this model. See the "Molded Foam" section in this catalog.

Console Carpet Kit **CC62CFPR(C)**
(80/20 Loop) \$71/kit



**1972-73 DODGE TRUCK
D/W SERIES**

This Legendary product features as-original heat sealed El Paso grain inserts with Coachman grain skirts for conventional cab models only.

(C) COLOR CODES:

- (100) - Black [Trim Code KT1]
- (250) - Parchment [Trim Code KT4]

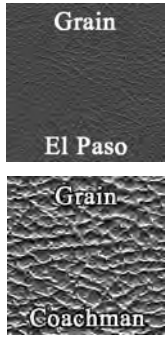

Front Buckets	AA73CDT0010(C)
(All colors).....	\$519/pr.
<i>*Metal emblems not included.</i>	
Center Cushion/Armrest	CR73CDT0013(C)
(All colors).....	\$135/ea.

**1974 DODGE TRUCK
D/W SERIES**

This Legendary product features as-original heat sealed Oxen grain inserts with Oxford grain skirts for conventional cab models only.

(C) COLOR CODES:

- (100) - Black [Trim Code KT1]
- (264) - Parchment [Trim Code KT4]

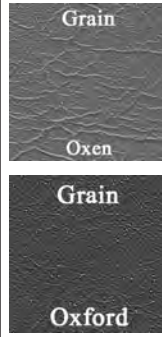

Front Buckets	AA74CDT0010(C)
100.....	\$519/pr.
264.....	\$504/pr. (L4)
<i>*Metal emblems not included.</i>	
Center Cushion/Armrest	CR74CDT0013(C)
100.....	\$135/ea.
264.....	\$163/ea. (L1)

**1975 DODGE TRUCK
D/W SERIES**

This Legendary product features as-original heat sealed Shallow Elk grain inserts with Oxford grain skirts for conventional cab models only.

(C) COLOR CODES:

- (100) - Black [Trim Code KT1]
- (267) - Metallic Parchment (266) / Parchment (264) [Trim Code KT4]



Front Buckets	AA75CDT0010(C)
100.....	\$519/pr.
267.....	\$750/pr. (L1)
<i>*Metal emblems not included.</i>	
Center Cushion/Armrest	CR74CDT0013(C)
100.....	\$135/ea.
264.....	\$163/ea. (L4)

**1976-79 DODGE TRUCK
D/W SERIES**

Models include: 1976-79 POWER WAGON - 1976-79 WARLOCK - 1976-79 MACHO - 1978 MIDNITE EXPRESS & 1978-79 LI'L RED EXPRESS

This Legendary product features as-original heat sealed Shallow Elk grain inserts with Oxford grain skirts for conventional cab models only.

(C) COLOR CODES:

- (100) - Black [Trim Code KT1] - 1976-1979
- (267) - Metallic Parchment / Parchment [Trim Code KT4] - 1976-1977

****Trucks originally equipped with bucket seats would have a KB5 code on the Equipment Identification tag located on the hood.*



Front Buckets	AA76CDT0010(C)
100.....	\$519/pr.
267.....	\$750/pr. (L1)
<i>*Metal emblems not included.</i>	
Center Cushion/Armrest	CR76CDT0013(C)
100.....	\$135/ea.
264.....	\$163/ea. (L4)
Back Wall Carpet Kit (Cut-pile) 	SK78CDT00210(C)
(All colors).....	\$194/ea.
<i>*Please refer to carpet color selection at time of order.</i>	

1978 DODGE TRUCK D/W SERIES

Models include: POWER WAGON & LI'L RED EXPRESS

This Legendary product features as-original Diamond Waffle grain inserts with Oxford grain skirts for conventional cab models only.

(C) COLOR CODES:

(100) - Black [Trim Code KT1]

(548) - Red [Trim Code KT6]



Front Bench..... **AA78CDT0020(C)**
(All colors)..... \$547/ea.

Back Wall Carpet Kit (Cut-pile) ..... **SK78CDT00210(C)**
(All colors)..... \$194/ea.

**Please refer to carpet color selection at time of order.*

1979 DODGE TRUCK D/W SERIES

Models include: POWER WAGON & LI'L RED EXPRESS

This Legendary product features as-original El Paso grain inserts with El Paso grain skirts for conventional cab models only.

(C) COLOR CODES:

(100) - Black [Trim Code KT1]

(548) - Red [Trim Code KT6]

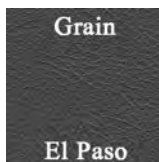

Front Bench..... **AA79CDT0020(C)**
(All colors)..... \$547/ea.

Back Wall Carpet Kit (Cut-pile) ..... **SK78CDT00210(C)**
(All colors)..... \$194/ea.

**Please refer to carpet color selection at time of order.*

PLASTIC SEATBACK COVERS



Reproduction plastic seat back covers for 1970-74 B-Body models.

1970 B-Body (OEM - Injection Molded)

SK70ABE0M18100 (Black)..... \$299.00/pr.

SK70ABE0M18200 (White)..... \$299.00/pr.

1971-74 B-Body (OEM - Injection Molded)

SK71ABE0M18100 (OEM) (Black)..... \$299.00/pr.

SK71ABE0M18200 (OEM) (White)..... \$299.00/pr.

HINGE COVERS



1964-67 B-Body reproduction hinge covers for bench seat models. Screws included.

HG64CRW01 (Black)..... \$59.00/pr.

HG64CRW02 (White)..... \$59.00/pr.



1968-70 B-Body reproduction hinge covers for bench seat models. Screws included.

HG68CRW01 (Black)..... \$59.00/pr.

HG68CRW02 (White)..... \$59.00/pr.



1968-69 B-Body reproduction hinge covers for bucket seat models. Screws included.

HG68CBLRVWX01 (Black)..... \$59.00/pr.

HG68CBLRVWX02 (White)..... \$59.00/pr.

HINGE COVERS CONT.



NEW!!!

NEW!!!

1971-74 B-Body reproduction hinge covers for bucket seat models. Screws included.

HG71CRX01 (Black)..... \$69.00/pr.

HG71CRX02 (White)..... \$69.00/pr.

CENTER ARMREST HINGE WASHER

Side hinge washers made of die-cut polypropylene for bucket seat models with optional center armrest. These washers protect the vinyl from wear when the armrest is folded in the up or down position.

HG66WASHER..... \$ 4.00/pr.

BUCKET SEAT HINGE WASHER



Black panel board washers help protect the skirts on your upholstery from wear. These washers come in a set of (4) and work for all 1966-74 B-Body bucket seats.

TAHINGEWASHER (Set/4)..... \$ 3.00/set



SEAT SPRING KITS

1962-65 A, B & C-BODY

Bucket Seat Top & Bottom Spring Kit

Each kit consists of (4) individual seat top springs and (1) seat bottom spring assembly.

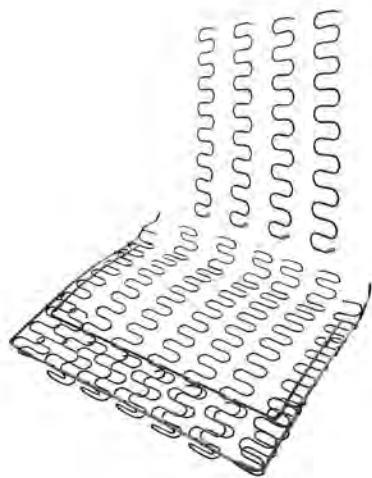

SA62CABC \$159.00/kit

- ☞ (1) Kit does (1) complete bucket seat
- ☞ (2) Kits must be ordered to do a pair of bucket seats
- ☞ Sold as a top and bottom kit only

1968-69 A & B-BODY

Bucket Seat Top & Bottom Spring Kit

Each kit consists of (4) individual seat top springs and (1) seat bottom spring assembly.

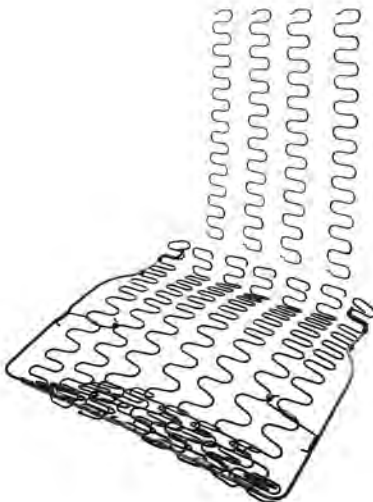

SA68CAB \$159.00/kit

- ☞ (1) Kit does (1) complete bucket seat
- ☞ (2) Kits must be ordered to do a pair of bucket seats
- ☞ Sold as a top and bottom kit only

1966-67 A & B-BODY

Bucket Seat Top & Bottom Spring Kit

Each kit consists of (4) individual seat top springs and (1) seat bottom spring assembly.

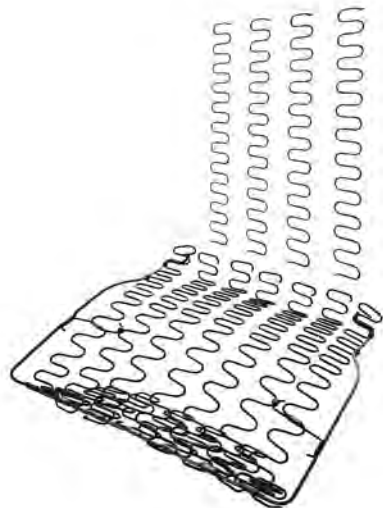

SA66CAB \$159.00/kit

- ☞ (1) Kit does (1) complete bucket seat
- ☞ (2) Kits must be ordered to do a pair of bucket seats
- ☞ Sold as a top and bottom kit only

1970-71 A, B & E-BODY

Bucket Seat Top & Bottom Spring Kit

Each kit consists of (1) seat top spring assembly and (1) seat bottom spring assembly.

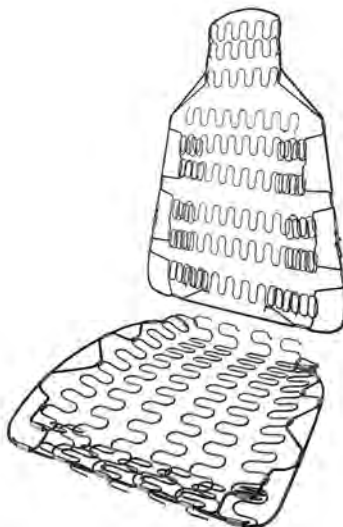

SA70CABE \$259.00/kit

- ☞ (1) Kit does (1) complete bucket seat
- ☞ (2) Kits must be ordered to do a pair of bucket seats
- ☞ Sold as a top and bottom kit only

UNIVERSAL COIL SPRINGS

Bench Seat & Rear Seat

Universal coil seat springs used in automotive interiors to absorb shock and give added resilience to the seat. Used in all makes and models dating back to the 1930's.

NOTE: When choosing an upholstery coil seat spring, measure the overall height when not under pressure.



SACOIL4 (4" Tall - 13 Gauge)..... \$7.00/ea.

SACOIL4.5 (4.5" Tall - 13 Gauge).... \$7.00/ea.

SACOIL5 (5" Tall - 12 Gauge)..... \$7.00/ea.

SACOIL5.5 (5.5" Tall - 12 Gauge).... \$7.00/ea.

☞ Applications Include: Front Split Bench Seats, Front Straight Bench Seats, Hardtop Rear Seats, Sedan/Coupe Rear Seats & Convertible Rear Seats

3 3/8" INTERLOCKING SPRING

Long Bench Seat & Rear Seat

3 3/8" long spring used in automotive interiors to tie together the coil seat springs which absorb shock and give added resilience to the seat. Used in all makes and models dating back to the 1930's



SASPRING \$2.00/ea.

☞ Applications Include: Front Split Bench Seats, Front Straight Bench Seats, Hardtop Rear Seats, Sedan/Coupe Rear Seats & Convertible Rear Seats

Chrysler, Dodge, Plymouth

BUCKET SEAT CATCH



Bucket seat catch for 1970-74 B-Body models locks the front seat top in place and keeps it from falling forward.

TA70ABE-SEATCTCH \$39.00/pr.

SEAT SPACER



Reproduction plastic seat spacers for 1966-70 B-Body bucket and bench seat models mount on the seat track studs. Use (4) per seat.

TA66AB-SPACER \$15.00/pk.

SEAT STOPS



Nylon bumpers for B-Body models keep the front seat top in its correct upright position. These mount on the backside of the front seat bottoms.

1962-65 B-Body (Bench)
TA63ABSEATSTOP (shown) \$19.00/pr.

1970-72 B-Body (Bucket)
TA70ABE-SEATSTOP \$29.00/pr.
**STUDS INCLUDED*

SEAT BELTS



Universal aftermarket non-retractable replacement seat belts for all models. These belts feature a "flip" release and are available in 60" & 74" lengths. Mounting hardware included. Sold individually, one belt per passenger.

TNSEATBELT60(C) (60") \$39.00/ea.
TNSEATBELT74(C) (74") \$39.00/ea.
☞ Please specify color at time of order.

(01) Black	(13) Dark Green	(25) Dark Brown
(03) Red	(18) Light Blue	(26) Saddle
(07) Dark Blue	(21) Medium Red	(31) Maroon

FRONT SHOULDER HARNESS MOUNTING COVER



Reproduction front shoulder harness mounting covers for 1967-70 B-Body models.

TN67ABESHOULDER \$49.00/pr.

HEADREST CHROME BANDS



Replacement chrome bands for molded headrests on 1968-70 B-Body bucket and bench seat models.

TACHROME BAND \$39.00/pr.

SEAT BELT MOUNTING COVERS

Reproduction seat belt mounting covers for 1967-70 B-Body models. Made of rubber, these covers install over the driver and passenger belt that mount to the drive shaft tunnel.

TN67ABSBMOUNTCOV \$49.00/pr.

SEAT LATCH RETURN SPRINGS



Seat latch return springs made from 302 stainless, stress relieved steel available for 1968 B-Body w/ bucket style interiors, 1969 B-Body w/ bucket style interiors, & 1970 B-Body w/ bench style interiors. ****LIMITED QUANTITIES AVAILABLE****

TN68C-SLRS \$15.00/ea.

SEATBACK TOP BOARDS



Die-cut seatback top panel boards for 1968-69 B-Body bucket seat models.

SK68ABSEATTOP \$35.00/pr.

SEATBACK BOARDS

Die-cut seatback panel boards for 1968-69 B-Body bucket seats and 1966-72 B-Body bench seats. Customer must reuse original clips and bottom edge rails.



SK68AB00018 ('68-'69 B-Body Buckets) \$41.00/pr.

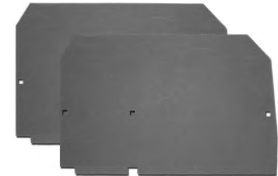

SK66B00018 ('66-'67 B-Body Bench) \$41.00/pr.

SK68B00018 ('68-'70 B-Body Bench) \$41.00/pr.

SEATBACK BOARDS

Seatback boards for 1963 300/300J. These boards are placed on the front of the rear seat bottom frame before installing upholstery. Serves as a kick panel board to protect upholstery from tearing if kicked by rear seat passengers.

SK63CM00012 ('63 300/300J Bench) \$24.00/pr.

SEATBACK KITS



These new 1968-69 seatback kits come pre-assembled with vinyl wrapped new boards and all mounting hardware attached. The mounting hardware consists of 4 metal clips per seatback and one lower curved metal bracket that are stapled onto the boards are original.

1968 Dodge/Plymouth B-Body
SK68AB00018 (All Colors) \$167.00/pr.
**NOT for Barracuda models with Deluxe style bucket seats*



1968 Charger
SK68CX00018 (All Colors) \$167.00/pr.



1969 Dodge/Plymouth B-Body
SK69AB00018 (All Colors) \$167.00/pr.





MOLDED FOAM AND FOAM ACCESORIES

 facebook.com/legendaryautointeriors
 twitter.com/legendaryautoin

 www.legendaryautointeriors.com
 instagram.com/legendaryautointeriorsltd
 youtube.com/user/legendaryauto

INSTALLATION KITS

FRONT BUCKET SEATS All 1960-79 Dodge/Chrysler/Plymouth



INSTALLATION-KIT1 ^{OS1}\$29.00/ea.
 Kit includes: 3 yards of burlap, 30 feet of paper coated listing wire, 2.5 yards of 2 inch wide felt & a dust mask.

HARDTOP AND CONVERTIBLE REAR SEATS All 1966-74 Dodge/Chrysler/Plymouth



INSTALLATION-KIT2 ^{OS1}\$279.00/ea.
 Kit includes: (1) 30"x70" 1 1/2" thick foam, (1) 10lb. roll of cotton, 4 yards of burlap, 12 feet of paper coated listing wire, 2 yards of muslin, (1) 3 1/2" x 64" Wire Edge Reinforced Burlap Cotton Support Band & a dust mask.

SPLIT BENCH & FULL BENCH FRONT SEATS All 1962-74 Dodge/Chrysler/Plymouth *With & Without Center Armrest



INSTALLATION-KIT4 ^{OS1}\$279.00/ea.
 Kit includes: (1) 30"x70" 1 1/2" thick foam, (1) 10lb. roll of cotton, 4 yards of burlap, 12 feet of paper coated listing wire, 2 yards of muslin, 3 yards of 2 inch wide felt, (1) 3 1/2" x 64" Wire Edge Reinforced Burlap Cotton Support Band & a dust mask.

BUCKET FRONT SEATS 1965 Coronet, 1966 Satellite, 1969 Sport Satellite, Roadrunner & GTX



INSTALLATION-KIT6\$100.00/ea.
 Kit includes: 1" thick foam (8) straight collar pieces

1969 Coronet



INSTALLATION-KIT7\$100.00/ea.
 Kit includes: 1" thick foam (2) horseshoe pieces & (4) straight collar pieces

BUCKET FRONT SEATS CONT. 1968 Sport Satellite, GTX, 1968-69 Charger



INSTALLATION-KIT11\$100.00/ea.
 Kit includes: (2) precut front seat bottom and (2) front seat top pieces of 1/2" high density upholstery foam

HARDTOP AND CONVERTIBLE REAR SEATS 1962-65 Dodge/Chrysler/Plymouth *With & Without Center Speaker Assembly



INSTALLATION-KIT12 ^{OS1}\$279.00/ea.
 Kit includes: (1) 30"x70" 1 1/2" thick foam, (1) 10lb. roll of cotton, 4 yards of burlap, 12 feet of paper coated listing wire, 2 yards of muslin, (1) 6" x 64" Wire Edge Reinforced Burlap Cotton Support Band & a dust mask.

HOG RING PLIER KITS

Standard Hog Ring Plier Kit

TAHOG\$15.00/ea.
 Kit contains pliers and enough hog rings for a front or rear installation only.

Deluxe Hog Ring Plier Kit

TAHOHVY\$39.00/ea.
 Kit contains heavy duty pliers and enough hog rings for a complete front and rear installation.

Hog Rings (Pkg/200)

TAHOGRING200\$ 5.00/pk.

INSTALLATION, FOAM & COTTON ACCESSORIES

Cotton Batting (1 Roll) ^{OS2}

TACOTTONROLL\$ 48.00/ea.
 1 Roll consists of 10 lbs.
 Must be used in conjunction with Legendary muslin.

Muslin (1 yard)

TAYDMUSLIN\$ 3.00/yd.
 Must be used in conjunction with Legendary cotton batting.

High Density Foam

TAFOAM1 (1.5" thick x 12" x 12")\$20.00/ea.
TAFOAM2 (1.5" thick x 24" x 24")\$38.00/ea.
TAFOAM3 (1.5" thick x 30" x 70") ^{OS1}\$82.00/ea.

Burlap (36" wide)

TABURLAP\$ 3.00/yd.

Paper Coated Wire

TAPAPERWIRE\$ 2.50/ft.



1960-65 B & C-BODY BUCKET SEAT FOAM



1960-65 molded foam for all B & C-Body models with bucket seats. Sets consist of a pair of (2) front seat tops and (2) front seat bottoms.

MF60ABCSET  \$329.00/set

- ☞ Requires minimal to moderate modification on some models during installation.
- ☞ Professional installation is highly recommended. Please see our installation services page located in the back of this catalog.
- ☞ Bucket seat foam will not work for Chrysler 300 rear bucket seats.

1966-67 B-BODY BUCKET SEAT FOAM



1966-67 molded foam for all B-Body models with bucket seats. Sets consist of a pair of (2) front seat tops and (2) front seat bottoms.

MF66ABSET  \$329.00/set

- ☞ Requires minimal to moderate modification on some models during installation.
- ☞ Professional installation is highly recommended. Please see our installation services page located in the back of this catalog.
- ☞ Bucket seat foam will not work for 1966-67 Charger rear bucket seats.

1968-69 B-BODY BUCKET SEAT FOAM



1968-69 molded foam for all B-Body models with bucket seats. Sets consist of a pair of (2) front seat tops and (2) front seat bottoms.

MF68ABSET  \$329.00/set

- ☞ Requires minimal to moderate modification on some models during installation.
- ☞ Professional installation is highly recommended. Please see our installation services page located in the back of this catalog.

1970-71 B-BODY BUCKET SEAT FOAM



1970-71 molded foam for the following **B-Body models** with high-back bucket seats. Sets consist of a pair of (2) front seat tops, (2) front seat bottoms and (2) headrest caps.

- 1970 'Cuda, Roadrunner, Sport Satellite, GTX & Superbird (vinyl style)
- 1970 Barracuda Gran Coupe (vinyl & cloth style)
- 1970-71 Duster (vinyl style)
- 1971 Demon
- 1971 Challenger (cloth style)

MF70ABESET  \$329.00/set

- ☞ Requires minimal to moderate modification on some models during installation.
- ☞ Professional installation is highly recommended. Please see our installation services page located in the back of this catalog.

Chrysler, Dodge, Plymouth

1970 B-BODY BUCKET SEAT FOAM



1970 molded foam for the 1970 Dodge Charger only. Sets consist of a pair of (2) front seat tops, (2) front seat bottoms

1970 Charger ONLY

MF70CXSET  \$369.00/set
 ☞ Requires minimal to moderate modification on some models during installation.
 ☞ Professional installation is highly recommended. Please see our installation services page located in the back of this catalog

1971-74 B-BODY BUCKET SEAT FOAM



1971-74 molded foam for the following **B-Body models** with high-back bucket seats. Sets consist of a pair of (2) front seat tops, (2) front seat bottoms

1971 Charger with Leather Buckets
 1971 & 1973-74 Charger with Cloth Buckets
 1972-74 Charger with Vinyl Buckets
 1973-74 Satellite/Roadrunner/GTX with Vinyl Buckets
 1974 Satellite/Roadrunner with Cloth Buckets

MF71CRXSET  \$369.00/set
 ☞ Requires minimal to moderate modification on some models during installation.
 ☞ Professional installation is highly recommended. Please see our installation services page located in the back of this catalog

1971-72 B-BODY BUCKET SEAT FOAM



PHOTO N/A
 AT TIME
 OF PRINTING

1971-72 molded foam for B-Body models with "pleated style" high-back bucket seats.. Sets consist of a pair of (2) front seat tops, (2) front seat bottoms.

1971-72 Roadrunner/Satellite Sebring Plus/GTX w/ vinyl bucket seats
 1971 Roadrunner/Satellite Sebring Plus/GTX w/ cloth bucket seats
 1971 Charger R/T/Charger 500/Superbee w/ vinyl bucket seats
 1971 Charger R/T/Charger 500/Superbee w/ cloth bucket seats

MF72CRXSET  \$369.00/set
 ☞ 1971 models used springs in the bucket seat top frame assemblies. These springs will need to be removed from the frames to accommodate the foam.
 ☞ Requires minimal to moderate modification on some models during installation.
 ☞ Professional installation is highly recommended. Please see our installation services page located in the back of this catalog

1963-69 A-100 VAN & SUPERSTOCK BUCKET SEAT FOAM

PHOTO N/A AT TIME OF PRINTING

Molded foam kit for 1963-69 A-100 Van, 1964,65 & 68 Super Stock. Sets consist of a pair of (2) front seat tops and (2) front seat bottoms.

MF64CSS  \$369.00/set
 ☞ Requires minimal to moderate modification on some models during installation.
 ☞ Professional installation is highly recommended. Please see our installation services page located in the back of this catalog.

1970 CORONET BUCKET SEAT BOTTOM FOAM





Molded foam bottom only for the 1970 Coronet bucket seats. Sets consist of a pair of (2) front seat bottoms.



MF70CWX-FSB \$179.00/set
 ☞ Requires minimal to moderate modification on some models during installation.
 ☞ Professional installation is highly recommended. Please see our installation services page located in the back of this catalog.





DOOR PANEL AND TRIM ACCESORIES

 facebook.com/legendaryautointeriors
 twitter.com/legendaryautoin

 www.legendaryautointeriors.com
 instagram.com/legendaryautointeriorsltd
 youtube.com/user/legendaryauto



**1963
to
1965**

PRE-ASSEMBLED DOOR PANELS

As original pre-assembled door panels for 1963-65 Chrysler B-Body cars. Available in factory correct grains and colors, these panels feature metal uppers with industry-first rolled ends to provide proper fit and durability. Inner window felts and door lock ferrules combine with correct cutouts and contours to deliver the quality you expect from Legendary!

www.legendaryautointeriors.com

1965 SATELLITE BUCKET STYLE

This Legendary product features as-original Die-electrically heat sealed Bison grain vinyl. Special cutout area in filler board to accommodate armrest base. Padded Multi-Level Construction 3-Dimensional Panel.



Grain

(C) COLOR CODES:

- (100) Black
- (315) Medium Metallic Blue (322) / Metallic Blue (314)
- (415) Dark Met Turquoise (414) / Metallic Turquoise (416)
- (535) Metallic Maroon (526) / Crimson Red (510)
- (625) Dark Metallic Gold (624) / Gold (614)

Bison

Front Panels (Unassembled).....	DO65CR00010(C)
100, 315, 415, 535.....	\$670/pr.
625.....	\$909/pr. (L4)

- ☞ Customer must reuse original metal trim.
- ☞ Require (16) door clips per panel.

Front Panels (Pre-assembled).....	DO65CR00010(C)-PA 
100, 315, 415, 535.....	\$891/pr.
625.....	\$1160/pr. (L4)

- ☞ Customer must reuse original metal trim.
- ☞ Require (16) door clips per panel.
- ☞ Includes original style upper metal rail & window felt strip.

Hardtop Rear Panels.....	DO65CR00040(C)
100, 315, 415, 535.....	\$294/pr.
625.....	\$468/pr. (L4)

- ☞ Customer must reuse original metal trim.
- ☞ Require (6) door clips per panel.

Convertible Rear Panels.....	DO65CR00050(C)
100, 315, 415, 535.....	\$252/pr.
625.....	\$374/pr. (L4)

- ☞ Customer must reuse original metal trim.
- ☞ Require (6) door clips per panel.

1966 SATELLITE BUCKET STYLE

This Legendary product features as-original Die-electrically heat sealed Cologne grain vinyl with detailed horizontal Western Scroll. Special cutout area in filler board to accommodate armrest base. Padded Multi-Level Construction 3-Dimensional Panel.

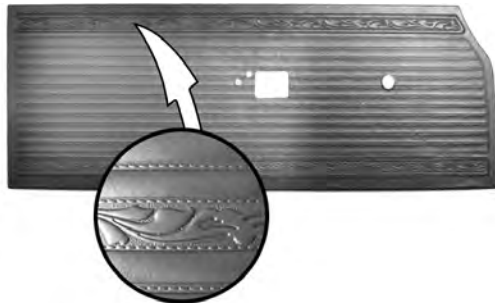
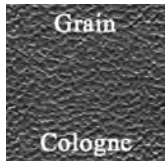

(C) COLOR CODES:

- (100) Black
- (318) Light Metallic Blue
- (420) Citron
- (520) Metallic Red
- (614) Gold (Requires Sample Approval)

Front Panels.....	DO66CR00010(C)
(All colors).....	\$439/pr.
☞ Require (13) door clips per panel.	

Hardtop Rear Panels.....	DO66CR00040(C)
(All colors).....	\$252/pr.
☞ Require (3) door clips per panel.	

Convertible Rear Panels.....	DO66CR00050(C)
(All colors).....	\$159/pr.
☞ Require (3) door clips per panel.	

1965 BELVEDERE II BENCH STYLE

This Legendary product features as-original Die-electrically heat sealed Cologne grain vinyl with Bison grain upper insert. Special cutout area in filler board to accommodate armrest base. Padded Multi-Level Construction 3-Dimensional Panel.



Grain

Cologne

Grain

(C) COLOR CODES:

- (100) Black
- (334) Metallic Navy (320) / Metallic Blue (314)
- (415) Dark Met Turquoise (414) / Metallic Turquoise (416)
- (535) Metallic Maroon (536) / Crimson Red (510)
- (625) Dark Metallic Gold (624) / Gold (614)
- (692) Dark Brown (612) / Metallic Fawn (610)

Bison

Front Panels (Unassembled).....	DO65CR20012(C)
100, 334, 415, 535.....	\$670/pr.
625, 692.....	\$793/pr. (L4)

- ☞ Customer must reuse original metal trim.
- ☞ Require (16) door clips per panel.

Front Panels (Pre-assembled).....	DO65CR20012(C)-PA 
100, 334, 415, 535.....	\$891/pr.
625, 692.....	\$1004/pr. (L4)

- ☞ Customer must reuse original metal trim.
- ☞ Require (16) door clips per panel.
- ☞ Includes original style upper metal rail & window felt strip.

Hardtop Rear Panels.....	DO65CR20048(C)
100, 334, 415, 535.....	\$294/pr.
625, 692.....	\$401/pr. (L4)

- ☞ Customer must reuse original metal trim.
- ☞ Require (6) door clips per panel.

Convertible Rear Panels.....	DO65CR20056(C)
100, 334, 415, 535.....	\$252/pr.
614.....	\$351/pr. (L1)

- ☞ Customer must reuse original metal trim.
- ☞ Require (6) door clips per panel.

1966 BELVEDERE II BENCH STYLE

This Legendary product features as-original Die-electrically heat sealed Cologne grain vinyl with Crater grain insert. Special cutout area in filler board to accommodate armrest base. Padded Multi-Level Construction 3-Dimensional Panel.



(C) COLOR CODES:

- (100) Black
- (327) Metallic Navy (320) / Light Metallic Blue (318)
- (415) Dark Met Turquoise (414) / Metallic Turquoise (416)
- (429) Medium Metallic Green (440) / Citron (420)
- (520) Metallic Red
- (619) Gold (614) (Requires Sample Approval) / Light Gold (618)

Front Panels.....	DO66CR00020(C)
100, 327, 415, 429, 520.....	\$459/pr.
619.....	\$625/pr. (L1)
☞ Require (13) door clips per panel.	

Hardtop Rear Panels.....	DO66CR00080(C)
100, 327, 415, 429, 520.....	\$263/pr.
619.....	\$372/pr. (L1)
☞ Require (3) door clips per panel.	

Convertible Rear Panels.....	DO66CR00060(C)
100, 327, 415, 429, 520.....	\$168/pr.
619.....	\$247/pr. (L1)
☞ Require (3) door clips per panel.	

1967 SATELLITE & GTX BUCKET STYLE

This Legendary product features as-original Die-electrically heat sealed Cologne grain vinyl with detailed vertical Western Scroll. Special cutout area in filler board to accommodate armrest base. Padded Multi-Level Construction 3-Dimensional Panel.

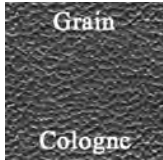

(C) COLOR CODES:

- (100) Black
- (202) Pearl White
- (320) Metallic Navy
- (520) Metallic Red
- (620) Copper

Front Panels **DO67CR00010(C)**
(All colors)..... \$439/pr.
Ⓢ Require (13) door clips per panel.

Hardtop Rear Panels **DO67CR00040(C)**
(All colors)..... \$252/pr.
Ⓢ Require (3) door clips per panel.

Convertible Rear Panels..... **DO67CR00050(C)**
(All colors)..... \$159/pr.
Ⓢ Require (3) door clips per panel.

1967 BELVEDERE II BENCH STYLE

This Legendary product features as-original Die-electrically heat sealed Cologne grain vinyl with Bambino grain insert. Special cutout area in filler board to accommodate armrest base. Padded Multi-Level Construction 3-Dimensional Panel.

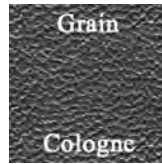
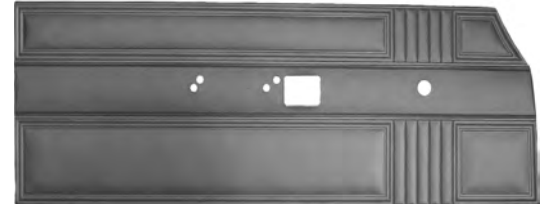

(C) COLOR CODES:

- (100) Black
- (202) Pearl White
- (327) Metallic Navy (320) / Light Metallic Blue (318)
- (415) Dark Met Turquoise (414) / Metallic Turquoise (416)
- (520) Metallic Red
- (623) Dark Brown (622) / Light Gold (618)
- (627) Dark Copper (626) / Copper (620)

Front Panels **DO67CR20020(C)**
100, 202, 327, 415, 520..... \$439/pr.
627..... \$609/pr. (L1)
623..... \$695/pr. (L1)
Ⓢ Require (13) door clips per panel.

Hardtop Rear Panels **DO67CR20080(C)**
100, 327, 415, 520..... \$252/pr.
627..... \$360/pr. (L1)
623..... \$428/pr. (L1)
Ⓢ Require (3) door clips per panel.

Convertible Rear Panels..... **DO67CR20060(C)**
100, 202, 327, 520..... \$159/pr.
627..... \$238/pr. (L1)
Ⓢ Require (3) door clips per panel.

1967 BELVEDERE II "SILVER SPECIAL" BENCH STYLE

This Legendary product features as-original Die-electrically heat sealed Cologne grain vinyl with Boar grain insert. Special cutout area in filler board to accommodate armrest base. Padded Multi-Level Construction 3-Dimensional Panel.

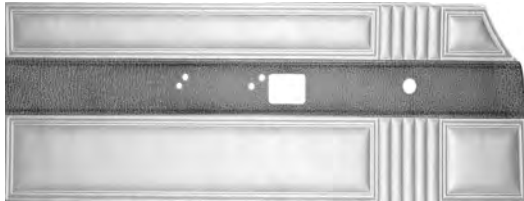

(C) COLOR CODES:

- (107) Black with Silver Cast (106) / Silver (102)

Front Panels **DO67CRBR020(C)**
107..... \$625/pr.
Ⓢ Require (13) door clips per panel.

Hardtop Rear Panels **DO67CRBR080(C)**
107..... \$331/pr.
Ⓢ Require (3) door clips per panel.

1968 SPORT SATELLITE & GTX BUCKET STYLE

This Legendary product features as-original Die-electrically heat sealed Cologne grain vinyl with woodgrain center. Special cutout area in filler board to accommodate armrest base. Padded Multi-Level Construction 3-Dimensional Panel.

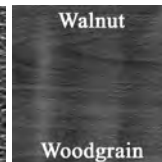
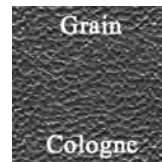
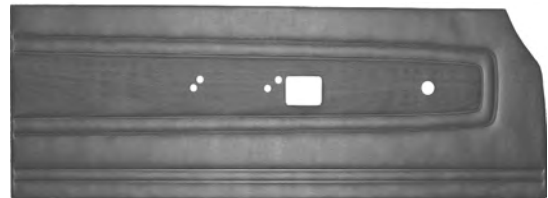

(C) COLOR CODES:

- (100) Black
- (202) Pearl White
- (332) Light Metallic Blue
- (430) Dark Metallic Green
- (526) Metallic Maroon
- (630) Gold

Front Panels **DO68CR00010(C)**
(All colors)..... \$459/pr.
Ⓢ Customer must reuse original metal trim.
Ⓢ Require (13) door clips per panel.

Hardtop Rear Panels **DO68CR00040(C)**
(All colors)..... \$263/pr.
Ⓢ Require (3) door clips per panel.

Convertible Rear Panels..... **DO68CR00050(C)**
100, 202, 332,
430, 526..... \$168/pr.
Ⓢ Require (3) door clips per panel.
Ⓢ 630 Gold not available for convertible models.



1968 SATELLITE & ROADRUNNER "DECOR" BENCH STYLE

This Legendary product features as-original Die-electrically heat sealed Cologne grain vinyl. Special cutout area in filler board to accommodate armrest base. Padded Multi-Level Construction 3-Dimensional Panel.

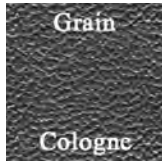
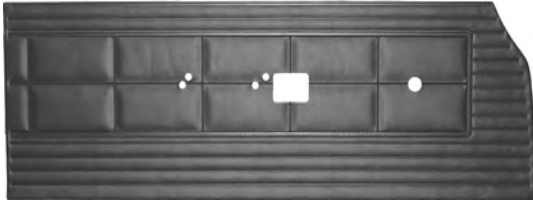

(C) COLOR CODES:

- (100) Black
- (202) Pearl White
- (233) Metallic Parchment (230) / Gold (630)
- (359) Dark Metallic Blue (330) / Light Metallic Blue (332)
- (457) Dark Metallic Green (430) / Light Metallic Green (432)
- (529) Metallic Maroon (526) / Metallic Red (520)

Front Panels **DO68CRP0020(C)**
 100, 202, 359, 457, 529.....\$459/pr.
 233.....\$627/pr. (L1)

☞ Require (13) door clips per panel.

Hardtop Rear Panels **DO68CRP0080(C)**
 100, 202, 359, 457, 529.....\$263/pr.
 233.....\$360/pr. (L1)

☞ Require (3) door clips per panel.

Convertible Rear Panels..... **DO68CRP0060(C)**
 100, 359, 457, 529.....\$168/pr.

☞ Require (3) door clips per panel.

1968 BELVEDERE & ROADRUNNER DELUXE & STANDARD BENCH STYLE

This Legendary product features as-original Die-electrically heat sealed Cologne grain vinyl with Reed grain insert. Special cutout area in filler board to accommodate armrest base. Padded Multi-Level Construction 3-Dimensional Panel.

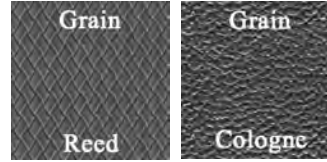

(C) COLOR CODES:

- (100) **Black
- (102) Silver
- (105) **Black (100) / Silver (102)
- (220) Oyster
- (330) Dark Metallic Blue

Front Panels **DO68CRWE020(C)**
 100, 102, 105, 330.....\$459/pr. (L1)
 220.....\$695/pr.

☞ Require (13) door clips per panel.

Hardtop Rear Panels **DO68CRWE080(C)**
 100, 102, 105, 330.....\$263/pr.
 220.....\$428/pr. (L1)

☞ Require (3) door clips per panel.

** (100) BLACK AND (105) BLACK/SILVER WERE NOT OFFERED IN 1968 CORONET DELUXE MODELS, BUT MAY BE PURCHASED AS A SPECIAL ORDER. AVAILABLE ONLY AS A PREPAID, NON-REFUNDABLE AND NON-RETURNABLE.

1969 SPORT SATELLITE & GTX BUCKET STYLE

This Legendary product features as-original Die-electrically heat sealed Coachman grain vinyl with woodgrain and chrome accent strip. Special cutout area in filler board to accommodate armrest base. Padded Multi-Level Construction 3-Dimensional Panel.

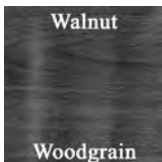

(C) COLOR CODES:

- (100) Black
- (130) Pewter
- (200) White
- (330) Dark Metallic Blue
- (434) Dark Metallic Green
- (528) Red
- (650) Saddle



Front Panels **DO69CR00010(C)**
 (All colors).....\$459/pr.

☞ Require (13) door clips per panel.

Hardtop Rear Panels **DO69CR00040(C)**
 (All colors).....\$263/pr.

☞ Require (3) door clips per panel.

Convertible Rear Panels..... **DO69CR00050(C)**
 100, 200, 330, 650.....\$168/pr.

☞ Require (3) door clips per panel.

1969 SATELLITE & ROADRUNNER BUCKET & "DECOR" BENCH STYLE

This Legendary product features as-original Die-electrically heat sealed Coachman grain vinyl with Ascot grain center panel. Special cutout area in filler board to accommodate armrest base. Padded Multi-Level Construction 3-Dimensional Panel.

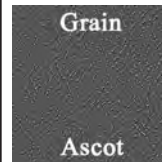

(C) COLOR CODES:

- (100) Black
- (130) Pewter
- (200) White
- (351) Light Metallic Blue (332) / Dark Metallic Blue (330)
- (359) Dark Metallic Blue (330) / Light Metallic Blue (332)
- (435) Light Metallic Green (432) / Dark Metallic Green (434)
- (437) Dark Metallic Green (434) / Light Metallic Green (432)
- (651) Bronze (640) / Saddle (650)
- (653) Saddle (650) / Bronze (640)

Front Panels **DO69CRP0012(C)**
 (All colors).....\$459/pr.

☞ Require (13) door clips per panel.

Hardtop Rear Panels **DO69CRP0048(C)**
 (All colors).....\$263/pr.

☞ Require (3) door clips per panel.

Convertible Rear Panels..... **DO69CRP0056(C)**
 100, 200, 351, 651.....\$168/pr.

1969 BELVEDERE & ROADRUNNER DELUXE & STANDARD BENCH STYLE

This Legendary product features as-original Die-electrically heat sealed Coachman grain vinyl with Reed grain insert. Special cutout area in filler board to accommodate armrest base. Padded Multi-Level Construction 3-Dimensional Panel.



(C) COLOR CODES:
(100) Black
(332) Light Metallic Blue
(650) Saddle

Front Panels **DO69CRE0020(C)**
(All colors)..... \$458/pr.
Ⓢ Require (13) door clips per panel.

Hardtop Rear Panels **DO69CRE0080(C)**
(All colors)..... \$251/pr.
Ⓢ Require (3) door clips per panel.

1970 SATELLITE, ROADRUNNER & SUPERBIRD DELUXE BENCH STYLE

This Legendary product features as-original Die-electrically heat sealed Coachman grain vinyl with Belmont grain accent band. Special cutout area in filler board to accommodate armrest base. Padded Multi-Level Construction 3-Dimensional Panel.



(C) COLOR CODES:
(103) Black (100) w/ Silver (104) Accent
(200) White w/ White Accent
(367) Bright Blue (338) w/ Dark Metallic Blue (330) Accent
(443) Dark Metallic Green (434) w/ Light Metallic Green (432) Accent
(540) Burnt Orange w/ Burnt Orange Accent
(663) Brown (656) w/ Dark Brown (664) Accent
Front Panels **DO70CRD0020(C)**
(All colors)..... \$459/pr.
Ⓢ Require (13) door clips per panel.

Hardtop Rear Panels **DO70CRD0080(C)**
(All colors)..... \$263/pr.
Ⓢ Require (3) door clips per panel.

Convertible Rear Panels..... **DO70CRD0060(C)**
103, 200, 367, 540..... \$168/pr.
Ⓢ Not for Superbird models.
Ⓢ Require (3) door clips per panel.

1970 SPORT SATELLITE, ROADRUNNER, GTX & SUPERBIRD BUCKET & CLOTH BENCH STYLE

This Legendary product features as-original Die-electrically heat sealed Coachman grain vinyl with embossed extruded welt. Special cutout area in filler board to accommodate armrest base. Padded Multi-Level Construction 3-Dimensional Panel.



(C) COLOR CODES:
(100) Black w/ Black welt
(115) Black (100) w/ Silver (104) welt
(163) Charcoal (154) w/ Silver (104) welt
(200) White w/ White welt
(363) Bright Blue (338) w/ White (200) welt
(439) Dark Metallic Green (434) w/ Lt Met Green (432) welt
(544) Burnt Orange (540) w/ Bright Orange (560) welt
(655) Brown (656) w/ Dark Brown (664) welt
(669) Gold (660) w/ Black (100) welt

Front Panels **DO70CR00010(C)**
100, 115, 163, 200, 363, 439, 544, 655 \$459/pr.
669..... \$761/pr. (L1)
Ⓢ Require (13) door clips per panel.

Hardtop Rear Panels **DO70CR00040(C)**
100, 115, 163, 200, 363, 439, 544, 655 \$263/pr.
669..... \$460/pr. (L1)
Ⓢ Require (3) door clips per panel.

Convertible Rear Panels..... **DO70CR00050(C)**
100, 115, 163, 200, 363, 544 \$168/pr.
Ⓢ Not for Superbird, GTX and Sport Satellite
Ⓢ Require (3) door clips per panel.

1971 SATELLITE, ROADRUNNER & GTX BUCKET STYLE

This Legendary product features as-original Die-electrically heat sealed El Paso grain vinyl with woodgrain lower and knurled black center chrome accent. Cutout area in filler board to accommodate armrest base. Padded Multi-Level Construction 3-Dimensional Panel.

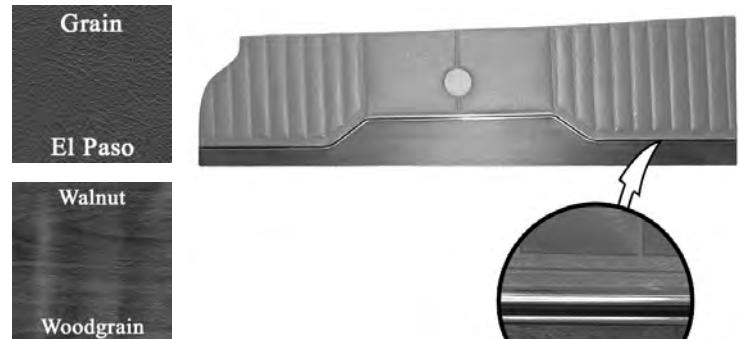

(C) COLOR CODES:
(100) Black (452) Dk Met Green
(140) Gunmetal (664) Brown
(200) White (666) Ember Gold
(340) Bright Blue

Upper Front Panels (Vinyl) **DO71CR00012(C)**
(All colors)..... \$459/pr.
Ⓢ Require (8) door clips per panel.

Upper Rear Panels (Vinyl)..... **DO71CR00048(C)**
(All colors)..... \$263/pr.
Ⓢ Require (3) door clips per panel.
Ⓢ Professional installation recommended.



**1971 SATELLITE,
ROADRUNNER & GTX
STANDARD BENCH STYLE**

This Legendary product features as-original Die-electrically heat sealed Double Stitched rib grain vinyl.



(C) COLOR CODES:

- (100) Black
- (340) Bright Blue
- (664) Brown

Upper Front Panels (Vinyl) **DO71CRS0020(C)**
 (All colors)..... \$422/pr.
 ☞ Require (8) door clips per panel.

Upper Rear Panels (Vinyl)..... **DO71CRS0080(C)**
 (All colors)..... \$218/pr.
 ☞ Require (3) door clips per panel.
 ☞ Professional installation recommended.

**1971 SATELLITE
& ROADRUNNER
BUCKET & DELUXE BENCH STYLE**

This Legendary product features as-original Die-electrically heat sealed Coachman grain inserts and chrome accents. Special cutout area in filler board to accommodate armrest base. Padded Multi-Level Construction 3-Dimensional Panel.



(C) COLOR CODES:

- (116) White (200) w/ Black (100) Insert
- (141) Gunmetal (140) w/ Black (100) Insert
- (155) Black (100) w/ Charcoal (156) Insert (Requires Sample Approval)
- (332) Light Metallic Blue w/ Light Metallic Blue Insert
- (340) Bright Blue w/ Bright Blue Insert
- (451) Dark Metallic Green (432) w/ Light Metallic Green (452) Insert
- (665) Brown (668) w/ Tan (664) Insert
- (666) Ember Gold w/ Ember Gold Insert

Upper Front Panels (Vinyl) **DO71CRD0012(C)**
 (All colors)..... \$459/pr.
 ☞ Require (8) door clips per panel.

Upper Rear Panels (Vinyl)..... **DO71CRD0048(C)**
 (All colors)..... \$263/pr.
 ☞ Require (3) door clips per panel.
 ☞ Professional installation recommended.

**1972 SATELLITE
& ROADRUNNER
STANDARD BENCH STYLE**

This Legendary product features as-original Die-electrically heat sealed 1/4 rib grain vinyl.



(C) COLOR CODES:

- (100) Black
- (340) Bright Blue
- (444) Dark Green

Upper Front Panels (Vinyl) **DO72CRS0020(C)**
 (All colors)..... \$421/pr.
 ☞ Require (8) door clips per panel.

Upper Rear Panels (Vinyl)..... **DO72CRS0080(C)**
 (All colors)..... \$218/pr.
 ☞ Require (3) door clips per panel.
 ☞ Professional installation recommended.

1972 SATELLITE & ROADRUNNER BUCKET STYLE

This Legendary product features as-original Die-electrically heat sealed Coachman grain upper, woodgrain and chrome accent. Special cutout area in filler board to accommodate armrest base. Padded Multi-Level Construction 3-Dimensional Panel.

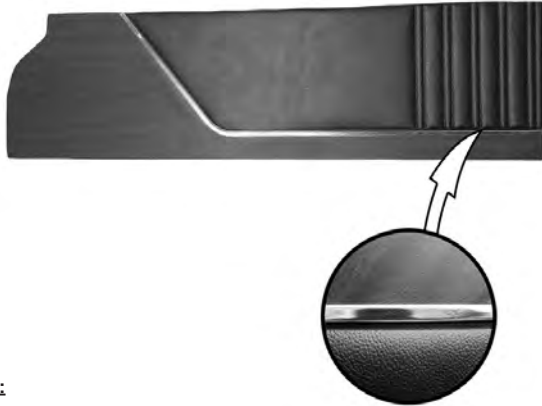
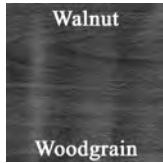

(C) COLOR CODES:

- (100) Black
- (200) White
- (340) Bright Blue
- (444) Dark Green
- (666) Ember Gold

Upper Front Panels (Vinyl) **DO72CR00010(C)**
 (All colors)..... \$459/pr.
 ☞ Require (8) door clips per panel.

Upper Rear Panels (Vinyl)..... **DO72CR00040(C)**
 (All colors)..... \$263/pr.
 ☞ Require (3) door clips per panel.
 ☞ Professional insallation recommended.

1973 SATELLITE & ROADRUNNER BUCKET & CLOTH BENCH STYLE

This Legendary product features as-original Die-electrically heat sealed Cologne or Coachman grain upper, woodgrain and chrome accent. Special cutout area in filler board to accommodate armrest base. Padded Multi-Level Construction 3-Dimensional Panel.

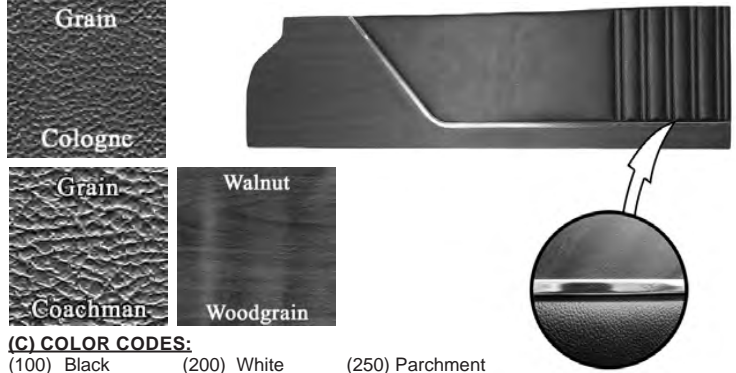

(C) COLOR CODES:

- (100) Black
- (200) White
- (250) Parchment
- (340) Bright Blue
- (444) Dark Green
- (671) Honey Gold (Requires Sample Approval)
- (672) Honey Gold

Upper Front Panels (Vinyl) (Cologne) **DO73CR00010(C)**
 Upper Front Panels (Vinyl) (Coachman) **DO73CR00020(C)**
 100, 200, 250, 340, 444, 671..... \$459/pr.
 672..... \$625/pr. (L1)

☞ #200 White was not available on cloth bench style models.
 ☞ Specify Cologne or Coachman grain at time of order.
 ☞ Require (8) door clips per panel.

Upper Rear Panels (Vinyl) (Cologne)..... **DO73CR00040(C)**
 Upper Rear Panels (Vinyl) (Coachman) **DO73CR00080(C)**
 100, 200, 340, 444, 671..... \$263/pr.
 672..... \$372/pr. (L1)

☞ #200 White was not available on cloth bench style models.
 ☞ Specify Cologne or Coachman grain at time of order.
 ☞ Require (3) door clips per panel.
 ☞ Professional insallation recommended.

1973 SATELLITE & ROADRUNNER BUCKET & DELUXE BENCH STYLE

This Legendary product features as-original Die-electrically heat sealed Coachman grain vinyl with knurled chrome accent. Special cutout area in filler board to accommodate armrest base. Padded Multi-Level Construction 3-Dimensional Panel.

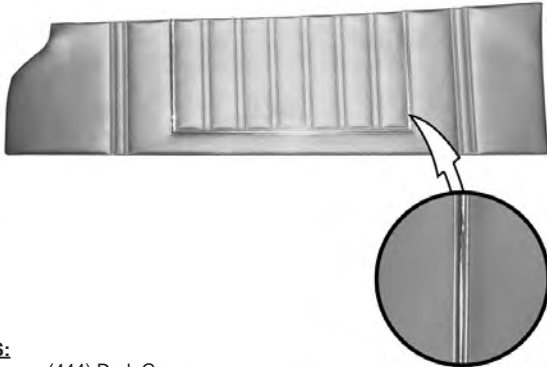

(C) COLOR CODES:

- (100) Black
- (200) White
- (250) Parchment
- (340) Bright Blue
- (444) Dark Green
- (671) Honey Gold
- (672) Honey Gold
- (Requires Sample Approval)

Upper Front Panels (Vinyl) **DO73CRD0020(C)**
 100, 200, 250, 340, 444, 671..... \$459/pr.
 672..... \$654/pr. (L1)
 ☞ Require (8) door clips per panel.

Upper Rear Panels (Vinyl)..... **DO73CRD0080(C)**
 100, 200, 250, 340, 444, 671..... \$263/pr.
 672..... \$395/pr. (L1)
 ☞ Require (3) door clips per panel.
 ☞ Professional insallation recommended.



1968-70 CHARGER PADDED DOOR UPPERS



- Manufactured by Legendary
- Perfect Front to Rear Alignment
- Stamped Metal Parts with Correct Door Panel Clip Hole Placement
- Solid Vinyl Material (Not Painted)
- As Original Contours & Features
- Guaranteed Fit and Quality
- Limited Lifetime Warranty
- Factory Colors & Grains
- Original Factory Look
- Complete set includes door lock ferrules, medallions and inner window fuzzies only

1968 Charger

Complete Set.....**DO68CXU(C)SET**
(All colors).....\$1300/pr. (L5)

☞ Door lock ferrules, medallions and inner window sweeps included in complete set only
☞ Door panel clips are sold separately

Front Panels**DO68CXU0010(C)**
(All colors).....\$595/pr. (L5)

Rear Panels.....**DO68CXU0040(C)**
(All colors).....\$534/pr. (L5)

☞ Colors 332, 430, 520 & 636 are not available at this time.

1969 Charger

Complete Set.....**DO69CXU(C)SET**
(All colors).....\$1300/pr. (L5)

☞ Door lock ferrules, medallions and inner window sweeps included in complete set only
☞ Door panel clips are sold separately

Front Panels**DO69CXU0010(C)**
(All colors).....\$595/pr. (L5)

Rear Panels.....**DO69CXU0040(C)**
(All colors).....\$534/pr. (L5)

☞ Color 528 is not available at this time.

1970 Charger

Complete Set.....**DO70CXU(C)SET**
(All colors).....\$1300/pr. (L5)

☞ Door lock ferrules, medallions and inner window sweeps included in complete set only
☞ Door panel clips are sold separately

Front Panels**DO70CXU0010(C)**
(All colors).....\$595/pr. (L5)

Rear Panels.....**DO70CXU0040(C)**
(All colors).....\$534/pr. (L5)

☞ Colors 338, 540 & 656 are not available at this time.

(C) COLOR CODES:

- (100) Black (1968-70)
- (154) Charcoal (1970)
- (200) White (1969-70)
- (202) Pearl White (1968)
- (330) Dark Met. Blue (1969)
- (434) Dark Met. Green (1969-70)
- (650) Saddle (1969)
- (670) "Dukes" Tan (1969)

UPPER DOOR PANEL EMBLEMS

1968-69 Charger

DP68CX-EMBLEM..... \$49/ea.

1970 Charger

DP70CX-EMBLEM..... \$49/ea.

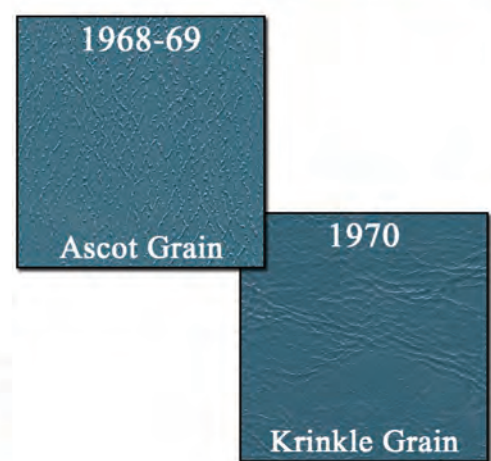
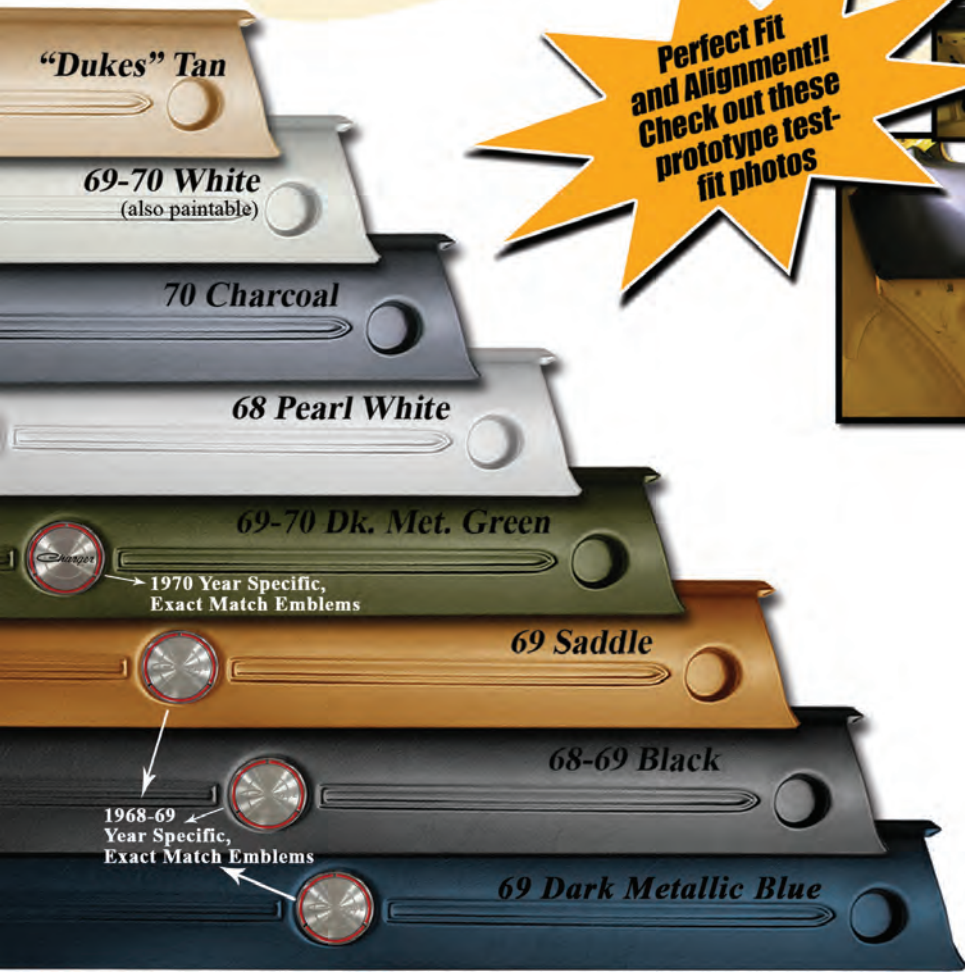
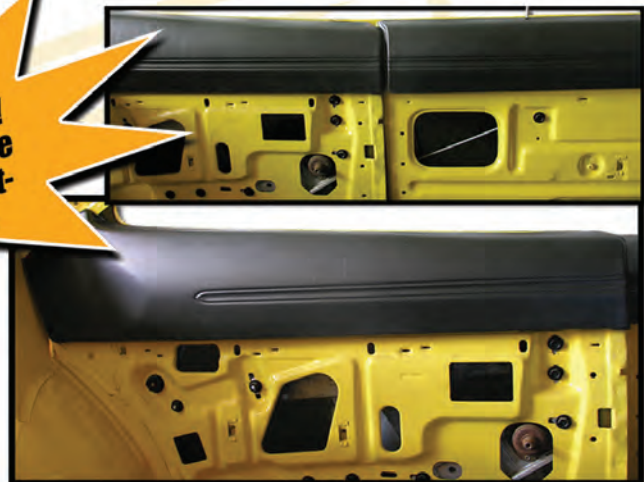

1970 Year Specific, Exact Match Emblems

1968-69 Year Specific, Exact Match Emblems

1968 CHARGER R/T & CHARGER BUCKET STYLE

This Legendary product features as-original Die-electrically heat sealed Cologne grain vinyl with map pocket. Special cutout area in filler board to accommodate armrest base. Padded Multi-Level Construction 3-Dimensional Panel.

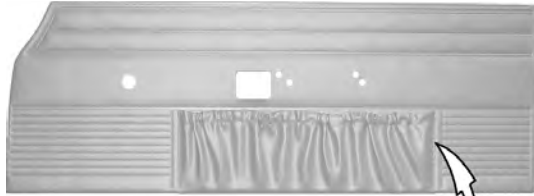
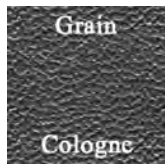

(C) COLOR CODES:

- (100) Black
- (202) Pearl White
- (332) Light Metallic Blue
- (357) Light Metallic Blue (332) / Met. Navy (320)
- (430) Dark Metallic Green
- (520) Metallic Red
- (527) Metallic Red (520) / Metallic Maroon (526)
- (636) Ember Gold

Front Panels **DO68CX00010(C)**
 (All colors)..... \$492/pr.

- ☞ Require (13) door clips per panel.
- ☞ Map pocket buttons are discontinued

Rear Panels **DO68CX00040(C)**
 (All colors)..... \$252/pr.

- ☞ Require (3) door clips per panel.

1969 CHARGER, CHARGER R/T, SE, 500 & DAYTONA BUCKET STYLE

This Legendary product features as-original Die-electrically heat sealed Coachman grain vinyl with map pocket. Special cutout area in filler board to accommodate armrest base. Padded Multi-Level Construction 3-Dimensional Panel.

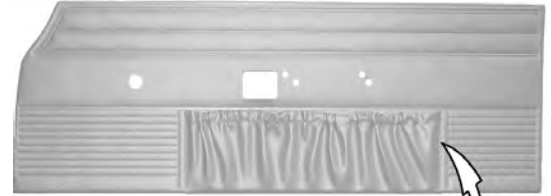

(C) COLOR CODES:

- (100) Black
- (200) White
- (330) Dark Metallic Blue
- (434) Dark Metallic Gre
- (528) Red
- (650) Saddle

Front Panels **DO69CX00010(C)**
 (All colors)..... \$492/pr.

- ☞ Require (13) door clips per panel.
- ☞ Map pocket buttons are discontinued.

Rear Panels **DO69CX00040(C)**
 (All colors)..... \$252/pr.

- ☞ Require (3) door clips per panel.

1969 CHARGER "DUKES OF HAZZARD" LEGENDARY AUTO INTERIORS, LTD. EXCLUSIVE

This Legendary product features as-original Die-electrically heat sealed Coachman grain vinyl with map pocket. Special cutout area in filler board to accommodate armrest base. Padded Multi-Level Construction 3-Dimensional Panel.



(C) COLOR CODES:
 (670) "Dukes" Tan



Front Panels **DO69CX00010(C)**
 *670 \$524/pr.

- ☞ Require (13) door clips per panel.
- ☞ Map pocket buttons are discontinued.

Rear Panels **DO69CX00040(C)**
 *670 \$273/pr.

- ☞ Require (3) door clips per panel.

*TAN WAS NOT OFFERED AS AN ORIGINAL COLOR IN 1969 CHARGER MODELS, BUT MAY BE PURCHASED AS A SPECIAL ORDER. AVAILABLE ONLY AS A PREPAID, NON-REFUNDABLE AND NON-RETURNABLE ORDER WITH OUR (5) YEAR FACTORY WARRANTY.



**1970 CHARGER R/T, 500
& CHARGER
STANDARD BUCKET
& BENCH STYLE**

This Legendary product features as-original Die-electrically heat sealed Krinkle grain vinyl with Diamond Basketweave insert and chrome accent. Special cutout area in filler board to accommodate armrest base. Padded Multi-Level Construction 3-Dimensional Panel.

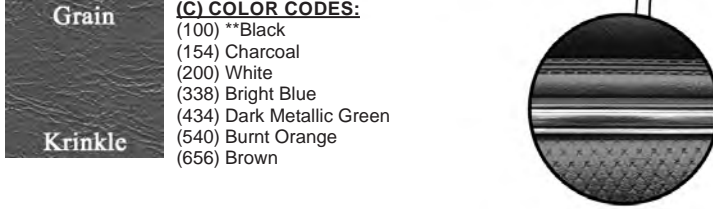
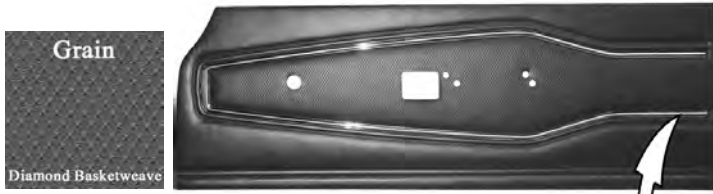

- (C) COLOR CODES:**
 (100) **Black
 (154) Charcoal
 (200) White
 (338) Bright Blue
 (434) Dark Metallic Green
 (540) Burnt Orange
 (656) Brown

Front Panels **DO70CX0012(C)**
 (All colors)..... \$459/pr.
 ⚠ Require (13) door clips per panel.

Rear Panels **DO70CX0048(C)**
 (All colors)..... \$263/pr.
 ⚠ Require (3) door clips per panel.

****BLACK WAS NOT OFFERED IN 1970 CHARGER MODELS, BUT MAY BE PURCHASED AS A SPECIAL ORDER. AVAILABLE ONLY AS A PREPAID, NON-REFUNDABLE AND NON-RETURNABLE ORDER.**

**1970 CHARGER R/T SE
DELUXE BUCKET & BENCH STYLE**

This Legendary product features as-original Die-electrically heat sealed Krinkle grain with map pocket and woodgrain accents. Special cutout area in filler board to accommodate armrest base. Padded Multi-Level Construction 3-Dimensional Panel.



- (C) COLOR CODES**
 (100) Black
 (154) Charcoal
 (338) Bright Blue
 (434) Dark Metallic Green
 (656) Brown

Front Panels **DO70CXD0012(C)**
 (All colors)..... \$511/pr.
 ⚠ Customer must reuse original metal trim.
 ⚠ Require (13) door clips per panel.

Rear Panels **DO70CXD0048(C)**
 (All colors)..... \$263/pr.
 ⚠ Require (3) door clips per panel

**1971 CHARGER R/T
& CHARGER 500
BUCKET & BENCH STYLE**

This Legendary product features as-original Die-electrically heat sealed Coachman grain vinyl with woodgrain and chrome accent. Special cutout area in filler board to accommodate armrest base. Padded Multi-Level Construction 3-Dimensional Panel.



- (C) COLOR CODES:**
 (100) Black
 (140) Gunmetal
 (200) White
 (340) Bright Blue
 (452) Dark Metallic Green
 (664) Brown
 (666) Ember Gold

Upper Front Panels (Vinyl) **DO71CXP0012(C)**
 (All colors)..... \$459/pr.
 ⚠ Require (8) door clips per panel.

Upper Rear Panels (Vinyl)..... **DO71CXP0048(C)**
 (All colors)..... \$263/pr.
 ⚠ Require (3) door clips per panel
 ⚠ Professional installation recommended.

**1971 SUPERBEE
BUCKET & BENCH STYLE**

This Legendary product features as-original Die-electrically heat sealed Coachman grain vinyl with woodgrain and chrome accent. Special cutout area in filler board to accommodate armrest base. Padded Multi-Level Construction 3-Dimensional Panel.



- (C) COLOR CODES:**
 (100) Black
 (140) Gunmetal
 (200) White
 (340) Bright Blue
 (452) Dark Metallic Green
 (664) Brown
 (666) Ember Gold

Upper Front Panels (Vinyl) **DO71CX00012(C)**
 (All colors)..... \$459/pr.
 ⚠ Require (8) door clips per panel.

Upper Rear Panels (Vinyl)..... **DO71CXP0048(C)**
 (All colors)..... \$263/pr.
 ⚠ Require (3) door clips per panel
 ⚠ Professional installation recommended.

1971 CHARGER SE BUCKET & BENCH STYLE

This Legendary product features as-original Die-electrically heat sealed Belmont grain pil-
lowed center and chrome double hump woodgrained center accent welt. Cutout area in filler
board to accommodate armrest base. Padded Multi-Level Construction 3-Dimensional Panel.

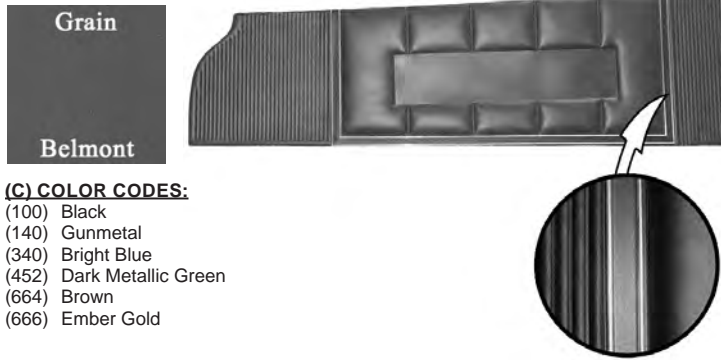

Upper Front Panels (Vinyl) DO71CXB0012(C)
 (All colors).....\$501/pr.
 ⚠ Require (8) door clips per panel.

Upper Rear Panels (Vinyl)..... DO71CXB0048(C)
 (All colors).....\$277/pr.
 ⚠ Require (3) door clips per panel
 ⚠ Professional insallation recommended.

1972 CHARGER STANDARD BENCH STYLE

This Legendary product features as-original Die-electrically heat sealed Coachman grain
upper and Ranger grain lower with chrome center accent. Special cutout area in filler board
to accommodate armrest base. Padded Multi-Level Construction 3-Dimensional Panel.

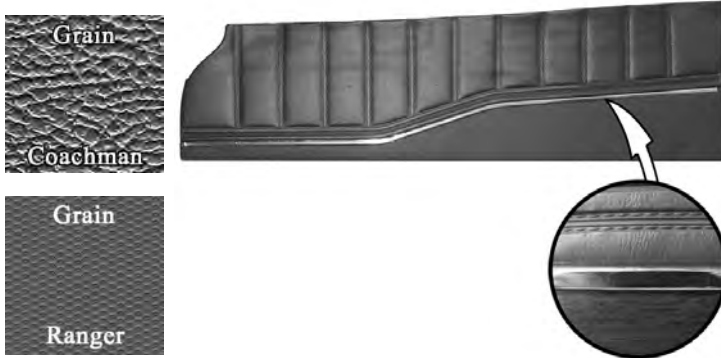

Upper Front Panels (Vinyl) DO72CX00020(C)
 (All colors).....\$459/pr.
 ⚠ Require (8) door clips per panel.

Upper Rear Panels (Vinyl)..... DO72CX00080(C)
 (All colors).....\$263/pr.
 ⚠ Require (3) door clips per panel.
 ⚠ Professional insallation recommended.

1972 CHARGER SE & CHARGER BUCKET & DELUXE BENCH STYLE

This Legendary product features as-original Die-electrically heat sealed Cologne grain
upper with woodgrain lower and chrome center accent. Special cutout area in filler board
to accommodate armrest base. Padded Multi-Level Construction 3-Dimensional Panel.

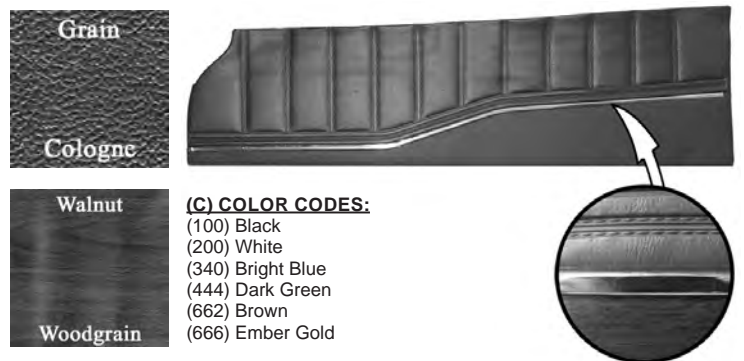

Upper Front Panels (Vinyl) DO72CX00012(C)
 (All colors).....\$459/pr.
 ⚠ Require (8) door clips per panel.

Upper Rear Panels (Vinyl)..... DO72CX00048(C)
 (All colors).....\$263/pr.
 ⚠ Require (3) door clips per panel.
 ⚠ Professional insallation recommended.



1973 CHARGER STANDARD BENCH STYLE

This Legendary product features as-original Die-electrically heat sealed Coachman grain upper and Empire grain lower with chrome center accent. Special cutout area in filler board to accommodate armrest base. Padded Multi-Level Construction 3-Dimensional Panel.



(C) COLOR CODES:

- (100) Black
- (340) Bright Blue
- (444) Dark Green

Upper Front Panels (Vinyl) **DO73CX00028(C)**
 (All colors)..... \$459/pr.
 ☞ Require (8) door clips per panel.

Upper Rear Panels (Vinyl)..... **DO73CX00088(C)**
 (All colors)..... \$263/pr.
 ☞ Require (3) door clips per panel.
 ☞ Professional insallation recommended.

1974 CHARGER SE & CHARGER STANDARD BENCH STYLE

This Legendary product features as-original Die-electrically heat sealed Oxford grain upper with woodgrain lower and chrome center accent. Special cutout area in filler board to accommodate armrest base. Padded Multi-Level Construction 3-Dimensional Panel.



Upper Front Panels (Vinyl) **DO74CX00012(C)**
 100, 200, 360, 450..... \$459/pr.
 264..... \$622/pr. (L4)
 680..... \$625/pr. (L1)

Upper Rear Panels (Vinyl)..... **DO74CX00048(C)**
 ☞ For Charger models only.
 100, 200, 360, 450..... \$263/pr.
 264..... \$371/pr. (L4)
 680..... \$372/pr. (L1)

Upper Rear Panels (Vinyl)..... **DO74CX00048(C)**
 ☞ For Charger SE models only. 100, 200, 360, 450 \$263/pr.
 264..... \$371/pr. (L4)
 680..... \$372/pr. (L1)
 ☞ Professional insallation recommended.

1973 CHARGER SE & CHARGER BUCKET & DELUXE BENCH STYLE

This Legendary product features as-original Die-electrically heat sealed Coachman grain upper for bench seat models or Cologne grain upper for bucket seat models with woodgrain lower and chrome center accent. Special cutout area in filler board to accommodate armrest base. Padded Multi-Level Construction 3-Dimensional Panel.

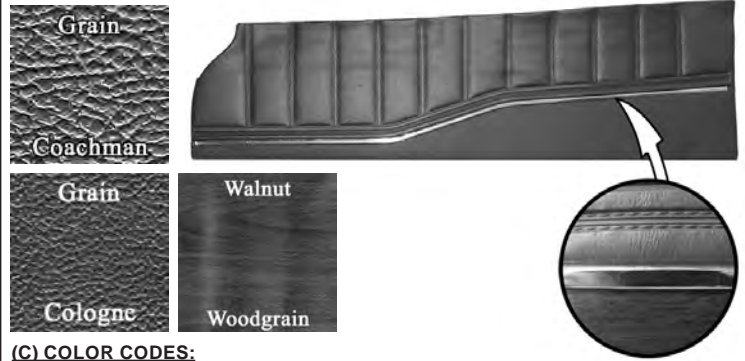

(C) COLOR CODES:

- (100) Black
- (200) White
- (250) Parchment
- (340) Bright Blue
- (444) Dark Green
- (671) Honey Gold (Requires Sample Approval)
- (672) Honey Gold

Upper Front Panels (Vinyl) (Bucket models) **DO73CX00012(C)**
 Upper Front Panels (Vinyl) (Bench models)..... **DO73CX00020(C)**
 100, 200, 250, 340, 444, 671..... \$459/pr.
 672..... \$625/pr. (L1)
 ☞ Not correct for Charger SE models with optional cloth bench interior trim

Upper Rear Panels (Vinyl) (Bucket models)..... **DO73CX00048(C)**
 Upper Rear Panels (Vinyl) (Bench models)..... **DO73CX00080(C)**
 ☞ For Charger models only
 100, 200, 250, 340, 444, 671..... \$263/pr.
 672..... \$372/pr. (L1)

Upper Rear Panels (Vinyl) (Bucket models)..... **DO73CX00048(C)**
 ☞ For Charger SE models only.
 ☞ This panel wasn't offered in 1973 Charger SE models w/ bucket seat interior trim but may be purchased as a special order.
 Upper Rear Panels (Vinyl) (Bench models)..... **DO73CX00080(C)**
 100, 200, 250, 340, 444, 671..... \$263/pr.
 672..... \$372/pr. (L1)
 ☞ Not correct for Charger SE models with optional cloth bench interior trim.

1965 CORONET BUCKET STYLE

This Legendary product features as-original Die-electrically heat sealed Bison grain with Record Groove grain insert, chrome accents and carpeted lower. Cutout area in filler board to accommodate armrest base. Padded Multi-Level Construction 3-Dimensional Panel.

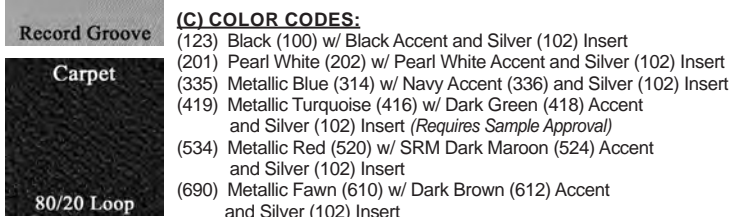
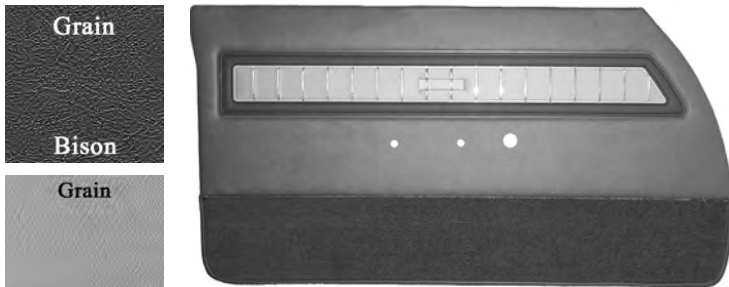

(C) COLOR CODES:

- (123) Black (100) w/ Black Accent and Silver (102) Insert
- (201) Pearl White (202) w/ Pearl White Accent and Silver (102) Insert
- (335) Metallic Blue (314) w/ Navy Accent (336) and Silver (102) Insert
- (419) Metallic Turquoise (416) w/ Dark Green (418) Accent and Silver (102) Insert *(Requires Sample Approval)*
- (534) Metallic Red (520) w/ SRM Dark Maroon (524) Accent and Silver (102) Insert
- (690) Metallic Fawn (610) w/ Dark Brown (612) Accent and Silver (102) Insert

Front Panels (Unassembled)..... **DO65CW00010(C)**
123, 201, 335, 419..... \$690/pr.

534..... \$803/pr. (L1)
690..... \$768/pr. (L2)

☞ Customer must reuse original metal trim.

Front Panels (Pre-assembled)..... **DO65CW00010(C)-PA** 

123, 201, 335, 419..... \$907/pr.
534..... \$1024/pr. (L1)
690..... \$1010/pr. (L2)

☞ Customer must reuse original metal trim.

☞ Includes original style upper metal rail & window felt strip.

Hardtop Rear Panels..... **DO65CW00040(C)**
123, 201, 335, 419..... \$306/pr.

534..... \$418/pr. (L1)
690..... \$374/pr. (L2)

☞ Customer must reuse original metal trim.

Convertible Rear Panels..... **DO65CW00050(C)**
123, 201, 335, 419..... \$264/pr.

534..... \$374/pr. (L1)
690..... \$331/pr. (L2)

☞ Customer must reuse original metal trim.

1966 CORONET 500 BUCKET STYLE

This Legendary product features as-original Die-electrically heat sealed Cologne grain with carpeted lower section. Special cutout area in filler board to accommodate armrest base. Padded Multi-Level Construction 3-Dimensional Panel.

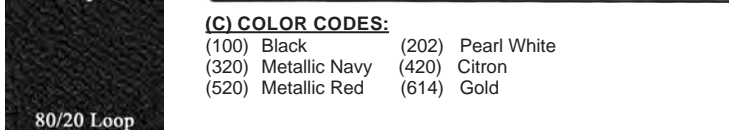

(C) COLOR CODES:

- (100) Black
- (202) Pearl White
- (320) Metallic Navy
- (420) Citron
- (520) Metallic Red
- (614) Gold

Front Panels..... **DO66CW00010(C)**
(All colors)..... \$459/pr.

☞ Please refer to carpet color selection page to specify carpet color at time of order.

☞ Customer must reuse original metal trim

☞ Require (13) door clips per panel.

Hardtop Rear Panels..... **DO66CW00040(C)**
(All colors)..... \$263/pr.

☞ Require (3) door clips per panel.

Convertible Rear Panels..... **DO66CW00050(C)**
(All colors)..... \$168/pr.

☞ Require (3) door clips per panel.

1965 CORONET 440 BENCH STYLE

This Legendary product features as-original Die-electrically heat sealed Bison grain with Ribbed grain center strip and chrome accents. Special cutout area in filler board to accommodate armrest base. Padded Multi-Level Construction 3-Dimensional Panel.

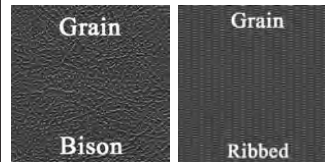

(C) COLOR CODES:

- (314) Metallic Blue
- (416) Metallic Turquoise
- (537) Dark Maroon (526) / Metallic Red (538)
- (610) Metallic Fawn

Front Panels (Unassembled)..... **DO65CW00020(C)**
(All colors)..... \$647/pr.

☞ Require (16) door clips per panel.

Front Panels (Pre-assembled)..... **DO65CW00020(C)-PA** 

(All colors)..... \$891/pr.

☞ Require (16) door clips per panel.

☞ Includes original style upper metal rail & window felt strip.

Hardtop Rear Panels..... **DO65CW00080(C)**
(All colors)..... \$288/pr.

☞ Require (6) door clips per panel.

Convertible Rear Panels..... **DO65CW00060(C)**
(All colors)..... \$244/pr.

☞ Require (6) door clips per panel.

☞ Professional installation recommended.

1966 CORONET 440 BENCH STYLE

This Legendary product features as-original Die-electrically heat sealed Bedford grain upper and Cologne grain lower with chrome accent. Special cutout area in filler board to accommodate armrest base. Padded Multi-Level Construction 3-Dimensional Panel.



(C) COLOR CODES:

- (100) Black
- (202) Pearl White
- (321) Light Blue (313) / Dark Blue (314)
- (520) Metallic Red
- (629) Light Gold (618) / Gold (614)

Front Panels..... **DO66CW00020(C)**
100, 202, 321, 520..... \$478/pr.

629..... \$777/pr. (L1)

☞ Require (13) door clips per panel.

Hardtop Rear Panels..... **DO66CW00080(C)**
100, 202, 321, 520..... \$273/pr.

629..... \$468/pr. (L1)

☞ Require (3) door clips per panel.

Convertible Rear Panels..... **DO66CW00060(C)**
100, 202, 321, 520..... \$168/pr.

☞ Require (3) door clips per panel.



1967 CORONET R/T & CORONET 500 BUCKET STYLE

This Legendary product features as-original Die-electrically heat sealed Cologne grain vinyl with carpeted lower section. Special cutout area in filler board to accommodate armrest base. Padded Multi-Level Construction 3-Dimensional Panel.

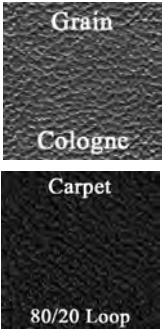

(C) FRONT COLOR CODES:

- (100) Black
- (202) Pearl White
- (320) Metallic Navy
- (520) Metallic Red
- (620) Copper
- (630) Gold

Front Panels **DO67CW00010(C)**
 (All colors)..... \$459/pr.
 ☞ Please refer to carpet color selection at time of order.
 ☞ Customer must reuse original metal trim.
 ☞ Require (13) door clips per panel.

Hardtop Rear Panels **DO67CW00040(C)**
 100, 203, 320, 520, 647..... \$263/pr.
 641..... \$350/pr. (L2)
 ☞ Please specify 2nd vinyl color on lower panel section.
 ☞ Require (3) door clips per panel.

Convertible Rear Panels **DO67CW00050(C)**
 100, 203, 320, 520, 647..... \$168/pr.
 641..... \$219/pr. (L1)
 ☞ Please specify 2nd vinyl color on lower panel section.
 ☞ Require (3) door clips per panel.

1968 CORONET 440 & SUPERBEE BENCH STYLE

This Legendary product features as-original Die-electrically heat sealed Cologne grain vinyl. Special cutout area in filler board to accommodate armrest base. Padded Multi-Level Construction 3-Dimensional Panel.

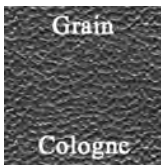

(C) COLOR CODES:

- (100) Black
- (202) Pearl White
- (332) Light Metallic Blue
- (432) Light Metallic Green
- (520) Metallic Red

Front Panels **DO68CW00020(C)**
 100, 202, 332, 432, 520..... \$439/pr.
 ☞ Require (13) door clips per panel.

Hardtop Rear Panels **DO68CW00080(C)**
 100, 202, 332, 432, 520..... \$252/pr.
 ☞ Require (3) door clips per panel.

1968 CORONET R/T & CORONET 500 BUCKET STYLE

This Legendary product features as-original Die-electrically heat sealed Cologne grain vinyl. Special cutout area in filler board to accommodate armrest base. Padded Multi-Level Construction 3-Dimensional Panel.

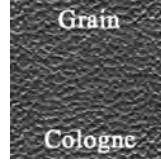
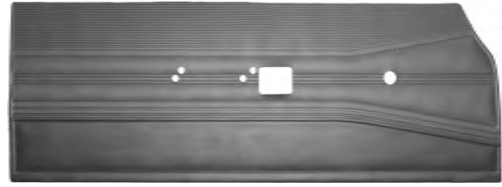

(C) COLOR CODES:

- (100) Black
- (202) Pearl White
- (337) Dark Metallic Blue (330) / Light Metallic Blue (332)
- (430) Dark Metallic Green
- (533) (520) Metallic Red / (526) Metallic Maroon
- (647) Gold (630) / Black (100)

Front Panels **DO68CW00010(C)**
 (All colors)..... \$439/pr.
 ☞ Require (13) door clips per panel.

Hardtop Rear Panels **DO68CW00040(C)**
 (All colors)..... \$252/pr.
 ☞ Require (3) door clips per panel.

Convertible Rear Panels **DO68CW00050(C)**
 (All colors)..... \$159/pr.
 ☞ Require (3) door clips per panel.

1968 CORONET DELUXE BENCH STYLE

This Legendary product features as-original Die-electrically heat sealed Cologne grain vinyl with Reed grain inserts. Special cutout area in filler board to accommodate armrest base. Padded Multi-Level Construction 3-Dimensional Panel.

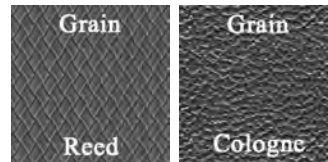

(C) COLOR CODES:

- (100) **Black
- (102) Silver
- (105) **Black (100) / Silver (102)
- (220) Oyster
- (330) Dark Metallic Blue

Front Panels **DO68CRWE020(C)**
 100, 102, 105, 330..... \$459/pr. (L1)
 220..... \$695/pr.
 ☞ Require (13) door clips per panel.

Hardtop Rear Panels **DO68CRWE080(C)**
 100, 102, 105, 330..... \$263/pr.
 220..... \$428/pr. (L1)
 ☞ Require (3) door clips per panel.

** (100) BLACK AND (105) BLACK/SILVER WERE NOT OFFERED IN 1968 CORONET DELUXE MODELS, BUT MAY BE PURCHASED AS A SPECIAL ORDER. AVAILABLE ONLY AS A PREPAID, NON-REFUNDABLE AND NON-RETURNABLE.

1969 CORONET R/T, 500 & SUPERBEE BUCKET & CONV. BENCH STYLE

This Legendary product features as-original Die-electrically heat sealed Coachman grain vinyl. Special cutout area in filler board to accommodate armrest base. Padded Multi-Level Construction 3-Dimensional Panel.

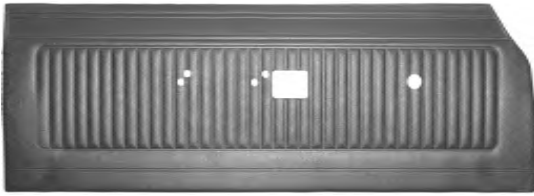

(C) COLOR CODES:
 (100) Black
 (200) White
 (330) Dark Metallic Blue
 (434) Dark Metallic Green
 (528) Red
 (650) Saddle

Front Panels **DO69CW00010(C)**
 (All colors).....\$439/pr.
 Ⓢ Require (13) door clips per panel.

Hardtop Rear Panels **DO69CW00040(C)**
 (All colors).....\$252/pr.
 Ⓢ Require (3) door clips per panel.

Convertible Rear Panels..... **DO69CW00050(C)**
 (All colors).....\$159/pr.
 Ⓢ Not for Superbee models.
 Ⓢ Require (3) door clips per panel.

1969 CORONET 440 & SUPERBEE BENCH STYLE

This Legendary product features as-original Die-electrically heat sealed Coachman grain with heatsealed Dodge emblem. Special cutout area in filler board to accommodate armrest base. Padded Multi-Level Construction 3-Dimensional Panel.

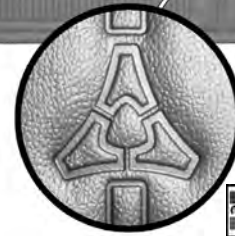
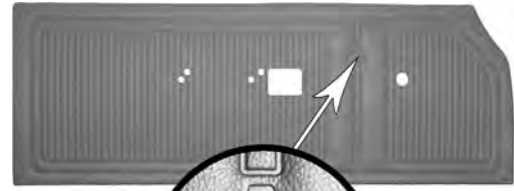

(C) COLOR CODES:
 (100) Black
 (200) White
 (332) Light Metallic Blue
 (432) Light Metallic Green
 (528) Red
 (650) Saddle

Front Panels **DO69CW00020(C)**
 (All colors).....\$478/pr.
 Ⓢ Require (13) door clips per panel.

Hardtop Rear Panels **DO69CW00080(C)**
 (All colors).....\$252/pr.
 Ⓢ Require (3) door clips per panel.

1969 CORONET DELUXE DELUXE & STANDARD BENCH STYLE

This Legendary product features as-original Die-electrically heat sealed Cologne grain vinyl with Reed grain inserts. Special cutout area in filler board to accommodate armrest base. Padded Multi-Level Construction 3-Dimensional Panel.



(C) COLOR CODES:
 (130) Pewter
 (332) Light Metallic Blue
 (650) Saddle

Front Panels **DO69CRE0020(C)**
 (All colors).....\$458/pr.
 Ⓢ Require (13) door clips per panel.

Hardtop Rear Panels **DO69CRE0080(C)**
 (All colors).....\$251/pr.
 Ⓢ Require (3) door clips per panel.

1970 CORONET R/T, 500 & SUPERBEE BUCKET & CONV. BENCH STYLE

This Legendary product features as-original Die-electrically heat sealed Coachman grain vinyl. Special cutout area in filler board to accommodate armrest base. Padded Multi-Level Construction 3-Dimensional Panel.

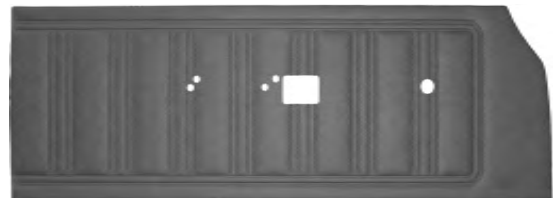

(C) COLOR CODES:
 (100) Black
 (200) White
 (330) Dark Metallic Blue
 (434) Dark Metallic Green
 (540) Burnt Orange
 (656) Brown
 (660) Gold

Front Panels **DO70CWS0012(C)**
 100, 200, 330, 434, 540, 656.....\$439/pr.
 660.....\$739/pr. (L1)
 Ⓢ Superbee models with buckets seats only.
 Ⓢ Require (13) door clips per panel.

Hardtop Rear Panels **DO70CWS0048(C)**
 100, 200, 330, 434, 540, 656.....\$252/pr.
 660.....\$449/pr. (L1)
 Ⓢ Superbee models with buckets seats only.
 Ⓢ Require (3) door clips per panel.

Convertible Rear Panels..... **DO70CWS0056(C)**
 100, 200, 330, 434, 540, 656.....\$159/pr.
 660.....\$302/pr. (L1)
 Ⓢ Not for Superbee models.
 Ⓢ Require (3) door clips per panel.



1970 CORONET 440 & SUPERBEE BENCH STYLE

This Legendary product features as-original Die-electrically heat sealed Coachman grain vinyl with chrome accent bands. Special cutout area in filler board to accommodate armrest base. Padded Multi-Level Construction 3-Dimensional Panel.



(C) COLOR CODES:

- (100) Black
- (200) White
- (330) Dark Metallic Blue
- (434) Dark Metallic Green
- (540) Burnt Orange
- (656) Brown

Front Panels **DO70CWD0012(C)**
 (All colors) \$459/pr.

☞ Require (13) door clips per panel.

Hardtop Rear Panels **DO70CWD0048(C)**
 (All colors) \$263/pr.

☞ Require (3) door clips per panel.

1964 SPORT FURY BUCKET STYLE

This Legendary product features as-original Die-electrically heat sealed Bison grain vinyl with chrome accents. Special cutout area in filler board to accommodate armrest base. Padded Multi-Level Construction 3-Dimensional Panel.

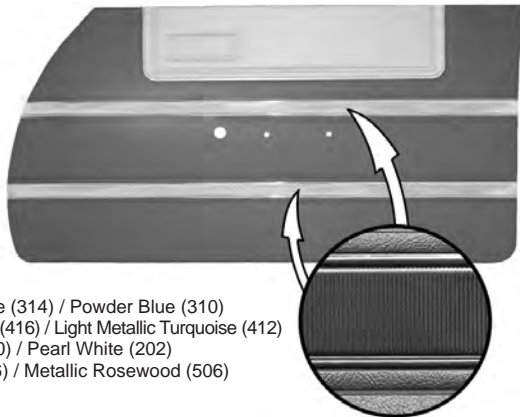
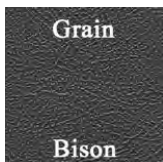

(C) COLOR CODES:

- (100) Black
- (319) Light Metallic Blue (314) / Powder Blue (310)
- (417) Metallic Turquoise (416) / Light Metallic Turquoise (412)
- (511) Crimson Red (510) / Pearl White (202)
- (609) Dark Copper (606) / Metallic Rosewood (506)

Front Panels (Unassembled) **DO64CF00010(C)**
 100, 511 \$670/pr.

319, 417, 609 \$814/pr. (L1)

☞ Require (16) door clips per panel.

Front Panels (Pre-assembled) **DO64CF00010(C)-PA** 

100, 511 \$891/pr.

319, 417, 609 \$1074/pr. (L1)

☞ Require (16) door clips per panel.

☞ Includes original style upper metal rail & window felt strip.

Hardtop Rear Panels **DO64CF00040(C)**
 100, 511 \$294/pr.

319, 417, 609 \$389/pr. (L1)

☞ Require (6) door clips per panel.

Convertible Rear Panels **DO64CF00050(C)**
 100, 511 \$252/pr.

319, 417, 609 \$331/pr. (L1)

☞ Require (6) door clips per panel.

1963 SPORT FURY BUCKET STYLE

This Legendary product features as-original Die-electrically heat sealed Pinpoint grain upper and Bison grain middle with carpet lower. Special cutout area in filler board to accommodate armrest base. Padded Multi-Level Construction 3-Dimensional Panel.

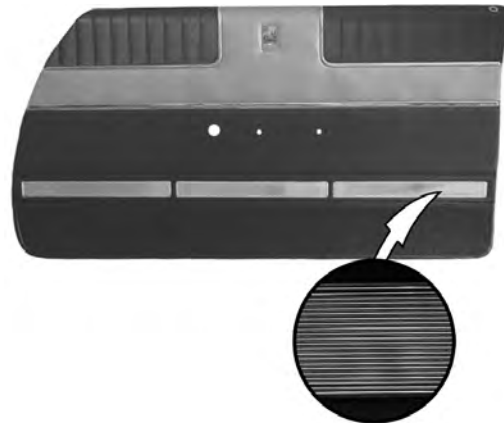
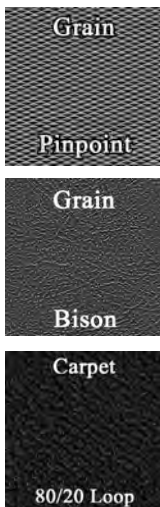

(C) COLOR CODES:

- (117) Black (100) w/ Copper (604) Accent
- (305) Blue (302) w/ Light Blue (304) Accent
- (513) Crimson Red (510) w/ Dark White (204) Accent

Front Panels (Unassembled) **DO63CF00010(C)**
 305, 513 \$690/pr.

117 \$846/pr. (L1)

☞ Please refer to carpet color selection at time of order.

☞ Customer must reuse original metal trim.

Front Panels (Pre-assembled) **DO63CF00010(C)-PA** 

305, 513 \$906/pr.

117 \$1056/pr. (L1)

☞ Please refer to carpet color selection at time of order.

☞ Customer must reuse original metal trim.

☞ Includes original style upper metal rail & window felt strip.

Hardtop Rear Panels **DO63CF00040(C)**
 305, 513 \$306/pr.

117 \$412/pr. (L1)

☞ Please refer to carpet color selection at time of order.

☞ Customer must reuse original metal trim.

Convertible Rear Panels (w/o rear armrest) **DO63CF00050(C)**
 Convertible Rear Panels (with rear armrest) **DO63CF00L50(C)**

305, 513 \$264/pr.

117 \$340/pr. (L1)

☞ Please refer to carpet color selection at time of order.

☞ Customer must reuse original metal trim.

1964 FURY BENCH STYLE

This Legendary product features as-original Die-electrically heat sealed Bison grain vinyl. Special cutout area in filler board to accommodate armrest base. Padded Multi-Level Construction 3-Dimensional Panel.



Grain

(C) COLOR CODES:

- (100) Black
- (312) Dark Blue (333) / Metallic Blue (314)
- (422) Dark Metallic Turquoise (414) / Metallic Turquoise (416)
- (512) Dark Red (504) / Crimson Red (510)
- (658) Dark Metallic Brown (608) / Metallic Fawn (610)
- (686) Chestnut (600) / Copper (606)

Bison

Front Panels (Unassembled).....	DO64CF00020(C)
100, 312, 422, 512, 686.....	\$670/pr.
658.....	\$891/pr.

☞ Customer must reuse original metal trim.

Front Panels (Pre-assembled).....	DO64CF00020(C)-PA 
100, 312, 422, 512, 686.....	\$891/pr.
658.....	\$1122/pr.

☞ Customer must reuse original metal trim.

☞ Includes original style upper metal rail & window felt strip.

Hardtop Rear Panels.....	DO64CF00080(C)
100, 312, 422, 512, 686.....	\$294/pr.
658.....	\$448/pr.

☞ Customer must reuse original metal trim.

Convertible Rear Panels.....	DO64CF00060(C)
100, 312, 422, 512, 686.....	\$252/pr.

☞ Customer must reuse original metal trim.

☞ Color code 658 was not available in a convertible model.

1965 SPORT FURY BUCKET STYLE

This Legendary product features as-original Die-electrically heat sealed Cologne grain upper and Bison grain middle with carpeted lower. Special cutout area in filler board to accommodate armrest base. Padded Multi-Level Construction 3-Dimensional Panel.

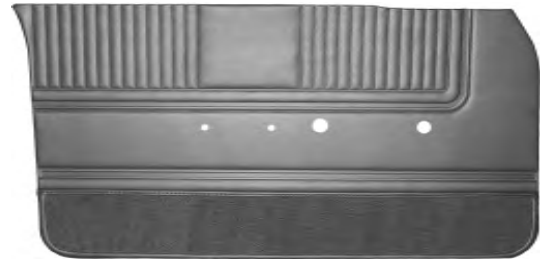

Grain

Grain

(C) COLOR CODES:

- (100) Black
- (119) Copper (602) / Black (100)
- (320) Metallic Navy
- (414) Dark Metallic Turquoise
- (520) Metallic Red
- (614) Gold

Cologne

Bison

Front Panels.....	DO65CF00010(C)
100, 320, 414, 520, 614.....	\$669/pr.
119.....	\$881/pr. (L1)

☞ Please refer to carpet color selection at time of order.

☞ Require (16) door clips per panel.

Hardtop Rear Panels.....	DO65CF00040(C)
100, 320, 414, 520, 614.....	\$294/pr.
119.....	\$448/pr. (L1)

☞ Please refer to carpet color selection at time of order.

☞ Require (6) door clips per panel.

Convertible Rear Panels.....	DO65CF00050(C)
100, 320, 414, 520, 614.....	\$252/pr.
119.....	\$354/pr. (L1)

☞ Please refer to carpet color selection at time of order.

☞ Require (6) door clips per panel.

☞ Professional installation recommended.

1964 POLARA 500 BUCKET STYLE

This Legendary product features as-original Die-electrically heat sealed Bison grain vinyl with carpeted lower section. Special cutout area in filler board to accommodate armrest base. Padded Multi-Level Construction 3-Dimensional Panel.

Front Panels (Unassembled).....	DO64CP00010(C)
100, 124, 511, 611.....	\$690/pr.
311, 417.....	\$898/pr. (L1)
413.....	\$973/pr. (L1)

☞ Please refer to carpet color selection at time of order.

☞ Customer must reuse original metal trim.

Front Panels (Pre-assembled).....	DO64CP00010(C)-PA 
100, 124, 511, 611.....	\$906/pr.
311, 417.....	\$1122/pr. (L1)
413.....	\$1163/pr. (L1)

☞ Please refer to carpet color selection at time of order.

☞ Customer must reuse original metal trim.

☞ Includes original style upper metal rail & window felt strip.

Hardtop Rear Panels.....	DO64CP00040(C)
100, 124, 511, 611.....	\$306/pr.
311, 417.....	\$449/pr. (L1)
413.....	\$495/pr. (L1)

☞ Please refer to carpet color selection at time of order.

☞ Customer must reuse original metal trim.

Convertible Rear Panels.....	DO64CP00050(C)
100, 124, 511, 611.....	\$264/pr.
311, 417.....	\$364/pr. (L1)
413.....	\$402/pr. (L1)

☞ Please refer to carpet color selection at time of order.

☞ Customer must reuse original metal trim.

Grain

Bison

Carpet

80/20 Loop

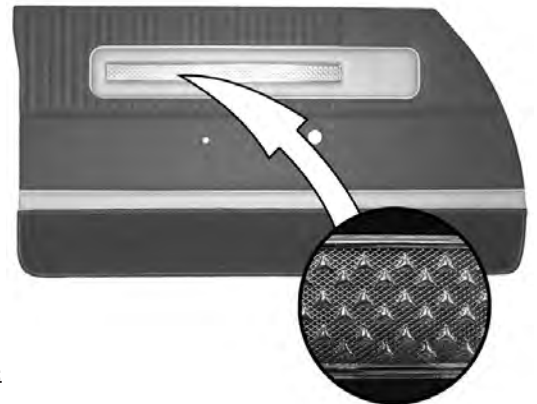

(C) COLOR CODES:

- (100) Black
- (124) Black (100) w/ Pearl White (202) Accent
- (311) Light Metallic Blue (314) w/ Powder Blue (310) Accent
- (413) Light Metallic Olive (410) w/ Pearl White (202) Accent
- (417) Met Turquoise (416) w/ Light Met Turquoise (412) Accent
- (511) Crimson Red (510) w/ Pearl White (202) Accent
- (611) Metallic Fawn (610) w/ Pearl White (202) Accent



1964-65 SUPERSTOCK

This Legendary product features as-original Die-electrically heat sealed Bison grain vinyl. Special cutout area in filler board to accommodate armrest base. Padded Multi-Level Construction 3-Dimensional Panel.

- Front Door Panels (Unassembled).....DO64CSS0010(C) \$688/pr.
- Front Door Panels (Pre-Assembled)DO64CSS0010(C)-PA  \$1029/pr.

*Window felt strip included.
Customer must provide original upper rail.*

- Rear Door Panels (Unassembled).....DO64CSS0040(C) \$289/pr.
- Rear Door Panels (Pre-Assembled)DO64CSS0040(C)-PA  \$542/pr.

*Window felt strip included.
Customer must provide original upper rail.*

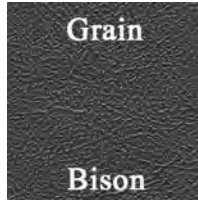

- (C) COLOR CODES:**
 (100) Black
 (510) Crimson Red
 (610) Metallic Fawn



1964-65 DODGE PLYMOUTH B BODY CONVERTIBLE REAR SIDE PANELS

Rear convertible side panels for 1964 65 B-Body models



- DO64CFPRW56100 (Black)..... \$359.00/pr.
- DO64CFPRW56510 (Red)..... \$359.00/pr.

ARMREST PADS

B & C-BODY MODELS



1964-66 B-Body reproduction front armrest pads feature the correct Bison grain finish.

AP64ABC01LR (Black)..... \$79.00/pr.
 ☞ These pads may also fit some C-Body models.



1966-67 B-Body, 1966-1967 Charger & 1966-70 C-Body reproduction 13" front armrest pads.

- AP66CRWX-FRT100 (Black)** \$109.00/pr.
 - AP66CRWX-FRT154 (Charcoal)**..... \$109.00/pr.
 - AP66CRWX-FRT200 (White)**..... \$109.00/pr.
 - AP66CRWX-FRT202 (Pearl White)** \$109.00/pr.
 - AP66CRWX-FRT318 (Light Met. Blue)**.. \$109.00/pr.
 - AP66CRWX-FRT320 (Met. Navy)** \$109.00/pr.
 - AP66CRWX-FRT330 (Dark Met. Blue)**.. \$109.00/pr.
 - AP66CRWX-FRT332 (Light Met. Blue)**.. \$109.00/pr.
 - AP66CRWX-FRT338 (Bright Blue)**..... \$109.00/pr.
 - AP66CRWX-FRT420 (Citron)**..... \$109.00/pr.
 - AP66CRWX-FRT430 (Dark Met. Green)**.. \$109.00/pr.
 - AP66CRWX-FRT434 (Dark Met. Green)**.. \$109.00/pr.
 - AP66CRWX-FRT520 (Met. Red)** \$109.00/pr.
 - AP66CRWX-FRT528 (Red)**..... \$109.00/pr.
 - AP66CRWX-FRT540 (Burnt Orange)**.. \$109.00/pr.
 - AP66CRWX-FRT614 (Gold)** \$109.00/pr.
 - AP66CRWX-FRT620 (Copper)**..... \$109.00/pr.
 - AP66CRWX-FRT630 (Gold)** \$109.00/pr.
 - AP66CRWX-FRT636 (Ember Gold)**.... \$109.00/pr.
 - AP66CRWX-FRT650 (Saddle)** \$109.00/pr.
 - AP66CRWX-FRT656 (Brown)** \$109.00/pr.
 - AP66CRWX-FRT670 ("Dukes" Tan)**.... \$109.00/pr.
- ☞ 13" armrest pads may also fit some C-Body models.
 ☞ Some 1966-67 B-Body models used 9 1/2" front armrest pads. If your armrests measure 9 1/2" please use 1968-70 armrest pad part number at time of order.



Reproduction 9 1/2" armrest pads for 1968-70 B-Body front armrests and 1966-70 B-Body rear armrests.

- AP68CRW100 (Black)**..... \$109.00/pr.
 - AP68CRW130 (Pewter)**..... \$109.00/pr.
 - AP68CRW154 (Charcoal)** \$109.00/pr.
 - AP68CRW200 (White)** \$109.00/pr.
 - AP68CRW202 (Pearl White)**..... \$109.00/pr.
 - AP68CRW220 (Oyster)** \$109.00/pr.
 - AP68CRW230 (Metallic Parchment)**..... \$109.00/pr.
 - AP68CRW318 (Light Metallic Blue)**..... \$109.00/pr.
 - AP68CRW320 (Metallic Navy)** \$109.00/pr.
 - AP68CRW330 (Dark Metallic Blue)**..... \$109.00/pr.
 - AP68CRW332 (Light Metallic Blue)**..... \$109.00/pr.
 - AP68CRW338 (Bright Blue)**..... \$109.00/pr.
 - AP68CRW416 (Metallic Turquoise)**..... \$109.00/pr.
 - AP68CRW420 (Citron)**..... \$109.00/pr.
 - AP68CRW430 (Dark Metallic Green)**..... \$109.00/pr.
 - AP68CRW432 (Light Metallic Green)**..... \$109.00/pr.
 - AP68CRW434 (Dark Metallic Green)**..... \$109.00/pr.
 - AP68CRW520 (Metallic Red)**..... \$109.00/pr.
 - AP68CRW526 (Metallic Maroon)**..... \$109.00/pr.
 - AP68CRW528 (Red)**..... \$109.00/pr.
 - AP68CRW540 (Burnt Orange)**..... \$109.00/pr.
 - AP68CRW614 (Gold)**..... \$109.00/pr.
 - AP68CRW618 (Light Gold)**..... \$109.00/pr.
 - AP68CRW620 (Copper)** \$109.00/pr.
 - AP68CRW630 (Gold)**..... \$109.00/pr.
 - AP68CRW634 (Light Metallic Fawn)**..... \$109.00/pr.
 - AP68CRW636 (Ember Gold)** \$109.00/pr.
 - AP68CRW650 (Saddle)**..... \$109.00/pr.
 - AP68CRW656 (Brown)**..... \$109.00/pr.
 - AP68CRW660 (Gold)**..... \$109.00/pr.
 - AP68CRW670 ("Dukes" Tan)** \$109.00/pr.
- ☞ 9 1/2" armrest pads may also fit some 1966-67 B-Body models.



Reproduction armrest pads for 1968-70 B-Body convertible rear armrests.

- AP68CRW-RRC100 (Black)**..... \$119.00/pr.
- AP68CRW-RRC200 (White)**..... \$119.00/pr.
- AP68CRW-RRC202 (Pearl White)**..... \$119.00/pr.

ARMREST BASES

B & C-BODY MODELS



1966-67 B-Body and 1966-70 Charger reproduction 16 1/4" front armrest bases. These bases feature the correct smooth chrome finish and accept 13" armrest pads.

AP66CRXBASECHR \$99.00/pr.
 ☞ 16 1/4" armrest bases may also fit some C-Body models.



1966-70 B-Body reproduction 10" rear armrest bases. These bases feature the correct smooth chrome finish and accept 9 1/2" armrest pads.

AP66CRWBASERR2..... \$69.00/pr.
 ☞ These bases will not fit convertible models.



1964-65 C-Body reproduction 15" armrest bases. Bases feature correct smooth chrome finish.

AP64ABC-BASE..... \$99.00/pr.



1968-70 B-Body reproduction 13" front armrest bases. These bases feature the correct smooth chrome finish and accept 9 1/2" armrest pads.

AP68CRWBASECHR \$89.00/pr.
 ☞ 13" armrest bases may also fit some 1966-67 B-Body models.
 ☞ These bases will not fit 1968-70 Charger models.



DOOR PANEL CLIPS



Door panel clips for all models except E-Body models.

DOCLIP \$1.00/ea.

DOOR LOCK KNOBS



Door lock knobs for all 1964-74 B-Body models. Available in black or chrome.

BT64ABC/DOOR-B (Black) \$15.00/pr.
BT64ABC/DOOR-C (Chrome) \$9.00/pr.
 ☞ Will not work for E-Body models.

DOOR LOCK FERRULES



BT68CRW-FERRULE

BT68CX-FERRULE

Authentically reproduced ferrules support the door lock knob.

1968-70 B-Body (except Charger)
BT68CRW-FERRULE \$29.00/pr.
 ☞ Stainless steel.

1968-70 Charger
BT68CX-FERRULE \$29.00/pr.
 ☞ Stainless steel.

ASH TRAYS

Reproduction ash trays and bezels for 1966-70 B-Body armrest pads, and 1971/74 B-Body consoles.

1966-70 B-Body (armrest pads only)
AT66BE \$59.00/ea.
 ☞ Metal tab on bezel must be trimmed for proper fit.

MAP POCKET EMBLEMS



1968-69 Charger door panel map pocket emblems. These square "button" trim pieces attach to the corners of the map pockets.

DO68CX-EMBLEM discontinued
 ☞ Use (2) per map pocket, (4) per car.

DOOR HANDLES B-BODY DOOR HANDLES



1963-66 C-Body 1963-65 B-Body door handles.
CK63ABC-DOOR \$39.00/pr.



1966-70 B-Body inside door handles.
CK66AB-DOOR \$59.00/pr.
 1971-74 B-Body inside door handles.
CK71B-DOOR \$59.00/pr.

WINDOW CRANK SPACERS



Front and rear window crank spacers for all 1968-74 B & C-Body models

1968-74 B & C-Body (all models)
CK68SPACER \$5.00/ea.
 ☞ Will work for front and rear windows on A, B & C-Body models.
 ☞ Will only work for front windows on E-Body models.

WINDOW CRANK SCREWS



Chrome plated window crank screws with hex like head for all 1968-74 B & C-Body models.

CK68SCREW \$2.00/ea.
 ☞ Use (4) per car.

VENT WINDOW CRANKS

1967 B & C-Body (all models)
CK67ABC-VENT \$29.00/ea.

WINDOW CRANKS



1963-66 B & C-Body window cranks

CK63ABC-WNDW \$29.00/ea.



1963-66 B & C-Body quarter glass window cranks

CK63ABC-QTR \$29.00/ea.



Reproduction front and rear window cranks for all 1967-74 B & C-Body models. Chrome plated with black knob.

1967 B & C-Body (all models)
CK67ABC-WNDW \$29.00/ea.
 ☞ Correct for front and rear windows.

1968-74 B & C-Body (all models)
CK68C-WNDW \$59.00/pr.
 ☞ Correct for front and rear windows.
 ☞ Screws and washers not included.

1968-74 B & C-Body (all models)
CK68C-WNDW1 \$69.00/pr.
 ☞ Correct for front and rear windows.
 ☞ Screws and thin washers included in this kit.



Providing the automotive industry
with the world's highest quality
soft trim products and services
RIGHT HERE AT HOME

STILL ASSEMBLED AND
MADE IN THE ★★★★★
USA 

THERE REALLY IS A DIFFERENCE!!



Legendary
AUTO INTERIORS LTD.®

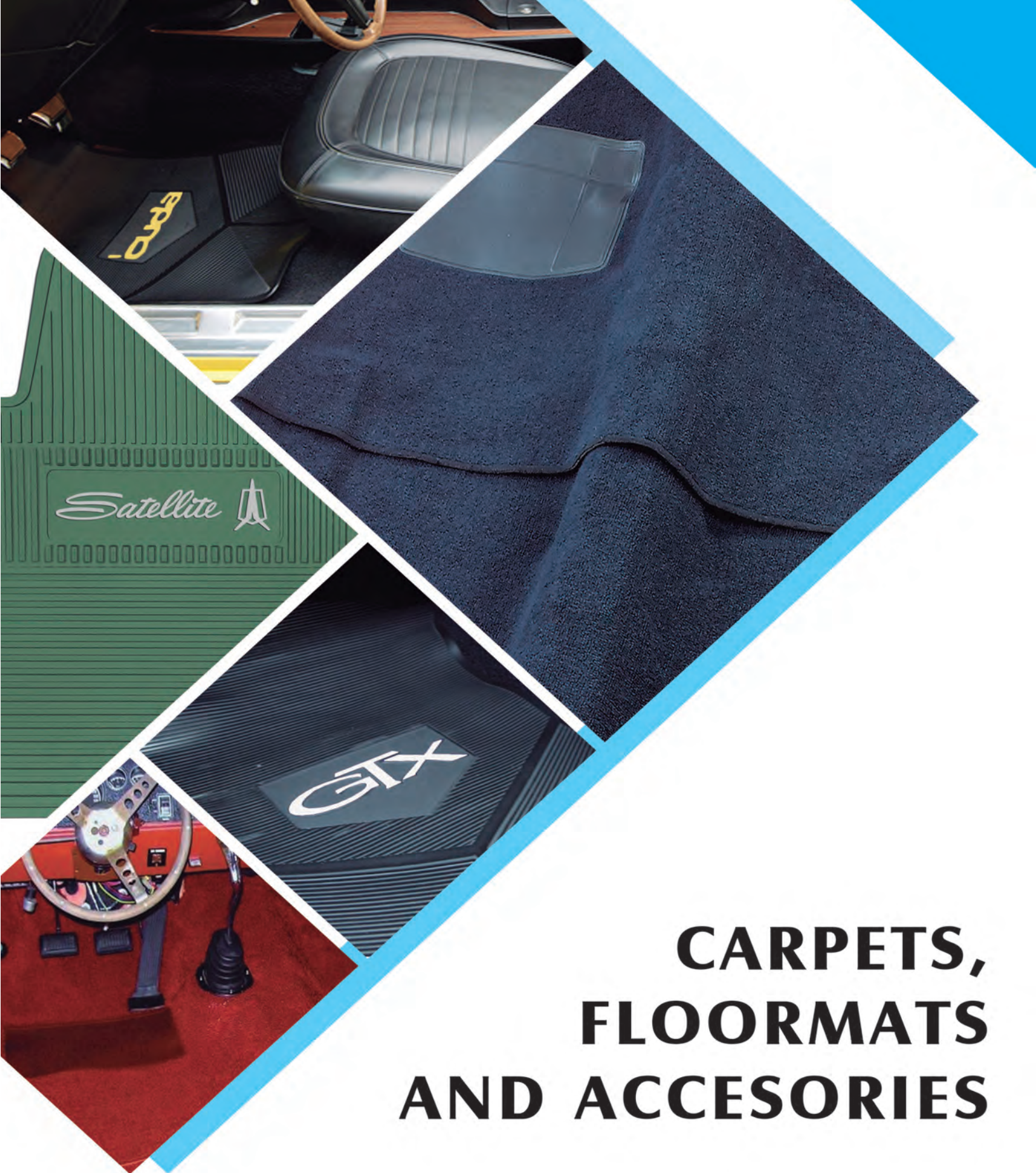

www.legendaryautointeriors.com





CARPETS, FLOORMATS AND ACCESORIES

 facebook.com/legendaryautointeriors
 twitter.com/legendaryautoin

 www.legendaryautointeriors.com
 instagram.com/legendaryautointeriorsltd
 youtube.com/user/legendaryauto



MODEL SPECIFIC CARPET

Legendary brand molded carpets utilize the heaviest face weight cutpile and loop carpet combined with an extra heavy poly coated backing that provides for an accurate and sharply detailed mold formed area. Surged edges and accurately die cut and applied 40oz. felt underlayment is the finishing touch to our vehicle specific carpets.

Bound and Surged Edges

Both Legendary cutpile and loop molded carpets have a heavy duty bound and surged edge that provides for an easy installation and clean appearance.



Underlayment Padding

Legendary molded carpets are made with a 40 oz. felt underlayment padding. All padding is trimmed around seat track mounts, seat belt holes and covers the most area than any carpet in the industry!

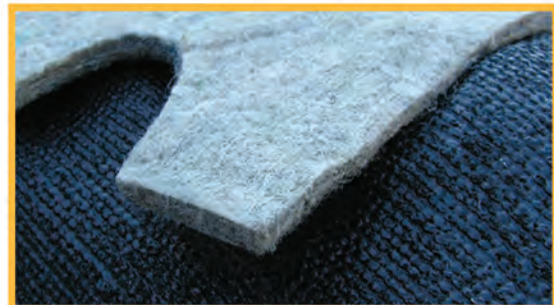

80/20 LOOP CARPET COLOR SELECTOR (c)

01 BLACK	03 RED	04 AQUA	05 DARK TEAL	06 FORD BLUE	07 DARK BLUE	08 TEAL	09 SHADE 13 BLUE
10 BRIGHT BLUE	11 MEDIUM BLUE	12 GREEN	13 DARK GREEN	14 DARK OLIVE GREEN	15 BLUE GREEN	16 MOSS GREEN	21 MEDIUM RED
22 BURNT ORANGE	24 ROSE BEIGE	25 DARK BROWN	26 SADDLE	27 LT/MEDIUM SADDLE	28 DARK COPPER	29 DARK SADDLE	31 MAROON
32 GOLD	33 DARK GOLD	34 FAWN	35 RED TUXEDO	36 BLUE TUXEDO	37 AQUA TUXEDO	38 LIGHT GREEN	39 ORANGE
40 PLUM	41 SUNSET GLOW	42 SILVER MINK	44 CORAL	45 EMBER GLOW	46 IVY GOLD	47 FAWN TUXEDO	48 SILVER
49 GUNMETAL GRAY	50 PARCHMENT	51 MIDNIGHT BLUE	53 GOLD TUXEDO	54 COPPER TUXEDO	55 OLIVE TUXEDO	81 CHARCOAL	

****36oz. JUTE PADDING INCLUDED WHERE PADDING WAS ORIGINAL.**

****VINYL BOUND EDGE WHERE THE FRONT AND REAR SECTIONS OF THE CARPET OVERLAP.**

****COLOR MATCHED ORIGINAL HEEL PAD ACCURATELY APPLIED USING THE SAME METHOD AS OEM.**

****MEETS OR EXCEEDS OEM SPECIFICATIONS.**

****DIMMER SWITCH GROMMET INCLUDED.**

****COLOR SAMPLES ARE AVAILABLE FOR COLORS OTHER THAN BLACK.**

****DYE LOTS WILL VARY +/- 10%. THIS IS COMMON IN THE CARPET INDUSTRY. CUSTOMERS ARE ENCOURAGED TO ORDER ALL CARPETED PRODUCTS AT THE SAME TIME TO ENSURE MATCHING DYE LOT.**

****FOR YEARS AND MODELS NOT LISTED PLEASE CALL OUR SALES DEPARTMENT AT 800-363-8804**

CUTPILE

CARPET COLOR SELECTOR (c)

801 BLACK	802 BLUE	807 DK. GRAY	808 TURQUOISE	810 BROWN	812 ROYAL BLUE	815 RED	818 OCEAN BLUE
819 DK. BLUE	820 SADDLE	821 TAUPE	825 MAROON	830 BUCKSKIN	835 FIRETHORNE	839 FED. BLUE	840 NAVY
849 JADE GREEN	850 CHAMOIS	852 SILVER	854 CARAMEL	857 MED. GRAY	869 WILLOW GREEN	871 SANDALWOOD	875 OXBLOOD
877 DOVE GRAY	885 LT. MAROON	897 CHARCOAL	1251 ALMOND	1804 SILVER	4033 MIDNIGHT BLUE	4305 OXBLOOD	4640 SADDLE
4643 POWDER BLUE	4666 SMOKE	4880 SAGE GREEN	7037 CAMEL TAN	7039 CARMINE	7075 OYSTER	7099 ANTELOPE	7130 DK. BLUE
7140 MED. SADDLE	7295 MEDIUM DOESKIN	7298 MAPLE	7500 BRIAR BROWN	7623 MEDIUM SAND GRAY	7701 GRAPHITE	7766 BLUE	8046 SILVER
8075 MED. GRAY	8082 LT. CRYSTAL BLUE	8384 DESERT TAN	8801 FLAME RED	8991 FORD SANDALWOOD	9006 LIGHT MOCHA	9196 MED. OPAL	9197 MEDIUM MOCHA
9199 SMOKE	9229 STEEL BLUE	9304 REGATTA BLUE	9577 MEDIUM DARK OAK	9777 BEIGE	9779 MED. GRAY	9779 TORCH RED	2000 CHROME YELLOW
2947-A RED	2005 HUGGER ORANGE	1998 ROYAL PURPLE	2003 LIMELIGHT GREEN	2004 ELECTRIC BLUE	8500 WHITE	1999 POWER PUMPKIN	2001 FUCHSIA

*For colors other than BLACK, a clean, non-faded sample may be helpful to assure a correct color match when ordering. Samples are available upon request. Dye lots will vary +/- 10%. This is common to industry standards and must be understood by the customer on all colors with or without sample approval. Customers are encouraged to order all carpeted products at one time to ensure the best dye lot matching. Carpeted items include: Seat back panels, Console carpet kits and certain model door panel carpet trim.

CARPET (NYLON LOOP)

The finest available today. Two-piece pre-molded shape made with an original specification blend of 100% Nylon. All carpets include 36oz. jute padding on the backside, dimmer switch grommet, color matched original style heel pad and vinyl bound edge where the front and rear sections overlap. Carpet kits are not shipped with pre-cut holes and must be done during installation of carpet. Some other minor trimming may be needed.

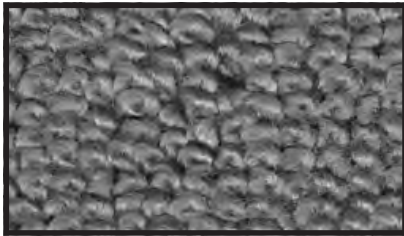

Loop Style

B-BODY MODELS

1962-65 B-Body

- CA62BA(C) (2-door/Automatic) \$195.00/ea.
- CA62BS(C) (2-door/Manual)..... \$195.00/ea.
- CA62B4DA(C) (4-door/Automatic)..... \$195.00/ea.

1962-65 B-Body "Tuxedo" style

- CA62BA(C) (2-door/Automatic) \$301.00/ea.
- CA62BS(C) (2-door/Manual)..... \$301.00/ea.

1966-67 Charger (See Diagram)

- CA66CXA(C)F (1966 Automatic)..... \$589.00/ea.
- CA66CXS(C)F (1966 Manual)..... \$589.00/ea.
- CA67CXA(C)F (1967 Automatic)..... \$589.00/ea.
- CA67CXS(C)F (1967 Manual)..... \$589.00/ea.

*Price depends on color

- CA66CXT(C) (66-67 Trunk Carpet Only)..... \$119.00/ea.

1966-70 B-Body

- CA66BA(C) (2-door/Automatic) \$195.00/ea.
 - CA66BS(C) (2-door/Manual)..... \$195.00/ea.
- Will not work for 1966-67 Charger models.

1971-74 B-Body

- CA71BA(C) (2-door/Automatic) \$195.00/ea.
- CA71BS(C) (2-door/Manual) w/bench \$195.00/ea.
- CA71BES(C) (2-door/Manual) w/bkt..... \$195.00/ea.

C-BODY MODELS

1963-71 C-Body

- CA63CA(C) (2-door/Automatic) \$275.00/ea.
- CA63CS(C) (2-door/Manual)..... \$275.00/ea.
- CA63C4DA(C) (4-door/Automatic)..... \$275.00/ea.

JUTE BACKING

This insulating material when placed between the floorpan and molded carpet enhances sound barrier protection from road noise and adds cushion to your carpet. Also helpful for insulating headliners, trunk areas and more. 36"x36" cut.

- TA200ZFELT (20 oz.)..... \$10.00/yd.
- TA400ZFELT (40 oz.)..... \$15.00/yd.

**1966-67 Charger Fastback
Carpet Diagram**

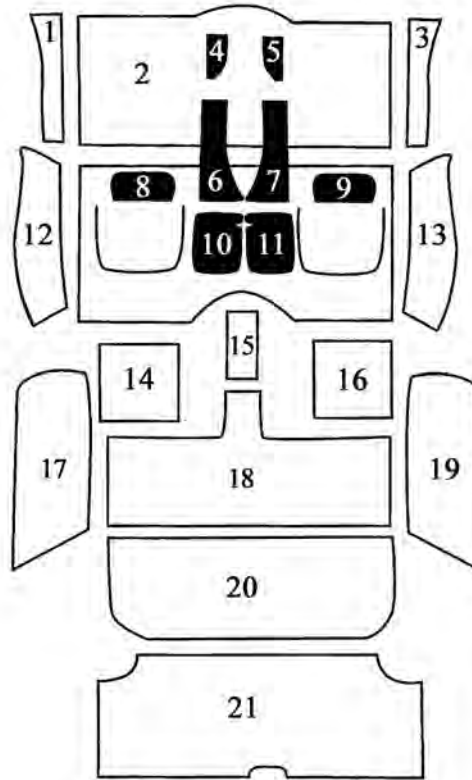

- 1 - Left Door Panel
- 2 - Floor-Pan (2 pc.)
- 3 - Right Door Panel
- 4 - Left Front Console
- 5 - Right Front Console
- 6 - Left Front Console
- 7 - Right Front Console
- 8 - Left Seatback
- 9 - Right Seatback
- 10 - Left Rear Console
- 11 - Right Rear Console
- 12 - Left Quarter Trim
- 13 - Right Quarter Trim
- 14 - Left Rear Seatback
- 15 - Fold-down Armrest
- 16 - Right Rear Seatback
- 17 - Left Wheel Well
- 18 - Cargo Floor
- 19 - Right Wheel Well
- 20 - Trunk Divider Door
- 21 - Trunk Mat
(sold seperately)

CARPET YARDAGE

Loop Carpet

- CAYD(C) (1 yard) \$79.00/yd.
- For colors other than black please refer to color code list

Loop "Tuxedo" Carpet

- CAYD(C) (1 yard) \$129.00/yd.
- For colors other than black please refer to color code list

Cut-pile Carpet

- CAYD(C)P (1 yard)..... \$79.00/yd.

CUT-PILE CARPET

Correct cut pile nylon carpet for 1972 and later cars and trucks. All carpets include 36oz. jute padding on the backside, dimmer switch grommet, color matched original style heel pad and vinyl bound edge where the front and rear sections overlap. Carpet kits not shipped with pre-cut holes and must be done during installation of carpet. Colors other than black require sample approval. Please call for samples.

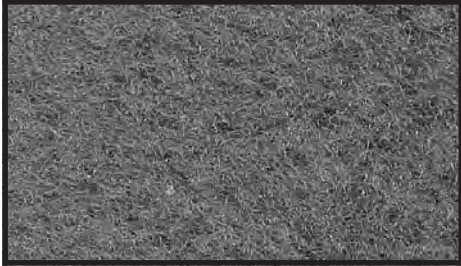

Cut-Pile Style

B-BODY MODELS

1971-74 B-Body

CA71BA(C)P (2-door/Automatic) \$195.00/ea.

CA71BS(C)P (2-door/Manual) \$195.00/ea.

☞ On 4-speed models please specify bench or bucket seats at time of order.

☞ On 4-speed models please specify B or E-Body style heel pad at time of order. (Some B-Body 4-speed models came with E-Body style heel pads)

C-BODY MODELS

1972-75 C-Body

CA70CA(C)P (2-door/Automatic) \$275.00/ea.

CA70CS(C)P (2-door/Manual) \$275.00/ea.

F-BODY MODELS

1976-80 F-Body

CA76CFA(C)P (Automatic) \$195.00/ea.

CA76CFS(C)P (Manual) \$195.00/ea.

DODGE TRUCK

1977-91

CA77D150A(C)P (Automatic) \$195.00/ea.

☞ Available for 2 wheel drive models only.

80/20 LOOP CARPET COLORS (C)

(01) Black	(32) Gold
(03) Red	(33) Dark Gold
(04) Aqua	(34) Fawn
(05) Teal	(36) Blue Tuxedo
(06) Ford Blue	(37) Aqua Tuxedo
(07) Dark Blue	(38) Light Green
(08) Teal	(39) Orange
(09) Shade 13 Blue	(40) Plum
(10) Bright Blue	(41) Sunset Glow
(11) Medium Blue	(42) Silver Mink
(12) Green	(44) Coral
(13) Dark Green	(45) Ember Glow
(14) Dark Olive Green	(46) Ivy Gold
(15) Blue Green	(47) Fawn Tuxedo
(16) Moss Green	(48) Silver
(21) Medium Red	(49) Gunmetal Grey
(22) Burnt Orange	(50) Parchment
(24) Rose Beige	(51) Midnight Blue
(25) Dark Brown	(53) Gold Tuxedo
(26) Saddle	(54) Copper Tuxedo
(27) Lt/Med Saddle	(55) Olive Tuxedo
(28) Dark Copper	(81) Charcoal
(29) Dark Saddle	
(31) Maroon	

*For colors other than BLACK, a clean, non-faded sample may be helpful to assure a correct color match when ordering. Samples are available upon request. Dye lots will vary +/- 10%. This is common to industry standards and must be understood by the customer on all colors with or without sample approval. Customers are encouraged to order all carpeted products at one time to ensure the best dye lot matching.





Providing the automotive industry
with the world's highest quality
soft trim products and services
RIGHT HERE AT HOME

STILL ASSEMBLED AND
MADE IN THE ★★★★★
USA 

THERE REALLY IS A DIFFERENCE!!

Legendary
AUTO INTERIORS LTD.®

www.legendaryautointeriors.com





LEGENDARY'S CUSTOM VINTAGE RUBBER STYLE FLOORMATS

DESIGNED TO FIT WHOLE FLOORPAN OF CAR LOGOS ON FRONT AND REAR MATS

How many times have you wished for automotive floormats that have custom-fit floopan shapes, that are easily cleanable and also have that "factory original" styling that would make you proud to display them in your classic car? Our "Custom Vintage" rubber style floormats will please the most discriminating buyer and provide years of carefree use.



www.legendaryautointeriors.com

CUSTOM DESIGN FLOORMATS

AVAILABLE IN ALL YEARS,
MAKES AND MODELS



Challenger
R/T

**1 Color
insert**

Adds \$25 to base price



Challenger
R/T

**2 Color
insert**

Adds \$50 to base price



Challenger
R/T

**3 Color
insert**

Adds \$75 to base price

**DESIGN YOUR OWN
INSERTS & COLORS**

www.legendaryautointeriors.com



FLOORMAT BASE & INSERT COLORS

BASE COLORS

001 Black - 007 Dark Blue - 011 Medium Blue - 018 Bright Red - 020 Red - 023 Tan - 031 Maroon
 033 Dark Gold - 037 Aqua - 050 Turquoise - 057 Dk Olive Green - 079 Gray
 098 Brown - 129 Dark Saddle - 132 Gold - 148 Silver Grey

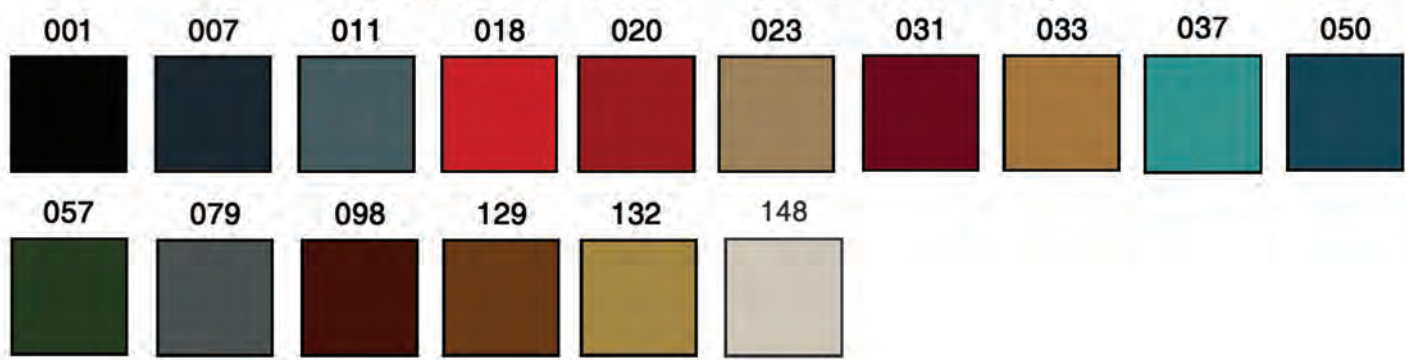

INSERT COLORS

133 Cream - 134 Sandalwood - 137 Aztec Gold - 138 Buckskin - 139 Sienna - 141 Coffee Bean - 142 Football - 143 Basketball
 150 Lemon Twist - 151 Mellow Yellow - 153 Precious Purple - 154 Plum Crazy - 155 Moody Blue - 156 Sky Blue
 157 Light Blue - 159 Pacific Blue - 160 Caribbean Blue - 161 Royal Blue - 163 Navy Blue - 164 Groovy Blue
 165 Sassy Grass - 166 Pine - 167 Mint Green - 168 Hunter Green - 169 Antique Green - 170 Aqua Marine - 171 Mango
 172 Awesome Orange - 173 Sunset Orange - 174 Panther Pink - 175 Radical Red - 176 Cherry Red - 177 Cranberry
 178 Razzberry - 179 Garnet - 180 Smoke - 181 Platinum - 182 Medium Grey - 183 Silver - 184 Charcoal



***Note - To order mats with colored inserts please call our sales department**

Actual colors will vary from samples on this page. Contact our Sample Request Department for actual color samples at 1-800-363-8804 or send us an email through our Sample Request Center on our website at www.legendaryautointeriors.com



1966-74 PLYMOUTH GTX, ROADRUNNER, SPORT SATELLITE, SATELLITE & BELVEDERE



1968-70 Roadrunner - Block letters w/ Plymouth emblem
FMCR0001001(C) - Automatic FMCR0001002(C) - 4-speed

1971-74 Roadrunner - Block letters w/ Plymouth emblem
FMCR0005001(C) - Automatic FMCR0005002(C) - 4-speed

1967-70 GTX - Block letters
FMCR0002001(C) - Automatic FMCR0002002(C) - 4-speed

1971-74 GTX - Block letters
FMCR0006001(C) - Automatic FMCR0006002(C) - 4-speed

1966-67 Belvedere I - Block letters w/ Plymouth emblem
FMCR0007001(C) - Automatic FMCR0007002(C) - 4-speed

1966-67 Belvedere II - Block letters w/ Plymouth emblem
FMCR0008001(C) - Automatic FMCR0008002(C) - 4-speed

1966 Satellite - Script letters w/ Plymouth emblem
FMCR0009001(C) - Automatic FMCR0009002(C) - 4-speed

1967-68 Satellite - Script letters w/ Plymouth emblem
FMCR0003001(C) - Automatic FMCR0003002(C) - 4-speed

1969-70 Satellite - Block letters w/ Plymouth emblem
FMCR0010001(C) - Automatic FMCR0010002(C) - 4-speed

1971-74 Satellite - Script letters w/ Plymouth emblem
FMCR0012001(C) - Automatic FMCR0012002(C) - 4-speed

1971-74 Satellite Sebring - Script letters w/ Plymouth emblem
FMCR0013001(C) - Automatic FMCR0013002(C) - 4-speed

1971-72 Satellite Sebring Plus - Script letters w/ Plymouth emblem
FMCR0014001(C) - Automatic FMCR0014002(C) - 4-speed

1973-74 Satellite Sebring Plus - Script letters w/ Plymouth emblem
FMCR0015001(C) - Automatic FMCR0015002(C) - 4-speed

1968 Sport Satellite - Script letters w/ Plymouth emblem
FMCR0011001(C) - Automatic FMCR0011002(C) - 4-speed

1969-70 Sport Satellite - Block letters w/ Plymouth emblem
FMCR0004001(C) - Automatic FMCR0004002(C) - 4-speed

1966-67 426 HEMI - Block letters
FMCDP001001(C) - Automatic FMCDP001002(C) - 4-speed

1968-70 HEMI - Block letters
FMCDP002001(C) - Automatic FMCDP002002(C) - 4-speed

1966-70 Pentastar
FMCDP003001(C) - Automatic FMCDP003002(C) - 4-speed

1971-74 Pentastar
FMCDP004001(C) - Automatic FMCDP004002(C) - 4-speed

**FLOORMAT PRICING:
ALL COLORS - \$189.00/set**



1966-74 DODGE CORONET & SUPERBEE



1966 Coronet - Script letters w/ Dodge emblem
FMCW0001001(C) - Automatic FMCW0001002(C) - 4-speed

1966 Coronet 440 - Script letters w/ Dodge emblem
FMCW0003001(C) - Automatic FMCW0003002(C) - 4-speed

1966 Coronet 500 - Script letters w/ Dodge emblem
FMCW0004001(C) - Automatic FMCW0004002(C) - 4-speed

1967-68 Coronet - Block letters w/ Dodge emblem
FMCW0005001(C) - Automatic FMCW0005002(C) - 4-speed

1967-68 Coronet 440 - Block letters w/ Dodge emblem
FMCW0006001(C) - Automatic FMCW0006002(C) - 4-speed

1967-68 Coronet 500 - Block letters w/ Dodge emblem
FMCW0007001(C) - Automatic FMCW0007002(C) - 4-speed

1967-68 Coronet R/T - Block letters w/ R/T
FMCW0002001(C) - Automatic FMCW0002002(C) - 4-speed

1969-70 Coronet - Block letters w/ Dodge emblem
FMCW0008001(C) - Automatic FMCW0008002(C) - 4-speed

1969-70 Coronet 440 - Block letters w/ Dodge emblem
FMCW0009001(C) - Automatic FMCW0009002(C) - 4-speed

1969-70 Coronet 500 - Block letters w/ Dodge emblem
FMCW0010001(C) - Automatic FMCW0010002(C) - 4-speed

1969-70 Coronet R/T - Block letters w/ R/T
FMCW0011001(C) - Automatic FMCW0011002(C) - 4-speed

1968-70 Super Bee - Block letters w/ logo
FMSB0001001(C) - Automatic FMSB0001002(C) - 4-speed

1971 Super Bee - Block letters w/ logo
FMSB0003001(C) - Automatic FMSB0003002(C) - 4-speed

1968-70 Super Bee - Bee logo only
FMSB0002001(C) - Automatic FMSB0002002(C) - 4-speed

1971 Super Bee - Bee logo only
FMSB0004001(C) - Automatic FMSB0004002(C) - 4-speed

1966-67 426 HEMI - Block letters
FMCDP001001(C) - Automatic FMCDP001002(C) - 4-speed

1968-70 HEMI - Block letters
FMCDP002001(C) - Automatic FMCDP002002(C) - 4-speed

1966-70 Pentastar
FMCDP003001(C) - Automatic FMCDP003002(C) - 4-speed

1971-74 Pentastar
FMCDP004001(C) - Automatic FMCDP004002(C) - 4-speed

FLOORMAT PRICING:
ALL COLORS - \$189.00/set

1966 Coronet



1966 Coronet 440



1966 Coronet 500



1967-68 Coronet



1967-68 Coronet 440



1967-68 Coronet 500



1967-68 Coronet R/T



1969-70 Coronet



1969-70 Coronet 440



1969-70 Coronet 500



1969-70 Coronet R/T



1968-71 Super Bee



1968-71 Bee

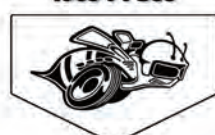

1966-67 426 HEMI



1968-70 HEMI



1966-74 Pentastar



1966-74 DODGE CHARGER



1966-70 Charger - Script letters w/ Dodge emblem
FMCX0001001(C) - Automatic FMCX0001002(C) - 4-speed

1968-70 Charger R/T - Script letters w/ R/T
FMCX0002001(C) - Automatic FMCX0002002(C) - 4-speed

1969 Charger Daytona - Block letters
FMCX0005001(C) - Automatic FMCX0005002(C) - 4-speed

1969-70 Charger 500 - Script letters
FMCX0006001(C) - Automatic FMCX0006002(C) - 4-speed

1969-70 Charger SE - Script letters w/ SE emblem
FMCX0007001(C) - Automatic FMCX0007002(C) - 4-speed

1971 Charger 500 - Script letters
FMCX0010001(C) - Automatic FMCX0010002(C) - 4-speed

1971-72 Charger SE - Script letters w/ SE emblem
FMCX0008001(C) - Automatic FMCX0008002(C) - 4-speed

1973-74 Charger SE - Script letters w/ SE emblem
FMCDP0009001(C) - Automatic FMCDP0009002(C) - 4-speed

1971-74 Charger - Script letters w/ Dodge emblem
FMCDP0003001(C) - Automatic FMCDP0003002(C) - 4-speed

1971 Charger R/T - Script letters w/ R/T
FMCDP0004001(C) - Automatic FMCDP0004002(C) - 4-speed

1966-67 426 HEMI - Block letters
FMCDP001001(C) - Automatic FMCDP001002(C) - 4-speed

1968-70 HEMI - Block letters
FMCDP002001(C) - Automatic FMCDP002002(C) - 4-speed

1966-70 Pentastar
FMCDP003001(C) - Automatic FMCDP003002(C) - 4-speed

1971-74 Pentastar
FMCDP004001(C) - Automatic FMCDP004002(C) - 4-speed

FLOORMAT PRICING:
ALL COLORS - \$189.00/set

1966-74 Charger



1968-71 Charger R/T



1969 Daytona



1969-71 Charger 500



1969-70 Charger SE



1971-72 Charger SE



1973-74 Charger SE



1966-67 426 HEMI



1968-70 HEMI



1966-74 Pentastar



ORIGINAL STYLE CHRYSLER & AMC



1970-76 A-Body & 1976-80 F-Body
FMOR70CLV000(C)

FLOORMAT PRICING:
ALL COLORS - \$149.00/set



1968-70 AMX/Javelin
FMOR68AAJ(C)

FLOORMAT PRICING:
ALL COLORS - \$289.00/set



NEXT GENERATION CUSTOM VINTAGE FLOORMATS

by **FLEXTREAD**[®]



ORDER TODAY!!

1962-66 CHRYSLER A & B-BODY MODELS

**AUTOMATIC
4-SPEED**

**HEAVYWEIGHT MATERIAL WITH AN AGGRESSIVE
DEEP TREAD DESIGN NOT ONLY LOOKS AMAZING
BUT ALSO HAS SUPERIOR FUNCTIONALITY!!**

**1-800-363-8804
WWW.LEGENDARYAUTOINTERIORS.COM
WWW.FLEXTREADMATS.COM**



NEXT GENERATION FLOORMATS

B-BODY MODELS

1962 Dart 330	
FMCLV018001 (Automatic).....	Black \$199.00/ea.
FMCLV018002 (Manual).....	\$199.00/ea.
1962 Dart 440	
FMCLV019001 (Automatic).....	\$199.00/ea.
FMCLV019002 (Manual).....	\$199.00/ea.
1962 Dart	
FMCLV020001 (Automatic).....	\$199.00/ea.
FMCLV020002 (Manual).....	\$199.00/ea.
1962 Polara 500	
FMCP0001001 (Automatic).....	\$199.00/ea.
FMCP0001002 (Manual).....	\$199.00/ea.
1963 Polara 500	
FMCP0002001 (Automatic).....	\$199.00/ea.
FMCP0002002 (Manual).....	\$199.00/ea.
1963 Polara	
FMCP0003001 (Automatic).....	\$199.00/ea.
FMCP0003002 (Manual).....	\$199.00/ea.
1963-64 Dodge 330	
FMCP0004001 (Automatic).....	\$199.00/ea.
FMCP0004002 (Manual).....	\$199.00/ea.
1963-64 Dodge 440	
FMCP0005001 (Automatic).....	\$199.00/ea.
FMCP0005002 (Manual).....	\$199.00/ea.

B-BODY MODELS CONT.

1964 Polara 500	
FMCP0006001 (Automatic).....	\$199.00/ea.
FMCP0006002 (Manual).....	\$199.00/ea.
1964 Polara	
FMCP0007001 (Automatic).....	\$199.00/ea.
FMCP0007002 (Manual).....	\$199.00/ea.
1965 Coronet	
FMCW0012001 (Automatic).....	\$199.00/ea.
FMCW0012002 (Manual).....	\$199.00/ea.
1965 Coronet 440	
FMCW0013001 (Automatic).....	\$199.00/ea.
FMCW0013002 (Manual).....	\$199.00/ea.
1965 Coronet 500	
FMCW0014001 (Automatic).....	\$199.00/ea.
FMCW0014002 (Manual).....	\$199.00/ea.
1962 Fury	
FMCF0001001 (Automatic).....	\$199.00/ea.
FMCF0001002 (Manual).....	\$199.00/ea.
1962-64 Sport Fury	
FMCF0002001 (Automatic).....	\$199.00/ea.
FMCF0002002 (Manual).....	\$199.00/ea.
1963-64 Fury	
FMCF0003001 (Automatic).....	\$199.00/ea.
FMCF0003002 (Manual).....	\$199.00/ea.

B-BODY MODELS CONT.

1962 Belvedere	
FMCRO016001 (Automatic).....	\$199.00/ea.
FMCRO016002 (Manual).....	\$199.00/ea.
1962 Savoy	
FMCRO017001 (Automatic).....	\$199.00/ea.
FMCRO017002 (Manual).....	\$199.00/ea.
1963-64 Belvedere	
FMCRO018001 (Automatic).....	\$199.00/ea.
FMCRO018002 (Manual).....	\$199.00/ea.
1963-64 Savoy	
FMCRO019001 (Automatic).....	\$199.00/ea.
FMCRO019002 (Manual).....	\$199.00/ea.
1965 Belvedere I	
FMCRO020001 (Automatic).....	\$199.00/ea.
FMCRO020002 (Manual).....	\$199.00/ea.
1965 Belvedere II	
FMCRO021001 (Automatic).....	\$199.00/ea.
FMCRO021002 (Manual).....	\$199.00/ea.
1965 Satellite	
FMCRO022001 (Automatic).....	\$199.00/ea.
FMCRO022002 (Manual).....	\$199.00/ea.

1962 Dart 330



1962 Dart 440



1962 Dart



1962 Polara 500



1963 Polara 500



1963 Polara



1963-64 Dodge 330



1963-64 Dodge 440



1964 Polara 500



1964 Polara



1965 Coronet



1965 Coronet 440



1965 Coronet 500



1962 Fury



1962-64 Sport Fury



1963-64 Fury



1962 Belvedere



1962 Savoy

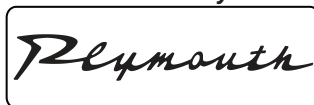

1963-64 Belvedere



1963-64 Savoy



1965 Belvedere I



1965 Belvedere II



1965 Satellite



FLEX TREAD®

YOU ASK FOR IT...WE DELIVERED!!

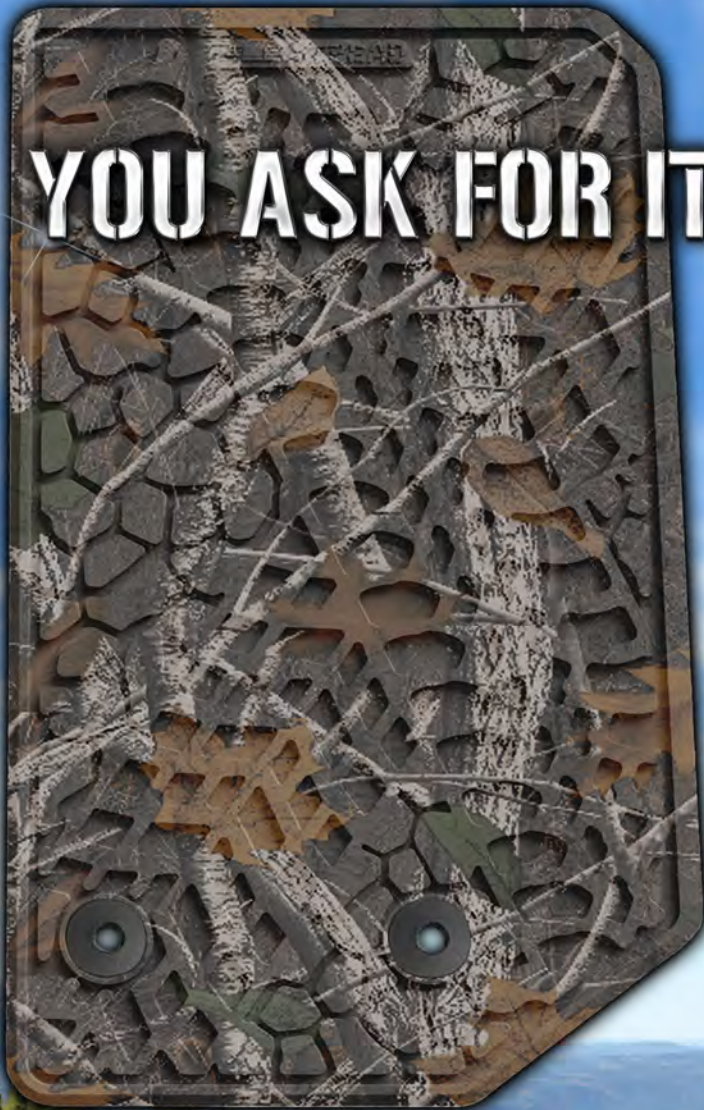

PINK COMING
2023!



YOU ASK FOR IT...WE DELIVERED!!

PATENTED

SCENERY MATS

VERSAFIT™ TRIM-TO-FIT MATS

**MANY KOOL SCENES AVAILABLE
AND MORE COMING SOON!**

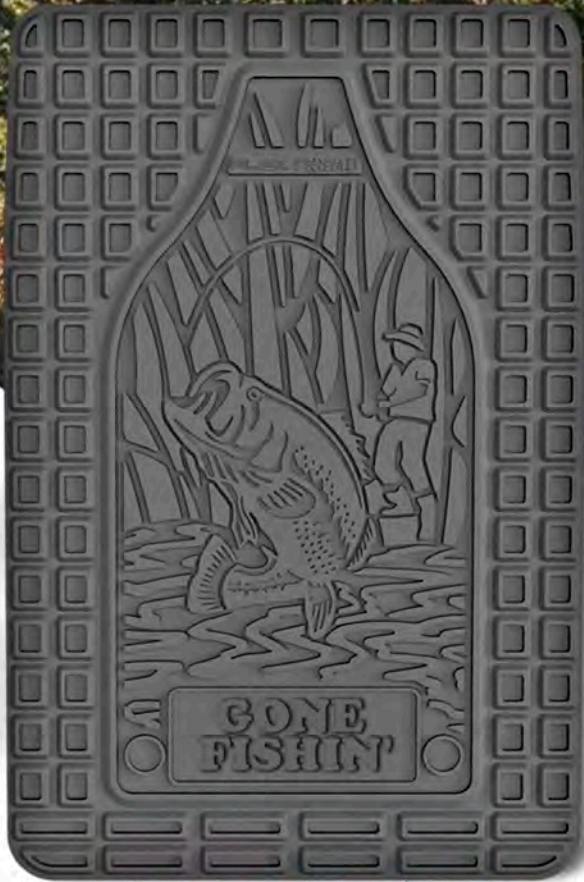

FISHING SCENE



BOOTMATS

DUCK SCENE

SCENERY AVAILABLE ON VERSAFIT™ & BOOTMATS



WHITETAIL SCENE



EQUINE SCENE



**SCORCHED EARTH &
TIRE TRACK SCENE**

Versafit™

Trim-To-Fit Mats

CHOOSE
YOUR
SCENE

VERSAFIT™ universal trim-to-fit floor mats fit most domestic and foreign vehicles. Mats can be cut to fit your vehicle's unique floorpan. Includes manual screw in style safety retention positioning posts for installation.



Bootmats

CHOOSE
YOUR
SCENE

"Fun"ctional Boot Mats from FLEXTREAD bring a KOOL look inside while leaving the mess at the door. Featuring scenery and measuring finished size 16" tall by 28" wide.



FLOORMAT & BOOTMAT COLORS



001 - Black

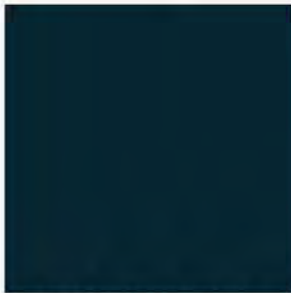

007 - Dark Blue



011 - Medium Blue



018 - Bright Red



020 - Red



023 - Tan



031 - Maroon



050 - Turquoise



057 - Dark Olive Green



074 - Pink



079 - Grey



098 - Brown



129 - Dark Saddle



132 - Gold

CAMOUFLAGE

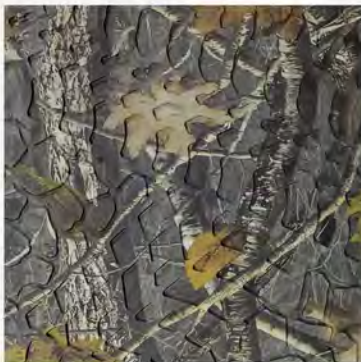

200 - Rugged Woods



202 - Cyberflage



201 - Rugged Woods "Pink"



203 - Cyberflage "Pink"

FLEXTREAD LLC
1-833-700-3539 EXT. 222
WWW.FLEXTREADMATS.COM



KICK PANELS

Reproduction plastic kick panels for 1966-74 B-Body models. Available in black or colors in deluxe "OEM" and standard.



1966-70 B-Body (all models)

KI66CRWX100 (Black).....	\$195.00/pr.
KI66CRWX200 (White).....	\$195.00/pr.
KI66CRWX320 (Metallic Navy).....	\$195.00/pr.
KI66CRWX330 (Dark Metallic Blue).....	\$195.00/pr.
KI66CRWX332 (Light Metallic Blue).....	\$195.00/pr.
KI66CRWX338 (Bright Blue).....	\$195.00/pr.
KI66CRWX416 (Metallic Turquoise).....	\$195.00/pr.
KI66CRWX430 (Dark Metallic Green).....	\$195.00/pr.
KI66CRWX434 (Dark Metallic Green).....	\$195.00/pr.
KI66CRWX520 (Metallic Red).....	\$195.00/pr.
KI66CRWX526 (Metallic Maroon).....	\$195.00/pr.
KI66CRWX528 (Red).....	\$195.00/pr.
KI66CRWX540 (Burnt Orange).....	\$195.00/pr.
KI66CRWX614 (Gold).....	\$195.00/pr.
KI66CRWX620 (Copper).....	\$195.00/pr.
KI66CRWX636 (Ember Gold).....	\$195.00/pr.
KI66CRWX638 (Dark Gold).....	\$195.00/pr.
KI66CRWX650 (Saddle).....	\$195.00/pr.
KI66CRWX656 (Brown).....	\$195.00/pr.

KICK PANEL INSULATION

Die-cut from the correct yellow insulation to properly fit behind the kick panels and reduce road noise.

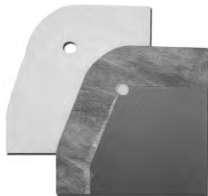

1963-64 Fury & Sport Fury

KI63CF \$39.00/kit

1963-65 Belvedere & Satellite

KI63CR \$29.00/kit

1966-70 B-Body (all models)

KI66CRWX \$19.00/kit

1971-74 B-Body (all models)

KI71CRX \$39.00/kit

FIREWALL INSULATION



Die-cut from black fiberboard with yellow insulation attached to properly fit the firewall. Clips included.

1963-64 Fury & Sport Fury ^{OS1}

FI63CFW/O (no air)..... \$49.00/kit
 FI62CR-HTR (heater delete section)..... \$29.00/kit
 ⚠ FI62CR-HTR is the heater delete area only. For the complete firewall pad, FI63CRW/O must be ordered with it.

1963-65 Belvedere & Satellite

FI63CRW/O (no air)..... \$49.00/kit
 FI62CR-HTR (heater delete section)..... \$14.00/kit
 ⚠ FI62CR-HTR is the heater delete area only. For the complete firewall pad, FI63CRW/O must be ordered with it.

1966-67 B-Body (all models) ^{OS1}

FI66CRWXW/O (no air)..... \$59.00/kit
 FI66CRWXW/A (with air)..... \$59.00/kit

1968-70 B-Body (all models) ^{OS1}

FI68CRWXW/O (no air)..... \$59.00/kit
 FI66CRWXW/A (with air)..... \$59.00/kit

1971-74 Roadrunner, Satellite ^{OS1}

GTX, Charger
 FI71CRXW/O (no air)..... \$59.00/kit
 FI71CRXW/A (with air)..... \$59.00/kit

1970-74 E-Body (all models) ^{OS1}

FI70CBJW/O (no air)..... \$49.00/kit
 FI70CBJW/A (with air)..... \$49.00/kit

1965-68 C-Body (all models) ^{OS1}

FI65CFMPW/A (with air)..... \$69.00/kit

1967-71 Dodge Truck ^{OS1}

FI67CDTW/O (no air)..... \$79.00/kit

1972-80 Dodge Truck ^{OS1}

FI72CDTW/O (no air)..... \$69.00/kit

OEM FIREWALL INSULATION

Firewalls are cut and punched with standard factory holes and are shipped ready-to-install with the appropriate "period" insulation attached.

1965-68 C-Body ^{OS2}

FI65CFMPO (no air)..... \$179.00/pr.
 FI65CFMPO-W/A (with air)..... \$179.00/pr.

1968-70 B-Body ^{OS2}

FI68CRWXO (no air)..... \$179.00/pr.

SOUND DEADENER

This rubber/tar material installs under the carpet to reduce heat and noise. Pre-cut to correct shape and size.

1967-76 A-Body (all models)

SD66CABE \$99.00/ea.

1963-71 C-Body (all models) ^{OS1}

SD65CFMP \$99.00/ea.

1972/80 Dodge Truck ^{OS1}

SD72CDT \$89.00/ea.

SOUND DAMPENING

Kits are designed on current "state-of-the-art" auto acoustic technology, to insulate and control the noise, vibration and heat.

1968-70 B-BODY

Hardtop/Coupe

SD68CRWX-H (Dampening Kit) ^{OS1}..... \$949.00/ea.
 ⚠ Kit includes Body Panel, Cowl, Floor, Roof & Trunk pieces.

SD68CRWX-BPK (Body Panel) ^{OS2}..... \$189.00/ea.

SD68CRWX-CK (Cowl) ^{OS1}..... \$89.00/ea.

SD68CRWX-FK (Floor) ^{OS2}..... \$339.00/ea.

SD68CRWX-RK (Roof) ^{OS2}..... \$189.00/ea.

SD68CRWX-TK (Trunk) ^{OS2}..... \$189.00/ea.

Convertible

SD68CRWX-V (Dampening Kit) ^{OS1}..... \$789.00/ea.

⚠ Kit includes Body Panel, Cowl, Floor & Trunk pieces.

SD68CRWX-VBPK (Body Panel) ^{OS2}..... \$189.00/ea.

SD68CRWX-VCK (Cowl) ^{OS1}..... \$89.00/ea.

SD68CRWX-VFK (Floor) ^{OS2}..... \$339.00/ea.

SD68CRWX-VTK (Trunk) ^{OS2}..... \$189.00/ea.

1971-74 B-BODY

Hardtop Models

SD71CRX-H (Dampening Kit) ^{OS1}..... \$949.00/ea.

⚠ Kit includes Body Panel, Cowl, Floor, Roof & Trunk pieces.

SD71CRX-BPK (Body Panel) ^{OS2}..... \$189.00/ea.

SD71CRX-CK (Cowl) ^{OS1}..... \$89.00/ea.

SD71CRX-FK (Floor) ^{OS2}..... \$339.00/ea.

SD71CRX-RK (Roof) ^{OS2}..... \$189.00/ea.

SD71CRX-TK (Trunk) ^{OS2}..... \$189.00/ea.

DOOR SILL PLATES



Machine stamped aluminum sill plates cover the edge of the carpet securing it to the lower door frame section. Available for 2-door models only. * Do not come with screws, must supply own.

1967-74 A-Body

SP67CBLV \$129.00/pr.

1966-67 B-Body

SP66CRWX \$129.00/pr.

1968-70 B-Body

SP68CRWX \$99.00/pr.

1971-74 B-Body

SP71CRWX \$149.00/pr.

1970-74 E-Body

SP70CBJ (Repro) \$129.00/pr.



Providing the automotive industry
with the world's highest quality
soft trim products and services
RIGHT HERE AT HOME

STILL ASSEMBLED AND
MADE IN THE ★★★★★
USA 

THERE REALLY IS A DIFFERENCE!!

Legendary
AUTO INTERIORS LTD.

www.legendaryautointeriors.com





DASHES, CONSOLES AND ACCESORIES

 facebook.com/legendaryautointeriors

 twitter.com/legendaryautoin

 www.legendaryautointeriors.com

 instagram.com/legendaryautointeriorsltd

 youtube.com/user/legendaryauto

1969-70 DODGE & PLYMOUTH B-BODY DASH PADS

**OEM
style**

**As-Original
Stamped Steel Core**

Available in 6 vibrant colors!!

69-70 White (200)
(also paintable)

69 Saddle (650)

69-70 Black (100)

69 "Dukes" Tan (670)

69 Dark Metallic Blue (330)

69-70 Dark Metallic Green (434)

- Manufactured by Legendary
- Perfect Alignment
- Guaranteed Fit and Quality
- As Original Contours & Features
- Original Factory Look
- Limited Lifetime Warranty

An Industry First From Legendary!!



**Perfect Fit
and Alignment!!
Check out this
test-fit photo!**

1969-70 B-Body (all models) (L5)	
DP69CRWX100 (Black)\$492.00/ea.
DP69CRWX200 (White)\$492.00/ea.
DP69CRWX330 (Dark Met. Blue)\$492.00/ea.
DP69CRWX434 (Dark Met. Green)\$492.00/ea.
DP69CRWX650 (Saddle)\$492.00/ea.
DP69CRWX670 ("Dukes" Tan)\$492.00/ea.

B-BODY DASH PADS

Reproduction dash pads for 1971-74 B-Body models feature original Cologne grain finish. Available in black only.

- 1966-67 B-Body (all models except Charger)**
DP66CRW01 Discontinued
- 1968 B-Body (all models)**
DP68CRWX01 Discontinued
- 1971-74 B-Body (all models)**
DP71CRX01 (Black) \$579.00/ea.

UNDERDASH INSULATION

Die-cut to original specifications, this insulation eliminates underdash noise and vibration.

- 1966-67 B-Body (all models)**
UD66CRWX \$19.00/kit
- 1968-70 B-Body (all models)**
UD68CRWX \$19.00/kit
- 1965-68 C-Body (all models)**
UD65CFMP \$29.00/kit

HEMI CHOKE CABLE

Underdash cable that operates the choke on 1971 Hemi cars. Includes correct foil "CHOKE" applique and firewall grommet.

- 1971 B-Body HEMI**
UD71BE-HEMI \$89.00/ea.

DASH PAD EMBLEMS

Reproduction emblems with adhesive back for ease of installation.

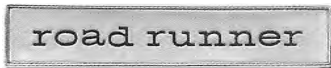

- 1968 Roadrunner**
DP68CR-EMBLEM discontinued
 Also fits outside doors and trunk lid on models without "Decor" package.

"CARB AIR" APPLIQUE

Correct red foil "CARB AIR" applique for underdash cable that manually operates the cold air doors on 1969-1971 fresh air Shaker, Air Grabber, and Ramcharger hoods.

- 1969-70 B-Body "Carb Air" Foil Applique**
UD69BE-CARB \$15.00/ea.

"CHOKE" APPLIQUE

Correct red foil "CHOKE" applique for underdash cable that operates the choke on 1971 Hemi cars.

- 1971 B-Body**
UD71BE-CHOKE \$15.00/ea.

VENT CABLES



Underdash vent cable with correct "square" knob and white VENT marking for 1968-70 Dodge and Plymouth B-Bodies without AC.

- 1968-70 B-Body**
UD68B-VCL (left hand) \$79.00/ea.
UD68B-VCR (right hand) \$79.00/ea.



Underdash vent cable with correct round knob knurled edge for 1971-74 B-Bodies without AC.

- 1971-74 B-Body**
UD71B-VCL (left hand) \$79.00/ea.
UD71B-VCR (right hand) \$79.00/ea.

FRESH AIR HOOD CABLES



Cables that operate the cold and warm air doors on the 1969-70 Ramcharger (Dodge B-Body) and 1969 Air Grabber (Ply. B-body) hoods. Includes foil "CARB AIR" applique and firewall grommet.

- 1969-70 B-Body Under Dash Cable**
UD69B-HCD \$79.00/ea.
- 1969-70 B-Body Under Hood Cable**
UD69B-HC \$29.00/ea.

CONSOLE SHIFTER SLIDE



Reproduction shifter slide seal for 1966-1970 B-Body models with console shifted automatics.

- TN66AB-SLIDE** \$21.00/ea.

LOWER STEERING COLUMN COVER



For 1968-69 B-Body. Hardware is included

- 1968-69 B-Body**
TA68B-CVR \$69.00/ea.
- 1970 Non Rallye**
TA70B-CVR \$59.00/ea.
- 1970 Rallye**
TA70B-RYECVR \$69.00/ea.

4-SPEED CONSOLE SIDE COVER



Reproduction console side cover for 1966-70 B & C-Body models (except '66 Charger) with manual transmission. Molded in black plastic (originals were fiberboard) to original specifications.

- CS66CFMPRWX4SP** \$99.00/ea.

PILLAR POST MOLDINGS



Reproduction plastic pillar post moldings for 1968-70 B-Body and 1971-74 B-Body models.

- 1968-70 B-Body**
PP68CRWX100 \$169.00/pr.
- 1971-74 B-Body**
PP71CRXM100-2 \$169.00/pr.
 2 screw model that fits through January of 1971 models
PP71CRXM100-1 \$169.00/pr.
 1 screw model that fits later 1971 and all 1972-74 models
 Quality is fair. Customer Approval Only. Item is Non Returnable/Non Refundable

CONSOLE CARPET KITS

Carpet kits for B-Body bucket seat interiors with center console option. Ready to install kits come with fully bound carpet attached to die-cut panel board as original where applicable by year.

B-BODY MODELS

1962-63 B-Body (all models)

CC62CFPR(C).....\$71.00/kit
 Please refer to carpet color selection page to specify carpet color at time of order.

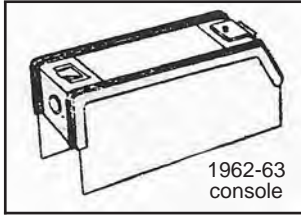

1962-63 console

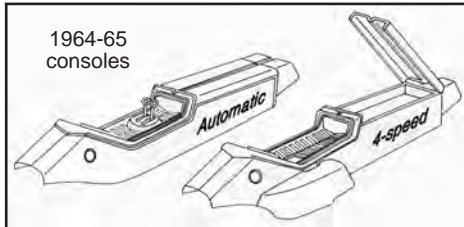

1964-65 consoles



1964 B-Body automatic console carpet

1964 B-Body (all models)

CC64CFPRWA(C) (automatic).....\$146.00/kit
CC64CFPRWS(C) (manual).....\$146.00/kit
 Please refer to carpet color selection page to specify carpet color at time of order.

1965 B-Body (all models)

CC65CFPRWA(C) (automatic).....\$146.00/kit
CC65CFPRWS(C) (manual).....\$146.00/kit



1966-70 B-Body 4-speed

1966-70 B-Body (all models)

CC66CRWA(C) (automatic).....\$71.00/kit
CC66CRWXS(C) (manual) (shown)\$89.00/kit
 Please refer to carpet color selection page to specify carpet color at time of order.
 Will not work for 1966-67 Charger.

C-BODY MODELS

1963-64 Chrysler 300 & Newport

CC63CM(C) (automatic).....\$146.00/kit
 Please specify carpet color at time of order.

1965 Chrysler B-Body

CC65CFPRWA(C) (automatic).....\$146.00/kit
CC65CFPRWS(C) (manual).....\$146.00/kit
 Please specify carpet color at time of order.

1965 Chrysler C-Body

CC65CMA(C) (automatic).....\$146.00/kit
CC65CMA(C) (manual).....\$146.00/kit
 Please specify carpet color at time of order.

1966-70 Chrysler 300, Monaco & Polara Newport & Sport Fury

CC66CRWA(C) (automatic)\$71.00/kit
CC66CRWXS(C) (manual).....\$71.00/kit
 Please specify carpet color at time of order.

WOODGRAIN CONSOLE INSERTS



Die-cut vinyl woodgrain inserts for automatic and 4-speed models made in original grain and color. Adhesive backing makes them easy to install.

B-BODY MODELS

1968-70 (all models)

WC68BA (automatic)\$29.00/ea.
WC68BS (manual)\$29.00/ea.

1971-74 (all models)

WC70EBA (automatic).....\$30.00/ea.
WC70EBS (manual).....\$30.00/ea.

66-70 B-BODY CONSOLE TRIM

1966-70 B-Body

CS66B-TRIM (automatic).....\$169.00/ea
CS66B-TRIM4SP (manual).....\$169.00/ea

67-70 B-BODY CONSOLES

Injection mold plastic console body for 1967-70 B-Body models. Available for automatic and 4-speed models. Molded in black plastic to original specifications and correct grain. Original hardware must be reused. For console carpet kits please see above.

1967-70 B-Body ^{OS1}

CS67CRWXA (Automatic).....\$299.00/ea.
CS67CRWXS (4-speed).....\$299.00/ea.



Automatic



4-speed

71-74 B-BODY CONSOLES

Injection mold plastic console body for 1971-74 B-Body models. Available for automatic and 4-speed models. Molded in black plastic to original specifications and correct grain. Original hardware must be reused. For console carpet kits please see above.

1971-74 B-Body ^{OS1}

CS71BEA (Automatic).....\$299.00/ea.
CS71BES (4-Speed).....\$299.00/ea.



1970

1971



CONSOLE LIGHT LENSES



Round plastic console light lenses for 1964-70 B-Body models equipped with center console.

LL64B-CON \$15.00/pr.

DOME LIGHT LENS



Round plastic dome light lens for 1966-74 B & C-Body models.

LL66ABCE-DOME \$10.00/ea.

MAP LIGHT LENS



Plastic map light lens for 1967-70 B-Body models. Installation hardware included.

LL67AB-MAPLENS \$19.00/ea.

COURTESY LIGHT LENSES

Round plastic courtesy light lenses located on the sail panels for 1964-66 B & C-Body models.

LL65BC-CRTSY \$29.00/pr.

REAR WINDOW TRIM



Reproduction molded plastic trim replaces frequently cracked or broken original trim. Available in black only or can be painted to match other interior colors.

1964-65 B-Body ^{OS1}

(2 & 4-door Hardtop & Sedan)

RT64C-B03 (3 pc.) \$ 79.00/kit

1968-70 Roadrunner, Satellite & GTX ^{OS1}

RT68CR03 (3 pc.) \$ 99.00/kit

RT68CR04 (4 pc.) \$109.00/kit

RT68CRLP (lower center piece) \$ 49.00/ea.

1968-70 Coronet & Coronet R/T ^{OS1}

RT68CW03 (3 pc.) \$ 99.00/kit

RT68CW05 (5 pc.) \$109.00/kit

RT68CW06 (6 pc.) \$129.00/ea.

RT68CWLC (lower corners) \$ 39.00/ea.

RT68CWLP (lower center piece) \$ 49.00/ea.

1968-70 Charger & Charger R/T ^{OS1}

RT68CX04 (4 pc.) \$99.00/kit

RT68CX06 (6 pc.) \$129.00/kit

RT68CXLC (lower corners) \$ 49.00/ea.

1969 Charger 500 & Daytona ^{OS1}

RT69CX03 (3 pc.) \$ 99.00/kit

RT69CX06 (6 pc.) \$129.00/kit

68-70 HORN BUTTON



Horn button for 1968-70 B-Body models with woodgrain steering wheels. Original grain texture. Available in black only but can be dyed to match interior colors.

1968-70 B-Body (all models)

SW68C-HB (shown) \$69.00/ea.

RADIO TRIM PLATES

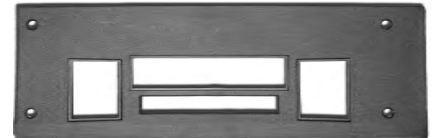

Add the finishing touch to your dash with these factory radio trim plates. Finished in flat black these trim plates fit all factory installed AM and AM/FM radios.

1968-69 Roadrunner, Satellite & GTX

RB68CR (shown) \$79.00/ea.

1970 B-Body (with Rallye gauges)

RB70CRWX \$99.00/ea.

DASH VENTS

Exact duplicates of the original dash vents found on the top portion of the dash. Available in black only but can be painted to match interior colors. Fastening nuts included.



1962-65 B-Body (all models)

DP62C-VENT \$89.00/pr.

1968-70 B-Body (all models)

DP68CRWX-VENT \$89.00/pr.

1972-80 Dodge Truck

DP62C-VENT \$89.00/pr.

DASH VENT HOSE KITS

Dash vents and fastening nuts (same as above) with new reproduction vent hoses. Kits include 2 vents with fastening nuts and 2 hoses with clips.



1962-65 B-Body (all models)

DP62C-VHKIT \$139.00/pr.

1968-70 B-Body (all models)

DP68CRWX-VHKIT \$139.00/pr.

1972-80 Dodge Truck

DP62C-VHKIT \$139.00/pr.

GLOVEBOX LATCH

New latch assembly for 1971-1974 B-Body models. These latches have the correct fit and function as the originals.



GB71B-LATCH discontinued

GLOVEBOX LINERS

Glovebox liners are die-cut and pre-stapled with mounting hardware attached for easy installation. Fuse box doors included where applicable.



B-BODY MODELS

1962 Polara, Fury & Sport Fury	
GB62CFP	\$29.00/ea.
1963 Polara, Belvedere, Fury & Sport Fury	
GB63CFPR	\$39.00/ea.
1964 Polara, Belvedere, Fury & Sport Fury	
GB64CFRP (no air)	\$29.00/ea.
GB64CFRPA (with air)	\$29.00/ea.
1965 Belvedere, Satellite & Coronet	
GB65CRW	\$29.00/ea.
1966-67 Coronet & Charger	
GB66WX	\$29.00/ea.
1966-67 Belvedere, Satellite & GTX	
GB66R	\$29.00/ea.
1968 Coronet, Charger, Roadrunner & GTX	
GB68RWX	\$29.00/ea.
1969 Coronet, Charger, Roadrunner & GTX	
GB69RWX	\$29.00/ea.
1970 Coronet, Charger, Roadrunner & GTX	
GB70RWX	\$29.00/ea.

C-BODY MODELS

1960-62 Chrysler 300 & Newport	
GB60CM (no air)	\$49.00/ea.
GB60CMA (with air)	\$49.00/ea.
1963-64 Chrysler 300 & Newport	
GB63CM (no air)	\$49.00/ea.
GB63CMA (with air)	\$49.00/ea.
1965-66 Fury & Sport Fury	
GB65CF	\$29.00/ea.
1965-66 Polara & Monaco	
GB65CP (no air)	\$29.00/ea.
GB65CPA (with air)	\$39.00/ea.
1967-68 Chrysler 300 & Newport	
GB67CM	\$49.00/ea.
1967-68 Fury & Sport Fury	
GB67CF	\$39.00/ea.
1967-68 Polara & Monaco	
GB67CP	\$39.00/ea.
1969-70 Chrysler 300	
GB69CM	\$49.00/ea.
1969-72 Fury & Sport Fury	
GB69CF (no air)	\$39.00/ea.
GB69CFA (with air)	\$39.00/ea.

DODGE TRUCK & VAN

1961-66 Dodge Truck	
GB61CDT	\$29.00/ea.
1967-71 Dodge Truck	
GB67CDT	\$29.00/ea.
1964-70 A-100 Van	
GB64CDV	\$29.00/ea.

GLOVEBOX EMBLEMS

Reproduction emblems with adhesive back for ease of installation.

1966-67 Belvedere II
GB66CR2-EMBLEM discontinued



1966-67 Satellite
GB66CR-EMBLEM discontinued



1967 GTX
GB67CR-EMBLEM discontinued



AUTOMATIC SHIFTER KNOB



Reproduction woodgrain shifter knob used in selected 1969-74 B-Body models with console-shifted automatics. Black push button and spring included in kit.

TN69AABE-SHIFT \$79.00/kit

4-SPEED SHIFTER KNOB



Woodgrain shifter knob made of plastic for 1968-1969 B-Body 4-speed models. Features a correct woodgrain texture and 4-speed pattern.

TN68AB4SP-BALL \$79.00/ea.





Providing the automotive industry
with the world's highest quality
soft trim products and services
RIGHT HERE AT HOME

STILL ASSEMBLED AND
MADE IN THE ★★★★★
USA 

THERE REALLY IS A DIFFERENCE!!

Legendary
AUTO INTERIORS LTD.®

www.legendaryautointeriors.com



Chrysler, Dodge, Plymouth

SHIFTER BOOTS & BEZEL

Rubber shifter boots and bezels as original. Upper boots are for models equipped with center consoles while lower boots are for manual transmission models without a center console. Lower shift boots use a bezel that feature a chrome finish as the originals.



1966-69 B-Body (all models)
TN66B-BOOT-U (with console)...DISCONTINUED



1968-69 B-Body (Hurst equipped models)
TN68B-BOOT-L (w/o console)..... \$99.00/ea.



1971-72 B-Body (all models)
TN70BE-BOOT-L (w/o console)..... \$69.00/ea.
⚠ Not correct for 1971-72 B-Body models with bench seat or buckets with center fold-down armrest.



1968-70 B-Body (all models)
TN68B-BOOTBEZ (w/o console)..... \$29.00/ea.



1971-72 B-Body (all models)
TN70BE-BOOTBEZ (w/o console)..... \$29.00/ea.

PEDAL PADS & BEZELS

Reproduction pedal pads and bezels for accelerators, brake/clutch and parking brake on B-Body models.

ACCELERATORS & BEZELS



1962-65 B-Body
PB63AB-A (pad w/ raised dots).....\$59.00/ea.

1966-70 B-Body
PB66B-A (pad) (shown).....\$79.00/ea.
PB66B-ABEZ (bezel).....\$15.00/ea.

AUTOMATIC BRAKE PADS & BEZELS



1962-65 B-Body
PB63ABA-B (pad w/ raised dots) \$39.00/ea.

1966-70 B-Body
PB66ABA-B (pad) (shown).....\$39.00/ea.
PB66ABA-BBEZ (bezel) (shown).....\$29.00/ea.

1971-72 B-Body
PB70BEA-B (pad).....\$19.00/ea.
PB70BEA-BBEZ (bezel).....\$19.00/ea.

4-SPEED CLUTCH/BRAKE PADS & BEZELS



1962-65 B-Body
PB63AB4SP-B/C (pad w/ dots) \$19.00/ea.

1966-70 B-Body
PB66AB4SP-B/C (pad).....\$39.00/pr.
PB66AB4SP-B/CBEZ (bezel) (shown).. \$29.00/pr.

1971-72 B-Body
PB70BE4SP-B/C (pad) (shown).....\$29.00/ea.
PB70BE4SP-B/CBEZ (bezel).....\$15.00/ea.

1973-74 B-Body
PB71ABE4SP-B/C (pad) \$10.00/ea.

PARKING BRAKE PADS



1962-65 B-Body
PB63AB-P (pad w/ dots) (shown).....\$19.00/ea.

1966-70 B-Body
PB66AB-P (pad)\$29.00/ea.
PB66AB-PBEZ (bezel) (shown).....\$15.00/ea.

1971-72 B-Body
PB70BE-P (pad).....\$29.00/ea.
PB70BE-PBEZ (bezel).....\$15.00/ea.

SHIFTER BOOTS & BEZELS



Clutch release fork boot for 1964-74 B & C-Body 4-Speed & 3-Speed column shift

1964-74 A,B,C & E-Body
TN64ABCE-BOOT \$39.00/ea.

PISTOL GRIP SHIFTER & LENS







Reproduction injection-molded plastic pistol grip shifter for 1970-74 B 4-speed models. Pistol and lens sold separately.

TN70BE4SP-GRIP \$89.00/ea.
TNGRIPLENS \$15.00/ea.



HEADLINERS AND TRIM ACCESORIES

 facebook.com/legendaryautointeriors
 twitter.com/legendaryautoin

 www.legendaryautointeriors.com
 instagram.com/legendaryautointeriorsltd
 youtube.com/user/legendaryauto

Headliner Grains and Colors

Legendary Auto Interiors headliners are manufactured to original specifications and are available in a variety of colors in Perforated or Non-Perforated pattern. Each headliner is assembled with heavy-duty stitching.

If your year/model is not listed please contact our sales department for assistance on availability. Please specify perforated or non-perforated at time of order. Sample approval is highly recommended for colors other than black.

STANDARD style

Non-Perforated

01 Black	02 White	03 Red	07 Dark Blue
11 Medium Blue	13 Dark Green	17 Buckskin	18 Light Blue
20 Bright Red	31 Maroon	38 Sandalwood	98 Brown

Perforated

01 Black	02 White	03 Red	07 Dark Blue
11 Medium Blue	13 Dark Green	17 Buckskin	18 Light Blue
20 Bright Red	31 Maroon	38 Sandalwood	98 Brown

OEM style

Legendary Auto Interiors, Ltd. is pleased to announce another first in the industry. "As Original" headliners and sail panels are now available for 1965-66 and 1969-72 Dodge, Plymouth and Chrysler cars. All new headliner styles have a heavier cotton/poly cloth backing with more vibrant colors and finishes like the ORIGINAL!! This will assure longevity to these new products as the vinyl and backing are much higher quality than other vinyls offered in today's automotive marketplace.

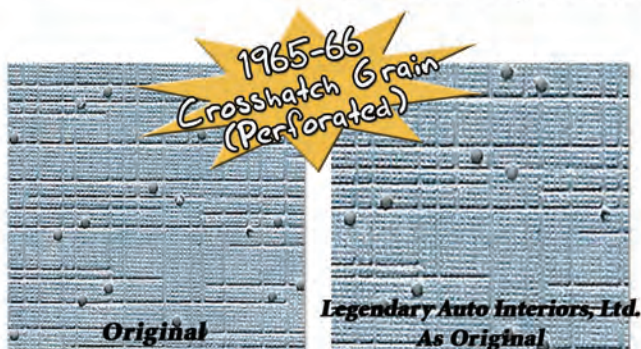

101 Black	102 White
111 Light Met. Blue	121 Metallic Red

101 Black	102 White	107 Dark Blue
110 Bright Blue	113 Dark Green	122 Burnt Orange

HEADLINERS

B-BODY MODELS

1963 Polara 500 & Dodge 440

Hardtop - (Perforated Grain)
 HL63CP01 (Black)..... \$169.00/ea.
 HL63CP02 (White)..... \$169.00/ea.

1963 Dodge 330 & 440

2 & 4 Door Sedan - (Perforated Grain)
 HL63D330/01 (Black)..... \$169.00/ea.
 HL63D330/02 (White)..... \$169.00/ea.

1963 Belvedere, Fury & Sport Fury

Hardtop - (Perforated Grain)
 HL63CF01 (Black)..... \$169.00/ea.
 HL63CF02 (White)..... \$169.00/ea.

☞ For 1963 Sport Fury with black & red interiors, the headliners were always white. Any other color is considered custom. No custom charge will be applied.

1964 Dodge 330 & 440

2 & 4 Door Sedan - (Perforated Grain)
 HL64D330/01 (Black)..... \$169.00/ea.
 HL64D330/02 (White)..... \$169.00/ea.

1964 Polara, Polara 500 & Dodge 440

1964 Belvedere, Fury & Sport Fury

1965 Belvedere II & Satellite
Hardtop - (Perforated Grain)
 HL64CFPR01 (Black)..... \$169.00/ea.
 HL64CFPR02 (White)..... \$169.00/ea.
Hardtop - OEM Style - (Crosshatch Grain)
 HL65CFPR101 (Black)..... \$255.00/ea.
 HL65CFPR102 (White)..... \$255.00/ea.

1964 Savoy, Belvedere & Fury

1965 Belvedere I & II
2 & 4 Door Sedan (Perforated Grain)
 HL64CFPRW01 (Black)..... \$169.00/ea.
 HL64CFPRW02 (White)..... \$169.00/ea.
 HL64CFPRW11 (Medium Blue)..... \$169.00/ea.
 HL64CFPRW20 (Bright Red)..... \$169.00/ea.

2 & 4 Door Sedan OEM Style

(Crosshatch Grain)
 HL65CFPRW101 (Black)..... \$255.00/ea.
 HL65CFPRW102 (White)..... \$255.00/ea.
 HL65CFPRW111 (Light Metallic Blue)..... \$255.00/ea.

1965 Coronet 440 & 500

Hardtop - (Perforated Grain)
 HL65CW01 (Black)..... \$169.00/ea.
 HL65CW02 (White)..... \$169.00/ea.
 HL65CW11 (Medium Blue)..... \$169.00/ea.
Hardtop - OEM Style - (Crosshatch Grain)
 HL65CW101 (Black)..... \$255.00/ea.
 HL65CW102 (White)..... \$255.00/ea.
 HL65CW111 (Light Metallic Blue)..... \$255.00/ea.
 HL65CW121 (Metallic Red)..... \$255.00/ea.

1966-67 Coronet, Belvedere II, Satellite & GTX

Hardtop - (Perforated Grain)
 HL66CRW01 (Black)..... \$169.00/ea.
 HL66CRW02 (White)..... \$169.00/ea.
 HL66CRW03 (Red)..... \$169.00/ea.
 HL66CRW07 (Dark Blue)..... \$169.00/ea.
 HL66CRW11 (Medium Blue)..... \$169.00/ea.
Hardtop - OEM Style - (Crosshatch Grain)
 HL66CRW101 (Black)..... \$255.00/ea.
 HL66CRW102 (White)..... \$255.00/ea.
 HL66CRW111 (Light Metallic Blue)..... \$255.00/ea.
 HL66CRW121 (Metallic Red)..... \$255.00/ea.

1966-67 Coronet, Belvedere I & II

2 & 4 Door Sedan 4 Bow - (Perforated Grain)
 HL66CR401 (Black)..... \$169.00/ea.
 HL66CR402 (White)..... \$169.00/ea.

4 Bow - OEM Style - (Crosshatch Grain)
 HL66CR4101 (Black)..... \$255.00/ea.
 HL66CR4102 (White)..... \$255.00/ea.
 HL66CR4111 (Light Metallic Blue)..... \$255.00/ea.
 HL66CR4121 (Metallic Red)..... \$255.00/ea.

2 & 4 Door Sedan 5 Bow - (Perforated Grain)
 HL66CR501 (Black)..... \$169.00/ea.
 HL66CR502 (White)..... \$169.00/ea.

1966-67 Coronet, Belvedere I & II

5 Bow - OEM Style - (Crosshatch Grain)
 HL66CR5101 (Black)..... \$255.00/ea.
 HL66CR5102 (White)..... \$255.00/ea.
 HL66CR5111 (Light Metallic Blue)..... \$255.00/ea.
 HL66CR5121 (Metallic Red)..... \$255.00/ea.

☞ For 1967 models please specify 4 or 5-bows.

1968-70 Charger

Hardtop - (Perforated Grain)
 HL68CRWX01 (Black)..... \$169.00/ea.
 HL68CRWX02 (White)..... \$169.00/ea.
 HL68CRWX03 (Red)..... \$169.00/ea.
 HL68CRWX07 (Dark Blue)..... \$169.00/ea.
 HL68CRWX11 (Medium Blue)..... \$169.00/ea.
 HL68CRWX13 (Dark Green)..... \$169.00/ea.
 HL68CRWX17 (Buckskin)..... \$169.00/ea.
 HL68CRWX31 (Maroon)..... \$169.00/ea.
 HL68CRWX38 (Sandalwood)..... \$169.00/ea.
 HL68CRWX98 (Dark Brown)..... \$169.00/ea.
Hardtop - OEM Style - (Fine Pembroke Grain)
 HL68CRWX101 (Black)..... \$209.00/ea.
 HL68CRWX102 (White)..... \$209.00/ea.
 HL68CRWX130 (Dark Blue)..... \$209.00/ea.
 HL68CRWX113 (Dark Green)..... \$209.00/ea.
 HL68CRWX122 (Burnt Orange)..... \$209.00/ea.

1969 Charger 500 & Daytona

Hardtop - (Perforated Grain)
 HL69CXDAY01 (Black)..... \$169.00/ea.
 HL69CXDAY02 (White)..... \$169.00/ea.
 HL69CXDAY03 (Red)..... \$169.00/ea.
 HL69CXDAY07 (Dark Blue)..... \$169.00/ea.
 HL69CXDAY13 (Dark Green)..... \$169.00/ea.
Hardtop - OEM Style - (Fine Pembroke Grain)
 HL69CXDAY101 (Black)..... \$209.00/ea.
 HL69CXDAY102 (White)..... \$209.00/ea.
 HL69CXDAY107 (Dark Blue)..... \$209.00/ea.
 HL69CXDAY113 (Dark Green)..... \$209.00/ea.

1969-70 Charger (with factory sunroof)

Hardtop - (Perforated Grain)
 HL69CXSun03 (Red)..... \$169.00/ea.
 HL69CXSun17 (Buckskin)..... \$169.00/ea.
 HL69CXSun98 (Dark Brown)..... \$169.00/ea.
Hardtop - OEM Style - (Fine Pembroke Grain)
 HL69CXSun101 (Black)..... \$270.00/ea.
 HL69CXSun102 (White)..... \$270.00/ea.
 HL69CXSun107 (Dark Blue)..... \$270.00/ea.
 HL69CXSun113 (Dark Green)..... \$270.00/ea.
 HL69CXSun122 (Burnt Orange)..... \$270.00/ea.

1968 Coronet, Roadrunner, Satellite & GTX

Hardtop - (Perforated Grain)
 HL68CRWX01 (Black)..... \$169.00/ea.
 HL68CRWX02 (White)..... \$169.00/ea.
 HL68CRWX03 (Red)..... \$169.00/ea.
 HL68CRWX07 (Dark Blue)..... \$169.00/ea.
 HL68CRWX11 (Medium Blue)..... \$169.00/ea.
 HL68CRWX13 (Dark Green)..... \$169.00/ea.
 HL68CRWX17 (Buckskin)..... \$169.00/ea.
 HL68CRWX31 (Maroon)..... \$169.00/ea.
 HL68CRWX38 (Sandalwood)..... \$169.00/ea.
 HL68CRWX98 (Dark Brown)..... \$169.00/ea.

Hardtop - OEM Style - (Fine Pembroke Grain)

HL68CRWX101 (Black)..... \$209.00/ea.
 HL68CRWX102 (White)..... \$209.00/ea.
 HL68CRWX107 (Dark Blue)..... \$209.00/ea.
 HL68CRWX113 (Dark Green)..... \$209.00/ea.
 HL68CRWX122 (Burnt Orange)..... \$209.00/ea.

1969-70 Coronet, Roadrunner, Satellite & GTX

Hardtop - (Perforated Grain)
 HL69CRW01 (Black)..... \$169.00/ea.
 HL69CRW02 (White)..... \$169.00/ea.
 HL69CRW03 (Red)..... \$169.00/ea.
 HL69CRW07 (Dark Blue)..... \$169.00/ea.
 HL69CRW13 (Dark Green)..... \$169.00/ea.
 HL69CRW17 (Buckskin)..... \$169.00/ea.
 HL69CRW98 (Dark Brown)..... \$169.00/ea.

1969-70 Coronet, Roadrunner, Satellite & GTX

Hardtop - OEM Style - (Fine Pembroke Grain)
 HL69CRW101 (Black)..... \$209.00/ea.
 HL69CRW102 (White)..... \$209.00/ea.
 HL69CRW107 (Dark Blue)..... \$209.00/ea.
 HL69CRW122 (Burnt Orange)..... \$209.00/ea.

1970 Superbird

Hardtop - (Perforated Grain)
 HL70SBIRD01 (Black)..... \$169.00/ea.
Hardtop - OEM Style - (Fine Pembroke Grain)
 HL70SBIRD101 (Black)..... \$209.00/ea.
 HL70SBIRD102 (White)..... \$209.00/ea.

1971-72 Charger & Roadrunner (w/ factory sunroof)

2 Bow - (Perforated Grain)
 HL71CRXSUN01 (Black)..... \$169.00/ea.
 HL71CRXSUN02 (White)..... \$169.00/ea.
 HL71CRXSUN07 (Dark Blue)..... \$169.00/ea.
 HL71CRXSUN13 (Dark Green)..... \$169.00/ea.
 HL71CRXSUN38 (Sandalwood)..... \$169.00/ea.
 HL71CRXSUN98 (Dark Brown)..... \$169.00/ea.
2 Bow - OEM Style - (Fine Pembroke Grain)
 HL71CRXSUN101 (Black)..... \$169.00/ea.
 HL71CRXSUN102 (White)..... \$169.00/ea.
 HL71CRXSUN107 (Dark Blue)..... \$169.00/ea.
 HL71CRXSUN113 (Dark Green)..... \$169.00/ea.
2 Bow - (Non-Perforated Grain) (1972 only)
 HL71CRXSUN01NP (Black)..... \$169.00/ea.
 HL71CRXSUN02NP (White)..... \$169.00/ea.
 HL71CRXSUN07NP (Dark Blue)..... \$169.00/ea.
 HL71CRXSUN13NP (Medium Blue)..... \$169.00/ea.
 HL71CRXSUN13NP (Dark Green)..... \$169.00/ea.
 HL71CRXSUN38NP (Sandalwood)..... \$169.00/ea.
 HL71CRXSUN98NP (Dark Brown)..... \$169.00/ea.

HEADLINERS CONT.

B-BODY MODELS CONT.

1971-74 Charger, Roadrunner, Satellite & GTX 4 Bow - (Perforated Grain)

HL71CRX401 (Black).....	\$169.00/ea.
HL71CRX402 (White).....	\$169.00/ea.
HL71CRX407 (Dark Blue).....	\$169.00/ea.
HL71CRX413 (Dark Green).....	\$169.00/ea.
HL71CRX438 (Sandalwood).....	\$169.00/ea.
HL71CRX498 (Dark Brown).....	\$169.00/ea.

4 Bow - (Non-Perforated Grain)

HL71CRX401NP (Black).....	\$169.00/ea.
HL71CRX402NP (White).....	\$169.00/ea.
HL71CRX407NP (Dark Blue).....	\$169.00/ea.
HL71CRX411NP (Med Blue).....	\$169.00/ea.
HL71CRX413NP (Dark Green).....	\$169.00/ea.
HL71CRX438NP (Sandalwood).....	\$169.00/ea.
HL71CRX498NP (Brown).....	\$169.00/ea.

4 Bow - OEM Style - (Fine Pembroke Grain)

HL71CRX4101 (Black).....	\$209.00/ea.
HL71CRX4102 (White).....	\$209.00/ea.
HL71CRX4107 (Dark Blue).....	\$209.00/ea.
HL71CRX4113 (Dark Green).....	\$209.00/ea.

6 Bow - (Perforated Grain)

HL71CRX601 (Black).....	\$169.00/ea.
HL71CRX602 (White).....	\$169.00/ea.
HL71CRX607 (Dark Blue).....	\$169.00/ea.
HL71CRX613 (Dark Green).....	\$169.00/ea.
HL71CRX638 (Sandalwood).....	\$169.00/ea.
HL71CRX698 (Dark Brown).....	\$169.00/ea.

6 Bow - OEM Style - (Fine Pembroke Grain)

HL71CRX6101 (Black).....	\$209.00/ea.
HL71CRX6102 (White).....	\$209.00/ea.
HL71CRX6107 (Dark Blue).....	\$209.00/ea.
HL71CRX6113 (Dark Green).....	\$209.00/ea.

☞ For 1971 models please specify 4 or 6-bows.

1973-74 Charger & Roadrunner (w/ factory sunroof)

2 Bow - (Non-Perforated Grain)

HL73CRXSUN01NP (Black).....	\$169.00/ea.
HL73CRXSUN02NP (White).....	\$169.00/ea.
HL73CRXSUN07NP (Dark Blue).....	\$169.00/ea.
HL73CRXSUN11NP (Medium Blue).....	\$169.00/ea.
HL73CRXSUN13NP (Dark Green).....	\$169.00/ea.
HL73CRXSUN38NP (Sandalwood).....	\$169.00/ea.

C-BODY MODELS

1963 Chrysler 300

2 Door Hardtop - (Perforated Grain)

HL63CM18 (Light Blue).....	\$174.00/ea.
----------------------------	--------------

1964 Chrysler 300

2 Door Hardtop - (Perforated Grain)

HL64C300K01 (Black).....	\$279.00/ea.
HL64C300K02 (White).....	\$279.00/ea.

1965 Chrysler 300 & Newport

2 Door Hardtop - (Perforated Grain)

HL65CM01 (Black).....	\$198.00/ea.
HL65CM02 (White).....	\$198.00/ea.
HL65CM17 (Buckskin).....	\$198.00/ea.

1965 Chrysler 300 & Newport

2 Door Hardtop - OEM Style

(Crosshatch Grain)

HL65CM101 (Black).....	\$270.00/ea.
HL65CM102 (White).....	\$270.00/ea.
HL65CM111 (Light Metallic Blue).....	\$270.00/ea.
HL65CM121 (Metallic Red).....	\$270.00/ea.

C-BODY MODELS CONT.

1966 Chrysler 300

2 Door Hardtop - (Perforated Grain)

HL66CM01 (Black).....	\$198.00/ea.
HL66CM02 (White).....	\$198.00/ea.
HL66CM03 (Red).....	\$198.00/ea.
HL66CM07 (Dark Blue).....	\$198.00/ea.

2 Door Hardtop - OEM Style

(Crosshatch Grain)

HL66CM101 (Black).....	\$270.00/ea.
HL66CM102 (White).....	\$270.00/ea.
HL66CM111 (Light Metallic Blue).....	\$270.00/ea.
HL66CM121 (Metallic Red).....	\$270.00/ea.

1967 Chrysler 300, Newport & New Yorker

2 Door Hardtop - (Perforated Grain)

HL67CM01 (Black).....	\$198.00/ea.
HL67CM02 (White).....	\$198.00/ea.
HL67CM03 (Red).....	\$198.00/ea.
HL67CM11 (Medium Blue).....	\$198.00/ea.

1968 Chrysler 300, Newport & New Yorker

2 Door Hardtop - (Perforated Grain)

HL68CM01 (Black).....	\$198.00/ea.
HL68CM02 (White).....	\$198.00/ea.
HL68CM11 (Medium Blue).....	\$198.00/ea.
HL68CM31 (Maroon).....	\$198.00/ea.

1965 Polara, 880 Custom & Monaco

1965 Fury III & Sport Fury

4 Bow Hardtop - (Perforated Grain)

HL65CFP401 (Black).....	\$198.00/ea.
HL65CFP402 (White).....	\$198.00/ea.
HL65CFP403 (Red).....	\$198.00/ea.
HL65CFP407 (Dark Blue).....	\$198.00/ea.
HL65CFP411 (Medium Blue).....	\$198.00/ea.
HL65CFP417 (Buckskin).....	\$198.00/ea.
HL65CFP418 (Light Blue).....	\$198.00/ea.
HL65CFP431 (Maroon).....	\$198.00/ea.

4 Bow Hardtop - OEM Style

(Crosshatch Grain)

HL65CFP4101 (Black).....	\$255.00/ea.
HL65CFP4111 (Light Metallic Blue).....	\$255.00/ea.
HL65CFP4121 (Metallic Red).....	\$255.00/ea.

1966 Polara & Monaco

1966 Fury III & Sport Fury

4 Bow Hardtop - (Perforated Grain)

HL66CFP401 (Black).....	\$198.00/ea.
HL66CFP402 (White).....	\$198.00/ea.
HL66CFP403 (Red).....	\$198.00/ea.
HL66CFP407 (Dark Blue).....	\$198.00/ea.
HL66CFP411 (Medium Blue).....	\$198.00/ea.
HL66CFP413 (Dark Green).....	\$198.00/ea.
HL66CFP417 (Buckskin).....	\$198.00/ea.
HL66CFP431 (Maroon).....	\$198.00/ea.

1966 Polara & Monaco

1966 Fury III & Sport Fury

4 Bow Hardtop - OEM Style

(Crosshatch Grain)

HL66CFP4101 (Black).....	\$270.00/ea.
HL66CFP4111 (Light Metallic Blue).....	\$270.00/ea.
HL66CFP4121 (Metallic Red).....	\$270.00/ea.

5 Bow Hardtop - (Perforated Grain)4

HL66CFP501 (Black).....	\$198.00/ea.
HL66CFP502 (White).....	\$198.00/ea.
HL66CFP503 (Red).....	\$198.00/ea.
HL66CFP507 (Dark Blue).....	\$198.00/ea.
HL66CFP511 (Medium Blue).....	\$198.00/ea.
HL66CFP513 (Dark Green).....	\$198.00/ea.

C-BODY MODELS CONT.

1966 Polara & Monaco

1966 Fury III & Sport Fury

5 Bow Hardtop - OEM Style

(Crosshatch Grain)

HL66CFP5111 (Light Metallic Blue) ...	\$270.00/ea.
---------------------------------------	--------------

☞ Please specify 4 or 5 bows at time of order.

1967 Fury III & Sport Fury

Hardtop - (Perforated Grain)

HL67CFH01 (Black).....	\$198.00/ea.
------------------------	--------------

Hardtop - OEM Style - (Fine Pembroke Grain)

HL67CFH101 (Black).....	\$270.00/ea.
HL67CFH102 (White).....	\$270.00/ea.
HL67CFH107 (Dark Blue).....	\$270.00/ea.

Fastop - OEM Style - (Fine Pembroke Grain)

HL67CFF101 (Black).....	\$270.00/ea.
HL67CFF102 (White).....	\$270.00/ea.
HL67CFF107 (Dark Blue).....	\$270.00/ea.
HL67CFF110 (Bright Blue).....	\$270.00/ea.
HL67CFF113 (Dark Green).....	\$270.00/ea.

1968 Polara & Monaco

Hardtop - (Perforated Grain)

HL68CP01 (Black).....	\$198.00/ea.
-----------------------	--------------

HL68CP07 (Dark Blue).....	\$198.00/ea.
---------------------------	--------------

HL68CP11 (Medium Blue).....	\$198.00/ea.
-----------------------------	--------------

Hardtop - OEM Style - (Fine Pembroke Grain)

HL68CP101 (Black).....	\$270.00/ea.
------------------------	--------------

HL68CP102 (White).....	\$270.00/ea.
------------------------	--------------

HL68CP107 (Dark Blue).....	\$270.00/ea.
----------------------------	--------------

HL68CP110 (Bright Blue).....	\$270.00/ea.
------------------------------	--------------

HL68CP113 (Dark Green).....	\$270.00/ea.
-----------------------------	--------------

1968 Fury III & Sport Fury

Hardtop - (Perforated Grain)

HL68CF3H01 (Black).....	\$198.00/ea.
-------------------------	--------------

HL68CF3H02 (White).....	\$198.00/ea.
-------------------------	--------------

HL68CF3H13 (Dark Green).....	\$198.00/ea.
------------------------------	--------------

Hardtop - OEM Style - (Fine Pembroke Grain)

HL68CF3H101 (Black).....	\$270.00/ea.
--------------------------	--------------

HL68CF3H102 (White).....	\$270.00/ea.
--------------------------	--------------

HL68CF3H107 (Dark Blue).....	\$270.00/ea.
------------------------------	--------------

HL68CF3H110 (Bright Blue).....	\$270.00/ea.
--------------------------------	--------------

HL68CF3H113 (Dark Green).....	\$270.00/ea.
-------------------------------	--------------

Fastop - (Perforated Grain)

HL68CF01F (Black).....	\$198.00/ea.
------------------------	--------------

HL68CF02F (White).....	\$198.00/ea.
------------------------	--------------

HL68CF07F (Dark Blue).....	\$198.00/ea.
----------------------------	--------------

HL68CF13F (Dark Green).....	\$198.00/ea.
-----------------------------	--------------

HL68CF18F (Light Blue).....	\$198.00/ea.
-----------------------------	--------------

HL68CF31F (Maroon).....	\$198.00/ea.
-------------------------	--------------

Fastop - OEM Style - (Fine Pembroke Grain)

HL68CF101F (Black).....	\$270.00/ea.
-------------------------	--------------

HL68CF102F (White).....	\$270.00/ea.
-------------------------	--------------

HL68CF107F (Dark Blue).....	\$270.00/ea.
-----------------------------	--------------

HL68CF110F (Bright Blue).....	\$270.00/ea.
-------------------------------	--------------

HL68CF113F (Dark Green).....	\$270.00/ea.
------------------------------	--------------



HEADLINER RETAINING CLIPS



Metal u-shaped retaining clips slide onto the edge of the roof-rail and help hold the headliner in place.

HLCLIP (Pkg/12).....\$5.00/pk.

HEADLINER BOW RETAINER CLIPS



Metal retainer clips slide onto the edge of the roof-rail and help secure headliner bows during installation of headliner.

HLRETAIN (Pkg/10)..... \$39.00/pk.

HEADLINER INSULATION

Headliner insulation kits glue directly to the roof and provide protection from noise, heat and cold infiltration.

1963-65 B-Body
HI63CFPRW\$29.00/kit

1966-67 B-Body
HI66CRW\$29.00/kit

1968-70 B-Body
HI68CRWX\$29.00/kit

1971-74 B-Body
HI71CRX\$29.00/kit

1969-72 C-Body
HI69CFMP\$49.00/kit

NOS HEADLINERS

Some colors and grains are not reproduced in today's market. We offer NOS (New Old Stock) headliners for those extremely limited items. Many years and models are available. Please call for assistance.

HLNOS \$935.00/ea.

Please specify year and model.



Chrysler, Dodge, Plymouth

SAIL PANEL BOARDS



Die-cut to original size and shape, these repro-duction sail panel boards replace warped or water damaged originals. Available covered with headliner material or plain where applicable by year and model.

NOTE: Due to a special proprietary process used in-house, we guarantee the vinyl WILL NOT bubble or delaminate from the board.

B-BODY MODELS

1965 Coronet & Coronet 500 1965 Belvedere & Satellite

SB65CRWPLAIN (Hardtop) (Plain).....\$33.00/pr.
SB65CRWPLAINS (Sedan) (Plain).....\$33.00/pr.

1966-67 Coronet & Coronet 500 1966-67 Satellite & GTX

SB66CRWPLAIN (Hardtop) (Plain).....\$33.00/pr.
SB66CRWPLAINS (Sedan) (Plain).....\$33.00/pr.
☞ 1966-67 B-Body models used a plain sail panel only.

1968 Coronet & Coronet 500

SB68CWPLAIN (Plain).....\$33.00/pr.
(Perforated Grain)
SB68CW00001 (Black).....\$66.00/pr.
SB68CW00002 (White).....\$66.00/pr.
SB68CW00007 (Dark Blue).....\$66.00/pr.
SB68CW00011 (Med Blue).....\$66.00/pr.
SB68CW00013 (Dark Green).....\$66.00/pr.
SB68CW00017 (Buckskin).....\$66.00/pr.
SB68CW00031 (Maroon).....\$66.00/pr.

OEM Style - (Fine Pembroke Grain)

SB68CW00101 (Black).....\$97.00/pr.
SB68CW00102 (White).....\$97.00/pr.
SB68CW00113 (Green).....\$97.00/pr.
☞ Will work on both Hardtop and Sedan models.

1968 Roadrunner, Satellite & GTX

SB68CRPLAIN (Plain).....\$33.00/pr.
(Perforated Grain)
SB68CR00001 (Black).....\$66.00/pr.
SB68CR00002 (White).....\$66.00/pr.
SB68CR00011 (Medium Blue).....\$66.00/pr.
SB68CR00013 (Dark Green).....\$66.00/pr.
SB68CR00017 (Buckskin).....\$66.00/pr.
SB68CR00031 (Maroon).....\$66.00/pr.

OEM Style - (Fine Pembroke Grain)

SB68CR00101 (Black).....\$97.00/pr.
SB68CR00102 (White).....\$97.00/pr.
SB68CR00113 (Dark Green).....\$97.00/pr.
☞ Will work on both Hardtop and Sedan models.

1968-70 Charger

SB68CXPLAIN (Plain).....\$33.00/pr.
☞ 1968-70 Charger models used a plain sail panel only.

1969 Coronet & Coronet 500 1969 Roadrunner, Satellite & GTX

SB69CRWPLAIN (Plain).....\$33.00/pr.
(Perforated Grain)
SB69CRW00001 (Black).....\$66.00/pr.
SB69CRW00002 (White).....\$66.00/pr.
SB69CRW00003 (Red).....\$66.00/pr.
SB69CRW00007 (Dark Blue).....\$66.00/pr.
SB69CRW00013 (Dark Green).....\$66.00/pr.
SB69CRW00017 (Buckskin).....\$66.00/pr.

OEM Style - (Fine Pembroke Grain)

SB69CRW00101 (Black).....\$97.00/pr.
SB69CRW00102 (White).....\$97.00/pr.
SB69CRW00107 (Dark Blue).....\$97.00/pr.
SB69CRW00113 (Dark Green).....\$97.00/pr.
☞ Will work on both Hardtop and Sedan models.

B-BODY MODELS CONT.

1970 Coronet & Coronet 500 1970 Roadrunner, Satellite & GTX

SB70CRWPLAIN (Plain).....\$33.00/pr.
(Perforated Grain)
SB70CRW00001 (Black).....\$66.00/pr.
SB70CRW00002 (White).....\$66.00/pr.
SB70CRW00007 (Dark Blue).....\$66.00/pr.
SB70CRW00013 (Dark Green).....\$66.00/pr.
SB70CRW00098 (Brown).....\$66.00/pr.

OEM Style - (Fine Pembroke Grain)

SB70CRW00101 (Black).....\$97.00/pr.
SB70CRW00102 (White).....\$97.00/pr.
SB70CRW00107 (Dark Blue).....\$97.00/pr.
SB70CRW00113 (Dark Green).....\$97.00/pr.
SB70CRW00122 (Burnt Orange).....\$97.00/pr.

☞ Will work on both Hardtop and Sedan models.

1971-72 Roadrunner, Satellite & GTX

SB71CRPLAIN (Plain).....\$33.00/pr.
(Perforated Grain)
SB71CR00001 (Black).....\$66.00/pr.
SB71CR00002 (White).....\$66.00/pr.
SB71CR00007 (Dark Blue).....\$66.00/pr.
SB71CR00011 (Medium Blue).....\$66.00/pr.
SB71CR00013 (Dark Green).....\$66.00/pr.
SB71CR00017 (Buckskin).....\$66.00/pr.
SB71CR00098 (Brown).....\$66.00/pr.

OEM Style - (Fine Pembroke Grain)

SB71CR000101 (Black).....\$97.00/pr.
SB71CR000102 (White).....\$97.00/pr.
SB71CR000107 (Dark Blue).....\$97.00/pr.
SB71CR000110 (Bright Blue).....\$97.00/pr.
SB71CR000113 (Dark Green).....\$97.00/pr.

1973-74 Charger

SB71CXPLAIN (Plain).....\$33.00/pr.
(Perforated Grain)
SB71CX00001 (Black).....\$66.00/pr.
SB71CX00002 (White).....\$66.00/pr.
SB71CX00038 (Sandalwood).....\$66.00/pr.
SB71CX00098 (Brown).....\$66.00/pr.

OEM Style - (Fine Pembroke Grain)

SB71CX000101 (Black).....\$97.00/pr.
SB71CX000102 (White).....\$97.00/pr.
SB71CX000107 (Dark Blue).....\$97.00/pr.
SB71CX000110 (Bright Blue).....\$97.00/pr.
SB71CX000113 (Dark Green).....\$97.00/pr.

(Non-Perforated Grain)

SB71CX0001NP (Black).....\$66.00/pr.
SB71CX0002NP (White).....\$66.00/pr.
SB71CX0007NP (Dark Blue).....\$66.00/pr.
SB71CX0011NP (Medium Blue).....\$66.00/pr.
SB71CX0013NP (Dark Green).....\$66.00/pr.
SB71CX0038NP (Sandalwood).....\$66.00/pr.

1973-74 Charger SE

SB73CXPLAIN (Plain).....\$33.00/pr.
(Non-Perforated Grain)
SB73CX0001NP (Black).....\$66.00/pr.
SB73CX0002NP (White).....\$66.00/pr.
SB73CX0007NP (Dark Blue).....\$66.00/pr.
SB73CX0011NP (Medium Blue).....\$66.00/pr.
SB73CX0013NP (Dark Green).....\$66.00/pr.
SB73CX0038NP (Sandalwood).....\$66.00/pr.

C-BODY MODELS

1965 Polara/Polara 500 & Monaco

OEM Style - (Crosshatch Grain)
SB65CP101 (Black).....\$97.00/pr.
SB65CP111 (Light Metallic Blue).....\$97.00/pr.
SB65CP121 (Metallic Red).....\$97.00/pr.





SUNVISORS

Original reproduction sunvisors are made with the correct grains and vinyl colors as applicable by year/make/model to compliment and match your Legendary interior. Superior materials and technology with World Class craftsmanship create the highest quality sunvisors available. Original mounting hardware and metal rod must be reused. Please specify hardtop or convertible and color at time of order.

- Factory correct size, shape, colors and grains by year, make and model
- Original fit and appearance
- Custom colors and grains available
- Limited Lifetime Warranty (*First and only in the industry!!!*)
- Correct multi layer construction applicable by year, make and model
- Available with or without cut-outs for driver and passenger mirror options



Correct multi layer construction & shape applicable by year, make, model & body style

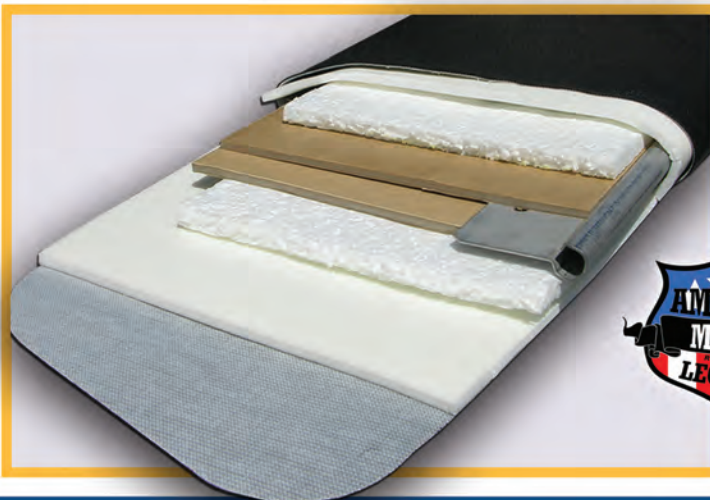

SUNVISORS

B-BODY MODELS

1963-64 Polara & Polara 500
1963-64 Belvedere, Fury & Sport Fury
Hardtop (Perforated Grain)
 SV63CFPRW01-PA (Black)..... \$168.00/pr.
 SV63CFPRW02-PA (White)..... \$168.00/pr.
Convertible (Bison Grain)
 SV63CFPRW100C-PA (Black)..... \$168.00/pr.
 SV63CFPRW206C-PA (Taupe)..... \$168.00/pr.
 SV63CFPRW302C-PA (Blue)..... \$168.00/pr.
 SV63CFPRW314C-PA (Met Blue)..... \$168.00/pr.
 SV63CFPRW406C-PA (Lt Turquoise)..... \$168.00/pr.
 SV63CFPRW410C-PA (Lt Met Olive)..... \$168.00/pr.
 SV63CFPRW416C-PA (Met Turq.)..... \$168.00/pr.
 SV63CFPRW510C-PA (Crimson Red)..... \$168.00/pr.
 SV63CFPRW606C-PA (Dk Copper)..... \$168.00/pr.
 SV63CFPRW610C-PA (Met Fawn)..... \$168.00/pr.

1965 Coronet & Coronet 500
1965 Belvedere I, Belvedere II & Satellite
Hardtop OEM Style (Crosshatch Grain)
 SV65CRW101-PA (Black)..... \$245.00/pr.
 SV65CRW102-PA (White)..... \$245.00/pr.
 SV65CRW111-PA (Light Metallic Blue)..... \$245.00/pr.
 SV65CRW121-PA (Metallic Red)..... \$245.00/pr.
Convertible (Bison Grain)
 SV65CRW100C-PA (Black)..... \$168.00/pr.
 SV65CRW314C-PA (Met Blue)..... \$168.00/pr.
 SV65CRW416C-PA (Met Turquoise)..... \$168.00/pr.
 SV65CRW520C-PA (Crimson Red)..... \$168.00/pr.
 SV65CRW610C-PA (Met Fawn)..... \$168.00/pr.

1966-67 Charger, Coronet, Satellite & GTX
Hardtop (Cologne Grain)
 SV66CRWX100-PA (Black)..... \$168.00/pr.
 SV66CRWX202-PA (Pearl White)..... \$168.00/pr.
 SV66CRWX318-PA (Lt Met Blue)..... \$168.00/pr.
 SV66CRWX320-PA (Met Navy)..... \$168.00/pr.
 SV66CRWX416-PA (Met Turquoise)..... \$168.00/pr.
 SV66CRWX420-PA (Citron)..... \$168.00/pr.
 SV66CRWX520-PA (Met Red)..... \$168.00/pr.
 SV66CRWX614-PA (Gold)..... \$168.00/pr.
 SV66CRWX618-PA (Light Gold)..... \$335.00/pr.
 SV66CRWX620-PA (Copper)..... \$168.00/pr.
Convertible (Cologne Grain)
 SV66CRW100C-PA (Black)..... \$168.00/pr.
 SV66CRW202C-PA (Pearl White)..... \$168.00/pr.
 SV66CRW318C-PA (Lt Met Blue)..... \$168.00/pr.
 SV66CRW320C-PA (Met Navy)..... \$168.00/pr.
 SV66CRW332C-PA (Lt Met Blue)..... \$168.00/pr.
 SV66CRW420C-PA (Citron)..... \$168.00/pr.
 SV66CRW520C-PA (Metallic Red)..... \$168.00/pr.
 SV66CRW526C-PA (Met Maroon)..... \$168.00/pr.
 SV66CRW614C-PA (Gold)..... \$168.00/pr.
 SV66CRW620C-PA (Copper)..... \$168.00/pr.

1968 Charger & Coronet
1968 Roadrunner, Satellite & GTX
Hardtop (Cologne Grain)
 SV67CBLVRWX100-PA (Black)..... \$168.00/pr.
 SV67CBLVRWX202-PA (Prl White)..... \$168.00/pr.
 SV67CBLVRWX332-PA (Lt Met Blue)..... \$168.00/pr.
 SV67CBLVRWX430-PA (Dk Met Green)..... \$168.00/pr.
 SV67CBLVRWX526-PA (Met Maroon)..... \$168.00/pr.
 SV67CBLVRWX634-PA (Lt Met Fawn)..... \$168.00/pr.
 SV67CBLVRWX636-PA (Ember Gold)..... \$168.00/pr.
Convertible (Cologne Grain)
 SV68CRW100C-PA (Black)..... \$168.00/pr.
 SV68CRW202C-PA (Pearl White)..... \$168.00/pr.
 SV68CRW332C-PA (Lt Met Blue)..... \$168.00/pr.
 SV68CRW430C-PA (Dk Met Green)..... \$168.00/pr.
 SV68CRW526C-PA (Met Maroon)..... \$168.00/pr.

B-BODY MODELS CONT.

1969 Charger, Coronet & Daytona
1969 Roadrunner, Satellite & GTX
Hardtop (Coachman Grain)
 SV69CBLVRWX100-PA (Black)..... \$168.00/pr.
 SV69CBLVRWX200-PA (White)..... \$168.00/pr.
 SV69CBLVRWX330-PA (Dk Met Blue)..... \$168.00/pr.
 SV69CBLVRWX434-PA (Dk Met Green)..... \$168.00/pr.
 SV69CBLVRWX528-PA (Red)..... \$168.00/pr.
 SV69CBLVRWX650-PA (Saddle)..... \$168.00/pr.
 SV69CBLVRWX670-PA ("Dukes" Tan)..... \$168.00/pr.
Convertible (Coachman Grain)
 SV69CRW100C-PA (Black)..... \$168.00/pr.
 SV69CRW200C-PA (White)..... \$168.00/pr.
 SV69CRW330C-PA (Dk Met Blue)..... \$168.00/pr.
 SV69CRW434C-PA (Dk Met Green)..... \$168.00/pr.
 SV69CRW528C-PA (Red)..... \$168.00/pr.
 SV69CRW640C-PA (Bronze)..... \$168.00/pr.
 SV69CRW650C-PA (Saddle)..... \$168.00/pr.

1970 Charger & Coronet
1970 Roadrunner, Satellite, GTX & Superbird
Hardtop (Coachman Grain)
 SV69CBLVRWX100-PA (Black)..... \$168.00/pr.
 SV69CBLVRWX200-PA (White)..... \$168.00/pr.
 SV69CBLVRWX330-PA (Dk Met Blue)..... \$168.00/pr.
 SV69CBLVRWX338-PA (Bright Blue)..... \$168.00/pr.
 SV69CBLVRWX434-PA (Dk Met Green)..... \$168.00/pr.
 SV69CBLVRWX540-PA (Brnt Orange)..... \$168.00/pr.
 SV69CBLVRWX656-PA (Brown)..... \$168.00/pr.
Convertible (Coachman Grain)
 SV70CRW100C-PA (Black)..... \$168.00/pr.
 SV70CRW200C-PA (White)..... \$168.00/pr.
 SV70CRW330C-PA (Dk Met Blue)..... \$168.00/pr.
 SV70CRW338C-PA (Bright Blue)..... \$168.00/pr.
 SV70CRW434C-PA (Dk Met Green)..... \$168.00/pr.
 SV70CRW540C-PA (Burnt Orange)..... \$168.00/pr.
 SV70CRW656C-PA (Brown)..... \$168.00/pr.

1971-73 Charger, Roadrunner, Satellite & GTX
(Coachman Grain)
 SV71CRX100-PA (Black)..... \$168.00/pr.
 SV71CRX140-PA (Gunmetal)..... \$168.00/pr.
 SV71CRX200-PA (White)..... \$168.00/pr.
 SV71CRX250-PA (Parchment)..... \$168.00/pr.
 SV71CRX340-PA (Bright Blue)..... \$168.00/pr.
 SV71CRX444-PA (Dark Green)..... \$168.00/pr.
 SV71CRX452-PA (Dark Met Green)..... \$168.00/pr.
 SV71CRX662-PA (Brown)..... \$168.00/pr.
 SV71CRX664-PA (Brown)..... \$168.00/pr.
 SV71CRX666-PA (Ember Gold)..... \$168.00/pr.
 SV71CRX672-PA (NOS Honey Gold)..... \$335.00/pr.
 ☞ 1971-73 models.

1972-73 Charger, Roadrunner, Satellite & GTX
(Coachman Grain)
 SV72CRX100-PA (Black)..... \$168.00/pr.
 SV72CRX200-PA (White)..... \$168.00/pr.
 SV72CRX250-PA (Parchment)..... \$168.00/pr.
 SV72CRX340-PA (Bright Blue)..... \$168.00/pr.
 SV72CRX444-PA (Dark Green)..... \$168.00/pr.
 SV72CRX662-PA (Brown)..... \$168.00/pr.
 SV72CRX666-PA (Ember Gold)..... \$168.00/pr.
 SV72CRX672-PA (NOS Honey Gold)..... \$335.00/pr.
 ☞ 1972-73 models only.

B-BODY MODELS CONT.

1974 Charger
1974 Roadrunner, Satellite & GTX
(Oxford Grain)
 SV74CRX100-PA (Black)..... \$168.00/pr.
 SV74CRX200-PA (White)..... \$168.00/pr.
 SV74CRX264-PA (Parchment)..... \$335.00/pr.
 SV74CRX360-PA (Lagoon Blue)..... \$168.00/pr.
 SV74CRX450-PA (Jade Green)..... \$168.00/pr.
 SV74CRX680-PA (Honey Gold)..... \$335.00/pr.

C-BODY MODELS

1963-64 Chrysler 300
Convertible - (Bison Grain)
 SV63CM100C-PA (Black)..... \$182.00/pr.
 SV63CM202C-PA (Pearl White)..... \$182.00/pr.
 SV63CM204C-PA (Dark White)..... \$182.00/pr.
 SV63CM206C-PA (Taupe)..... \$182.00/pr.
 SV63CM314C-PA (Metallic Blue)..... \$182.00/pr.
 SV63CM329C-PA (Metallic Blue)..... \$182.00/pr.
 SV63CM406C-PA (Turquoise)..... \$182.00/pr.
 SV63CM520C-PA (Metallic Red)..... \$182.00/pr.
 SV63CM530C-PA (Claret Red)..... \$182.00/pr.
 SV63CM610C-PA (Metallic Fawn)..... \$182.00/pr.

1963-64 Chrysler 300
Hardtop - (Non-Perforated Grain)
 SV63CM02-PA (White)..... \$182.00/pr.
 SV63CM04-PA (Light Aqua)..... \$182.00/pr.
 SV63CM58-PA (Powder Blue)..... \$182.00/pr.

1965-66 Chrysler 300 & Newport
1965-66 Polara & Monaco
1965-66 Fury & Sport Fury
Hardtop OEM Style (Crosshatch Grain)
 SV65CFMP101-PA (Black)..... \$245.00/pr.
 SV65CFMP102-PA (White)..... \$245.00/pr.
 SV65CFMP111-PA (Lt Met Blue)..... \$245.00/pr.
 SV65CFMP121-PA (Metallic Red)..... \$245.00/pr.

1965-66 Chrysler 300 & Newport
Convertible (Cologne Grain)
 SV65CM100C-PA (Black)..... \$182.00/pr.
 SV65CM102C-PA (Silver)..... \$182.00/pr.
 SV65CM202C-PA (Pearl White)..... \$182.00/pr.
 SV65CM320C-PA (Met Navy)..... \$182.00/pr.
 SV65CM322C-PA (Med Met Blue)..... \$182.00/pr.
 SV65CM520C-PA (Metallic Red)..... \$182.00/pr.
 SV65CM610C-PA (Metallic Fawn)..... \$182.00/pr.
 SV65CM614C-PA (Gold)..... \$182.00/pr.
 SV65CM614C-PA (Ginger)..... \$182.00/pr.

1966-68 Chrysler 300, Newport & New Yorker
1966-68 Polara & Monaco
1966-68 Fury & Sport Fury
Hardtop (Cologne Grain)
 SV66CFMP100-PA (Black)..... \$182.00/pr.
 SV66CFMP202-PA (Pearl White)..... \$182.00/pr.
 SV66CFMP318-PA (Lt Metallic Blue)..... \$182.00/pr.
 SV66CFMP320-PA (Metallic Navy)..... \$182.00/pr.
 SV66CFMP330-PA (Dark Met. Blue)..... \$182.00/pr.
 SV66CFMP332-PA (Lt Metallic Blue)..... \$182.00/pr.
 SV66CFMP420-PA (Citron)..... \$182.00/pr.
 SV66CFMP430-PA (Dark Green)..... \$182.00/pr.
 SV66CFMP520-PA (Metallic Red)..... \$182.00/pr.
 SV66CFMP614-PA (Gold)..... \$182.00/pr.
 SV66CFMP616-PA (Ginger)..... \$182.00/pr.
 SV66CFMP620-PA (Copper)..... \$182.00/pr.



SUNVISORS CONT.

C-BODY MODELS CONT.

**1969-70 Chrysler 300, Newport & New Yorker
1969-70 Polara & Monaco
1969-70 Fury & Sport Fury
Convertible (Coachman Grain)**

- SV69CFMP100C-PA (Black).....\$182.00/pr.
- SV69CFMP200C-PA (White).....\$182.00/pr.
- SV69CFMP330C-PA (Dark Blue).....\$182.00/pr.
- SV69CFMP332C-PA (Light Blue).....\$182.00/pr.
- SV69CFMP336C-PA (Navy).....\$182.00/pr.
- SV69CFMP434C-PA (Dark Green).....\$182.00/pr.
- SV69CFMP528C-PA (Red).....\$182.00/pr.
- SV69CFMP650C-PA (Saddle).....\$182.00/pr.
- SV69CFMP656C-PA (Brown).....\$182.00/pr.

**1970-71 Chrysler 300, Newport & New Yorker
1970-71 Polara & Monaco
1970-71 Fury & Sport Fury**

- Hardtop (Coachman Grain)**
- SV70CFMP100-PA (Black).....\$182.00/pr.
 - SV70CFMP200-PA (White).....\$182.00/pr.
 - SV70CFMP332-PA (Lt Met Blue).....\$182.00/pr.
 - SV70CFMP434-PA (Dk Met Green). \$182.00/pr.
 - SV70CFMP452-PA (Dk Met Green). \$182.00/pr.
 - SV70CFMP540-PA (Burnt Orange).. \$182.00/pr.
 - SV70CFMP656-PA (Brown).....\$182.00/pr.
 - SV70CFMP660-PA (Gold).....\$335.00/pr. (L1)
 - SV70CFMP664-PA (Brown).....\$182.00/pr.
 - SV70CFMP699-PA (Beige).....\$182.00/pr.

DODGE TRUCK

**1978 Lil Red Express & Warlock
(Oxford Grain)**

- SV78CDT0000100 (Black)..... \$168.00/pr.
- SV78CDT0000548 (Red)..... \$168.00/pr.

**1979 Lil Red Express & Warlock
(Oxford Grain)**

- SV79CDT0000100 (Black)..... \$168.00/pr.
- SV79CDT0000548 (Red)..... \$168.00/pr.

PLASTIC SUNVISOR TIPS



Reproduction 1962-65 Dodge & Plymouth sunvisor tips made of Delrin plastic.

SV62TIP\$29.00/pr.

RUBBER SUNVISOR TIPS



Dodge & Plymouth rubber sunvisor tips for 1966 and up models with 2-pin sunvisors and a center mounted sunvisor retainer over the rearview mirror.

SVTIP-RUBBER.....\$3.00/pr.

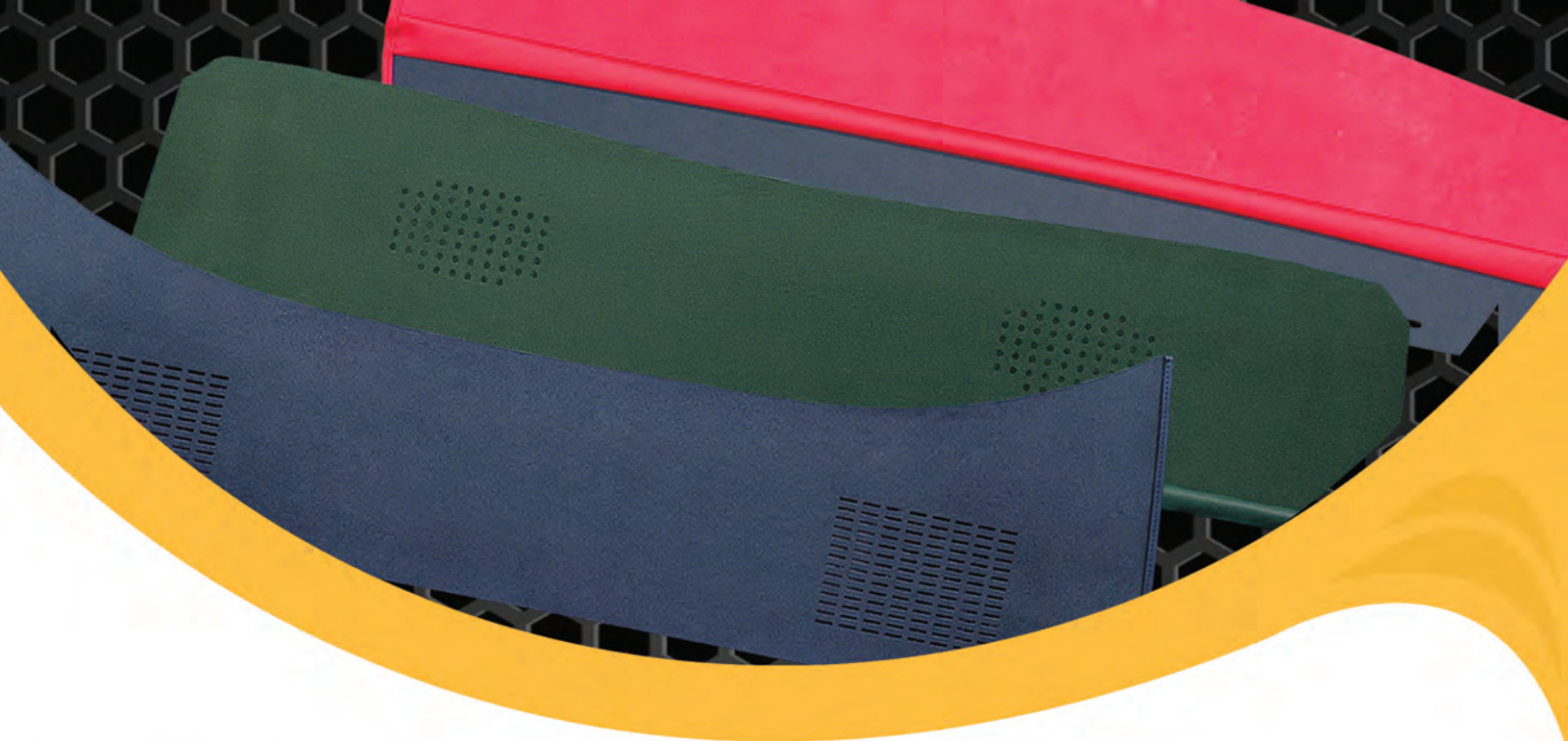





PACKAGE TRAYS AND JUTE INSULATION

Die-cut to original specifications, these reproductions of the original panels go between the top of the rear seat and the back window. Colors are year specific and are available with or without speaker grill cutouts. Die-cut jute insulation helps reduce the amount of noise and heat that would come from the trunk compartment.



PACKAGE TRAY AND TRUNK ACCESORIES

 facebook.com/legendaryautointeriors
 twitter.com/legendaryautoin

 www.legendaryautointeriors.com
 instagram.com/legendaryautointeriorsltd
 youtube.com/user/legendaryauto

PACKAGE TRAYS & JUTE INSULATION

B-BODY MODELS

1962 Fury & Sport Fury

Hardtop w/o Cuts

PT62CF100N (Black)	\$79.00/ea.
PT62CF206N (Taupe)	\$79.00/ea.
PT62CF302N (Blue)	\$79.00/ea.
PT62CF406N (Light Turquoise)	\$79.00/ea.
PT62CF510N (Crimson Red)	\$79.00/ea.
PT62CFJ (jute insulation)	\$27.00/ea.

1963 Dodge 330 & 440

Sedan w/o Cuts

PT63CPD330314N (Metallic Blue)	\$79.00/ea.
PT63CPD330410N (Light Met. Olive)	\$79.00/ea.
PT63CPD330416N (Met. Turquoise)	\$79.00/ea.
PT63CPD330510N (Crimson Red)	\$79.00/ea.
PT63CPD330610N (Metallic Fawn)	\$79.00/ea.

Sedan w/ Cuts

PT63CPD330314 (Metallic Blue)	\$119.00/ea.
PT63CPD330410 (Light Met. Olive)	\$119.00/ea.
PT63CPD330416 (Met. Turquoise)	\$119.00/ea.
PT63CPD330510 (Crimson Red)	\$119.00/ea.
PT63CPD330610 (Metallic Fawn)	\$119.00/ea.
PT63CPD330J (jute insulation)	\$27.00/ea.

1963 Dodge 440, Polara & Polara 500 1963 Belvedere, Fury & Sport Fury

Hardtop w/o Cuts

PT63CF100N (Black)	\$79.00/ea.
PT63CF206N (Taupe)	\$79.00/ea.
PT63CF302N (Blue)	\$79.00/ea.
PT63CF406N (Light Turquoise)	\$79.00/ea.
PT63CF510N (Crimson Red)	\$79.00/ea.

Hardtop w/ Cuts

PT63CF100 (Black)	\$119.00/ea.
PT63CF206 (Taupe)	\$119.00/ea.
PT63CF302 (Blue)	\$119.00/ea.
PT63CF406 (Light Turquoise)	\$119.00/ea.
PT63CF510 (Crimson Red)	\$119.00/ea.
PT63CFJ (jute insulation)	\$27.00/ea.

B-BODY MODELS CONT.

1964 Dodge 440, Polara & Polara 500

1964 Belvedere, Fury & Sport Fury

1965 Coronet & Coronet 500

1965 Belvedere II & Satellite

Hardtop w/o Cuts

PT64CRW100N (Black)	\$79.00/ea.
PT64CRW314N (Metallic Blue)	\$79.00/ea.
PT64CRW410N (Light Met. Olive)	\$79.00/ea.
PT64CRW416N (Met. Turquoise)	\$79.00/ea.
PT64CRW510N (Crimson Red)	\$79.00/ea.
PT64CRW520N (Metallic Red)	\$79.00/ea.
PT64CRW606N (Dark Copper)	\$79.00/ea.
PT64CRW610N (Metallic Fawn)	\$79.00/ea.
PT64CRW614N (Gold)	\$79.00/ea.

Hardtop w/ Cuts

PT64CRW100 (Black)	\$119.00/ea.
PT64CRW314 (Metallic Blue)	\$119.00/ea.
PT64CRW410 (Light Met. Olive)	\$119.00/ea.
PT64CRW416 (Met. Turquoise)	\$119.00/ea.
PT64CRW510 (Crimson Red)	\$119.00/ea.
PT64CRW520 (Metallic Red)	\$119.00/ea.
PT64CRW606 (Dark Copper)	\$119.00/ea.
PT64CRW610 (Metallic Fawn)	\$119.00/ea.
PT64CRW614 (Gold)	\$119.00/ea.

Hardtop w/ Center Cut

PT64CRW100C (Black)	\$119.00/ea.
PT64CRW314C (Metallic Blue)	\$119.00/ea.
PT64CRW410C (Light Met. Olive)	\$119.00/ea.
PT64CRW416C (Met. Turquoise)	\$119.00/ea.
PT64CRW510C (Crimson Red)	\$119.00/ea.
PT64CRW520C (Metallic Red)	\$119.00/ea.
PT64CRW606C (Dark Copper)	\$119.00/ea.
PT64CRW610C (Metallic Fawn)	\$119.00/ea.
PT64CRW614C (Gold)	\$119.00/ea.
PT64CRWJ (jute insulation)	\$27.00/ea.

1964 Polara, Fury

4 Door w/o Cuts

PT64CFPRW314N (Metallic Blue)	\$79.00/ea.
PT64CFPRW510N (Crimson Red)	\$79.00/ea.
PT64CFPRW610N (Metallic Fawn)	\$79.00/ea.
PT64CFPRWJ (jute insulation)	\$27.00/ea.

 Fits 4-door hardtop & 4-door sedan models.

1964 Savoy & Belvedere

Sedan w/o Cuts

PT64CS314N (Metallic Blue)	\$79.00/ea.
PT64CS510N (Crimson Red)	\$79.00/ea.
PT64CS610N (Metallic Fawn)	\$79.00/ea.
PT64CSJ (jute insulation)	\$27.00/ea.

B-BODY MODELS CONT.

1964-65 Coronet

1965 Belvedere I

2 & 4 Door Sedan w/o Cuts

PT64CFPRW314N (Metallic Blue)	\$79.00/ea.
PT64CFPRW510N (Crimson Red)	\$79.00/ea.
PT64CFPRW610N (Metallic Fawn)	\$79.00/ea.
PT64CFPRWJ (jute insulation)	\$27.00/ea.

 Fits 1964-65 Coronet 2 & 4-door sedan models.

 Fits 1965 Belvedere I 2 & 4-door sedan models.

1966-67 Coronet & Coronet 500

1966-67 Belvedere II, Satellite & GTX

Hardtop w/o Cuts

PT66CRW100N (Black)	\$79.00/ea.
PT66CRW318N (Light Metallic Blue)	\$79.00/ea.
PT66CRW320N (Metallic Navy)	\$79.00/ea.
PT66CRW416N (Met. Turquoise)	\$79.00/ea.
PT66CRW420N (Citron)	\$79.00/ea.
PT66CRW520N (Metallic Red)	\$79.00/ea.
PT66CRW614N (Gold)	\$79.00/ea.
PT66CRW618N (Light Gold)	\$79.00/ea.
PT66CRW620N (Copper)	\$79.00/ea.

Hardtop w/ Cuts

PT66CRW100 (Black)	\$119.00/ea.
PT66CRW318 (Light Metallic Blue)	\$119.00/ea.
PT66CRW320 (Metallic Navy)	\$119.00/ea.
PT66CRW416 (Met. Turquoise)	\$119.00/ea.
PT66CRW420 (Citron)	\$119.00/ea.
PT66CRW520 (Metallic Red)	\$119.00/ea.
PT66CRW614 (Gold)	\$119.00/ea.
PT66CRW618 (Light Gold)	\$119.00/ea.
PT66CRW620 (Copper)	\$119.00/ea.
PT66CRWJ (jute insulation)	\$27.00/ea.

1966-67 Belvedere I

2 & 4 Door w/o Cuts

PT66CR4D318N (Light Metallic Blue)	\$79.00/ea.
PT66CR4D320N (Metallic Navy)	\$79.00/ea.
PT66CR4D520N (Metallic Red)	\$79.00/ea.
PT66CR4D618N (Light Gold)	\$79.00/ea.
PT66CR4DJ (jute insulation)	\$27.00/ea.

1968 Belvedere & Satellite

4 Door Hardtop w/ Cuts

PT68CR4D(C)N (4dr. HTP w/o cuts)	\$79.00/ea.
PT68CR4D(C)O (4dr. HTP w/ opp cuts)	\$119.00/ea.
PT68CR4DJ (jute insulation)	\$27.00/ea.

 Please specify color package tray at time of order.

1968-70 Coronet, Roadrunner,

Satellite & GTX

Hardtop w/o Cuts

PT68CRW100N (Black)	\$79.00/ea.
PT68CRW330N (Dark Metallic Blue)	\$79.00/ea.
PT68CRW332N (Light Metallic Blue)	\$79.00/ea.
PT68CRW338N (Brite Blue)	\$79.00/ea.
PT68CRW430N (Dark Met. Green)	\$79.00/ea.
PT68CRW434N (Dark Met. Green)	\$79.00/ea.
PT68CRW520N (Metallic Red)	\$79.00/ea.
PT68CRW526N (Metallic Maroon)	\$79.00/ea.
PT68CRW528N (Red)	\$79.00/ea.
PT68CRW540N (Burnt Orange)	\$79.00/ea.
PT68CRW634N (Light Metallic Fawn)	\$79.00/ea.
PT68CRW638N (Dark Gold)	\$79.00/ea.
PT68CRW640N (Bronze)	\$79.00/ea.
PT68CRW650N (Saddle)	\$79.00/ea.
PT68CRW656N (Brown)	\$79.00/ea.



PACKAGE TRAYS & JUTE INSULATION CONT.

B-BODY MODELS CONT.

1968-70 Coronet, Roadrunner, Satellite & GTX 
Hardtop w/ Same Cuts

PT68CRW100S (Black)	\$119.00/ea.
PT68CRW330S (Dark Metallic Blue)	\$119.00/ea.
PT68CRW332S (Light Metallic Blue)	\$119.00/ea.
PT68CRW338S (Bright Blue)	\$119.00/ea.
PT68CRW430S (Dark Metallic Green)	\$119.00/ea.
PT68CRW434S (Dark Metallic Green)	\$119.00/ea.
PT68CRW520S (Metallic Red)	\$119.00/ea.
PT68CRW526S (Metallic Maroon)	\$119.00/ea.
PT68CRW528S (Red)	\$119.00/ea.
PT68CRW540S (Burnt Orange)	\$119.00/ea.
PT68CRW634S (Light Metallic Fawn)	\$119.00/ea.
PT68CRW638S (Dark Gold)	\$119.00/ea.
PT68CRW640S (Bronze)	\$119.00/ea.
PT68CRW650S (Saddle)	\$119.00/ea.
PT68CRW656S (Brown)	\$119.00/ea.

Hardtop w/ Opposite Cuts

PT68CRW100O (Black)	\$119.00/ea.
PT68CRW330O (Dark Metallic Blue)	\$119.00/ea.
PT68CRW332O (Light Metallic Blue)	\$119.00/ea.
PT68CRW338O (Bright Blue)	\$119.00/ea.
PT68CRW430O (Dark Metallic Green)	\$119.00/ea.
PT68CRW434O (Dark Metallic Green)	\$119.00/ea.
PT68CRW520O (Metallic Red)	\$119.00/ea.
PT68CRW526O (Metallic Maroon)	\$119.00/ea.
PT68CRW528O (Red)	\$119.00/ea.
PT68CRW540O (Burnt Orange)	\$119.00/ea.
PT68CRW634O (Light Metallic Fawn)	\$119.00/ea.
PT68CRW638O (Dark Gold)	\$119.00/ea.
PT68CRW640O (Bronze)	\$119.00/ea.
PT68CRW650O (Saddle)	\$119.00/ea.
PT68CRW656O (Brown)	\$119.00/ea.
PT68CRWJ (jute insulation)	\$27.00/ea.

1968-70 Charger 
Hardtop w/o Cuts

PT68CX100N (Black)	\$79.00/ea.
PT68CX330N (Dark Metallic Blue)	\$79.00/ea.
PT68CX338N (Bright Blue)	\$79.00/ea.
PT68CX430N (Dark Metallic Green)	\$79.00/ea.
PT68CX434N (Dark Metallic Green)	\$79.00/ea.
PT68CX520N (Metallic Red)	\$79.00/ea.
PT68CX528N (Red)	\$79.00/ea.
PT68CX540N (Burnt Orange)	\$79.00/ea.
PT68CX636N (Ember Gold)	\$79.00/ea.
PT68CX650N (Saddle)	\$79.00/ea.
PT68CX656N (Brown)	\$79.00/ea.
PT68CX670N (Tan)	\$79.00/ea.

Hardtop w/ Cuts

PT68CX100 (Black)	\$119.00/ea.
PT68CX330 (Dark Metallic Blue)	\$119.00/ea.
PT68CX338 (Bright Blue)	\$119.00/ea.
PT68CX430 (Dark Metallic Green)	\$119.00/ea.
PT68CX434 (Dark Metallic Green)	\$119.00/ea.
PT68CX520 (Metallic Red)	\$119.00/ea.
PT68CX528 (Red)	\$119.00/ea.
PT68CX540 (Burnt Orange)	\$119.00/ea.
PT68CX636 (Ember Gold)	\$119.00/ea.
PT68CX650 (Saddle)	\$119.00/ea.
PT68CX656 (Brown)	\$119.00/ea.
PT68CX670 (Tan)	\$119.00/ea.
PT68CXJ (jute insulation)	\$27.00/ea.

1970 Superbird 
Hardtop w/o Cuts

PT70CR01N (Black)	\$136.00/ea.
-------------------	--------------

B-BODY MODELS CONT.

1969 Charger 500 & Daytona 
Hardtop w/o Cuts

PT69CXD100N (Black)	\$159.00/ea.
PT69CXD330N (Dark Metallic Blue)	\$159.00/ea.
PT69CXD434N (Dark Met. Green)	\$159.00/ea.
PT69CXD528N (Red)	\$159.00/ea.
PT69CXD650N (Saddle)	\$159.00/ea.

Hardtop w/ Cuts

PT69CXD100 (Black)	\$159.00/ea.
PT69CXD330 (Dark Metallic Blue)	\$159.00/ea.
PT69CXD434 (Dark Metallic Green)	\$159.00/ea.
PT69CXD528 (Red)	\$159.00/ea.
PT69CXD650 (Saddle)	\$159.00/ea.

Customer must make cut for models with rear defrost.

1971-74 Charger, Roadrunner, Satellite & GTX 
Hardtop w/o Cuts

PT71CRX100N (Black)	\$79.00/ea.
PT71CRX340N (Bright Blue)	\$79.00/ea.
PT71CRX360N (Lagoon Blue)	\$79.00/ea.
PT71CRX444N (Dark Green)	\$79.00/ea.
PT71CRX450N (Jade Green)	\$79.00/ea.
PT71CRX452N (Dark Met. Green)	\$79.00/ea.
PT71CRX662N (Brown)	\$79.00/ea.
PT71CRX664N (Brown)	\$79.00/ea.
PT71CRX666N (Ember Gold)	\$79.00/ea.
PT71CRX680N (NOS Ember Gold)	\$79.00/ea.

Hardtop w/ Cuts

PT71CRX100 (Black)	\$119.00/ea.
PT71CRX340 (Bright Blue)	\$119.00/ea.
PT71CRX360 (Lagoon Blue)	\$119.00/ea.
PT71CRX444 (Dark Green)	\$119.00/ea.
PT71CRX450 (Jade Green)	\$119.00/ea.
PT71CRX452 (Dark Met. Green)	\$119.00/ea.
PT71CRX662 (Brown)	\$119.00/ea.
PT71CRX664 (Brown)	\$119.00/ea.
PT71CRX666 (Ember Gold)	\$119.00/ea.
PT71CRX680 (NOS Ember Gold)	\$119.00/ea.
PT71CRXJ (jute insulation)	\$27.00/ea.

C-BODY MODELS

On All C-Body Models, please specify color package tray at time of order.

1962 Newport 
Hardtop w/o Cuts

PT62CM(C)N	\$79.00/ea.
PT62CMJ (jute insulation)	\$27.00/ea.

1965 Fury I & Fury II 
Sedan w/o Cuts

PT65CF(C)N	\$79.00/ea.
PT65CF1J (jute insulation)	\$27.00/ea.

1965-66 Polara & Fury 
Hardtop w/ Cuts

PT65CFP(C)N (Hardtop w/o cuts)	\$79.00/ea.
PT65CFP(C)W (Hardtop w/ cuts)	\$119.00/ea.
PT65CFPJ (jute insulation)	\$27.00/ea.

1967-68 Fury III 
PT67CF(C)N (Hardtop w/o cuts).....\$79.00/ea.
PT67CF(C)W (Hardtop w/ cuts).....\$119.00/ea.
PT67CFJ (jute insulation).....\$27.00/ea.

1968 Fury III 
PT68CF2D(C)W (Fastop w/ cuts).....\$119.00/ea.
PT68CF2DJ (jute insulation).....\$27.00/ea.

1971 Sport Fury 
PT71CF00(C)N (Hardtop w/o cuts).....\$79.00/ea.
PT71CF00(C)W (HTP w/ dfst & cuts)..\$119.00/ea.
PT71CF00(C)WN (HTP no dfst w/ cuts)..\$119.00/ea.
PT71CFJ (jute insulation).....\$27.00/ea.



TRUNK MATS

Original style rubber trunk mats die-cut to factory specifications to assure a correct fit. Please specify material pattern at time of order.



Houndstooth

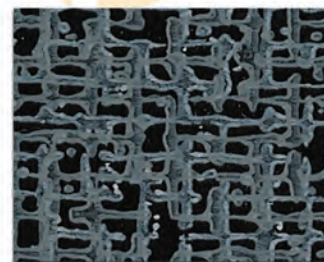

Herringbone

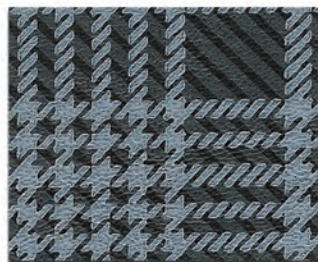

Gray Plaid

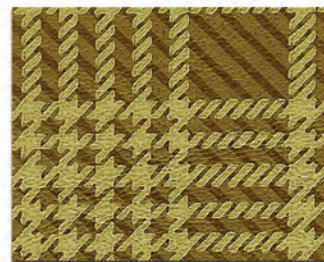

Tan Plaid

TRUNK MATS

B-BODY MODELS

1962 Fury & Sport Fury
 TM62CFGP (Hardtop) \$89.00/ea.
 TM62CFHT (Hardtop) \$89.00/ea.
 TM62CFTP (Hardtop) \$89.00/ea.

1962 Polara & Polara 500
1962-64 Dodge 440
 TM62CWGP (Hardtop) \$89.00/ea.
 TM62CWHT (Hardtop) \$89.00/ea.
 TM62CWTP (Hardtop) \$89.00/ea.

1963 Polara & Polara 500
 TM63CPGP (Hardtop) \$89.00/ea.
 TM63CPHT (Hardtop) \$89.00/ea.
 TM63CPTP (Hardtop) \$89.00/ea.
 TM63CPGPC (Convertible) \$89.00/ea.
 TM63CPHTC (Convertible) \$89.00/ea.
 TM63CPTPC (Convertible) \$89.00/ea.

1963 Belvedere, Fury & Sport Fury
 TM63CFRGP (Hardtop) \$89.00/ea.
 TM63CFRHT (Hardtop) \$89.00/ea.
 TM63CFRTP (Hardtop) \$89.00/ea.
 TM63CFGPC (Convertible) \$89.00/ea.
 TM63CFHTC (Convertible) \$89.00/ea.
 TM63CFTPC (Convertible) \$89.00/ea.
 ☞ Convertible trunk mat not for Belvedere models.

1964 Polara & Polara 500
 TM64CPGP (Hardtop) \$89.00/ea.
 TM64CPHT (Hardtop) \$89.00/ea.
 TM64CPTP (Hardtop) \$89.00/ea.
 TM64CPGPC (Convertible) \$89.00/ea.
 TM64CPHTC (Convertible) \$89.00/ea.
 TM64CPTPC (Convertible) \$89.00/ea.

1964 Fury & Sport Fury
 TM64CFGP (Hardtop) \$89.00/ea.
 TM64CFHT (Hardtop) \$89.00/ea.
 TM64CFTP (Hardtop) \$89.00/ea.
 TM64CFGPC (Convertible) \$89.00/ea.
 TM64CFHTC (Convertible) \$89.00/ea.
 TM64CFTPC (Convertible) \$89.00/ea.

1964-65 Belvedere & Satellite
 TM64CRGP (Hardtop) \$89.00/ea.
 TM64CRHT (Hardtop) \$89.00/ea.
 TM64CRTP (Hardtop) \$89.00/ea.
 TM64CRGPC (Convertible) \$89.00/ea.
 TM64CRHTC (Convertible) \$89.00/ea.
 TM64CRTPC (Convertible) \$89.00/ea.
 ☞ Convertible trunk mat not for Belvedere models.

1965 Coronet
 TM65CWGP (Hardtop) \$89.00/ea.
 TM65CWHT (Hardtop) \$89.00/ea.
 TM65CWTP (Hardtop) \$89.00/ea.
 TM65CWGPC (Convertible) \$89.00/ea.
 TM65CWHTC (Convertible) \$89.00/ea.
 TM65CWTPC (Convertible) \$89.00/ea.

1966-67 Coronet & Coronet 500
1966-67 Satellite & GTX
 TM66CRWGP (Hardtop) \$89.00/ea.
 TM66CRWHT (Hardtop) \$89.00/ea.
 TM66CRWTP (Hardtop) \$89.00/ea.
 TM66CWGPC (Coronet Convertible) \$89.00/ea.
 TM66CWHTC (Coronet Convertible) \$89.00/ea.
 TM66CWTPC (Coronet Convertible) \$89.00/ea.
 TM66CRGPC (Satellite Convertible) \$89.00/ea.
 TM66CRHTC (Satellite Convertible) \$89.00/ea.
 TM66CRTPC (Satellite Convertible) \$89.00/ea.

1966-67 Charger
 TM66CXGP (Fastback) \$89.00/ea.
 TM66CXHT (Fastback) \$89.00/ea.
 TM66CXTP (Fastback) \$89.00/ea.

B-BODY MODELS CONT.

1968-69 Coronet & Coronet 500
 TM68CWGP (Hardtop) \$89.00/ea.
 TM68CWHT (Hardtop) \$89.00/ea.
 TM68CWTP (Hardtop) \$89.00/ea.
 TM68CWGPC (Convertible) \$89.00/ea.
 TM68CWHTC (Convertible) \$89.00/ea.
 TM68CWTPC (Convertible) \$89.00/ea.

1968-69 Roadrunner, Satellite & GTX
 TM68CRGP (Hardtop) \$89.00/ea.
 TM68CRHT (Hardtop) \$89.00/ea.
 TM68CRTP (Hardtop) \$89.00/ea.
 TM68CRGPC (Convertible) \$89.00/ea.
 TM68CRHTC (Convertible) \$89.00/ea.
 TM68CRTPC (Convertible) \$89.00/ea.

1968-70 Charger, 1969 Daytona
1969-70 Charger 500
 TM68CXGP (Hardtop) \$89.00/ea.
 TM68CXHT (Hardtop) \$89.00/ea.
 TM68CXTP (Hardtop) \$89.00/ea.
 ☞ 1970 models used Herringbone only.

1970 Coronet & Coronet 500
 TM70CWHB (Hardtop) \$89.00/ea.
 TM70CWHBC (Convertible) \$89.00/ea.
 ☞ 1970 models used Herringbone only.

1970 Roadrunner, Satellite GTX & Superbird
 TM70CRHB (Hardtop) \$89.00/ea.
 TM70CRHBC (Convertible) \$89.00/ea.
 ☞ 1970 models used Herringbone only.

1971-74 Charger
1971-74 Roadrunner, Satellite & GTX
 TM71CRWXHB (Hardtop) \$89.00/ea.
 ☞ 1971-74 models used Herringbone only.

C-BODY MODELS

1965-66 Fury I, II, III & Sport Fury
 TM65CFGP (Sedan & Hardtop) \$89.00/ea.
 TM65CFHT (Sedan & Hardtop) \$89.00/ea.

1965 Fury III & Sport Fury
 TM65CFGPC (Convertible) \$89.00/ea.
 TM65CFHTC (Convertible) \$89.00/ea.

1966 Fury III & Sport Fury
 TM66CF(C)C (Convertible) \$89.00/ea.

1967 Fury III & Sport Fury
 TM67CFGP (Hardtop) \$89.00/ea.
 TM67CFHT (Hardtop) \$89.00/ea.
 TM67CFTP (Hardtop) \$89.00/ea.
 TM67CFGPC (Convertible) \$89.00/ea.
 TM67CFHTC (Convertible) \$89.00/ea.
 TM67CFTPC (Convertible) \$89.00/ea.

1967 Polara & Monaco
 TM67CPGP (Hardtop) \$89.00/ea.
 TM67CPHT (Hardtop) \$89.00/ea.
 TM67CPGPC (Convertible) \$89.00/ea.
 TM67CPHTC (Convertible) \$89.00/ea.

C-BODY MODELS CONT.

1968 Chrysler 300, Newport & New Yorker
1968 Polara & Monaco
1968 Fury III & Sport Fury
 TM68CFMPGP (Hardtop) \$89.00/ea.
 TM68CFMPHT (Hardtop) \$89.00/ea.
 TM68CFGPC (Convertible) \$89.00/ea.
 TM68CFHTC (Convertible) \$89.00/ea.
 ☞ Conv. trunk mat not for 1968 Polara & Monaco models.

1969 Fury III & Sport Fury
 TM69CF4GP (Hardtop) \$89.00/ea.
 TM69CF4GPC (Convertible) \$89.00/ea.

1969-70 Chrysler 300
 TM69CMGP (Hardtop) \$89.00/ea.
 TM69CMHB (Hardtop) \$89.00/ea.
 TM69CMHT (Hardtop) \$89.00/ea.
 TM69CMGPC (Convertible) \$89.00/ea.
 TM69CMHBC (Convertible) \$89.00/ea.

1970 Fury III & Sport Fury
 TM70CFHB (Hardtop) \$89.00/ea.
 TM70CFHBC (Convertible) \$89.00/ea.

1963-65 PLYMOUTH BELVEDERE MOLDED TRUNK MATS

Pre-molded trunk mats for 1963-65 Belvedere models. Available in Gray Plaid or Houndstooth.

TM63CRGPM \$109.00/ea.
 TM63CRHTM \$109.00/ea.

SPARE TIRE COVER



Add the finishing touch to your trunk with a spare tire cover to match your trunk mat. Made from the same trunk mat material, these covers will fit any vehicle with a floor mounted spare tire. Please specify material pattern at time of order.

ST14-15GP (Gray Plaid) \$59.00/ea.
 ST14-15HT (Houndstooth) \$59.00/ea.
 ST14-15HB (Herringbone) \$59.00/ea.
 ST14-15TP (Tan Plaid) \$59.00/ea.
 ☞ 1970 and later A, B & E-Body models used Herringbone.

TRUNK MAT MATERIAL

Legendary Auto Interiors offers an uncut roll of trunk mat material in Houndstooth, Gray or Tan Plaid and Herringbone for models not offered. You cut to size this 52" x 80" roll.

TMROLLHT (Houndstooth) \$89.00/ea.
 TMROLLGP (Gray Plaid) (shown) \$89.00/ea.
 TMROLLTP (Tan Plaid) \$89.00/ea.
 TMROLLHB (Herringbone) \$89.00/ea.



Chrysler, Dodge, Plymouth

TRUNK DIVIDERS & JUTE INSULATION

Die-cut reproduction of the black fiberboard panel that separates the rear seat from the trunk compartment.
Die-cut jute Insulation helps reduce the amount of noise and heat from the trunk compartment.

B-BODY MODELS

C-BODY MODELS

1963 Chrysler B-Body

TD63CFPRW  \$39.00/ea.
TD63CFPRWJ (jute insulation) \$37.00/ea.

1964-65 Chrysler B-Body

TD64CFPRW  \$39.00/ea.
TD64CFPRWJ (jute insulation) \$37.00/ea.

1965 Coronet & Coronet 500

1965 Belvedere & Satellite
TD63CFPRW  \$39.00/ea.
TD63CFPRWJ (jute insulation) \$37.00/ea.

1966-67 Coronet & Coronet 500

1966-67 Satellite & GTX
TD66CRW (shown)  \$35.00/ea.
TD66CRWJ (jute insulation) \$23.00/ea.

1968-70 Coronet & Charger

1969 Daytona
1968-70 Roadrunner, Satellite & GTX
1970 Superbird
TD68CRWX  \$35.00/ea.
TD68CRWXJ (jute insulation) \$23.00/ea.

1971-74 Charger

1971-74 Roadrunner, Satellite & GTX
TD71CRWX  \$35.00/ea.
TD71CRWXJ (jute insulation) \$32.00/ea.

1963 Chrysler 300

TD63CM  \$43.00/ea.

1965 Polara

1965 Fury III & Sport Fury
TD65CFP  \$39.00/ea.
TD65CFPJ (jute insulation) \$32.00/ea.

1965 Fury I & Fury II

TD65CF (Sedan)  \$43.00/ea.
TD65CFPJ (jute insulation) \$32.00/ea.

1967 Fury III & Sport Fury

TD67CF  \$56.00/ea.
TD67CFJ (jute insulation) \$32.00/ea.



TRUNK SIDE PANEL COVERS

Die-cut reproduction side panels made of black fiberboard dress-up the trunk compartment by concealing the inner quarter panels.



1963 Polara  \$129.00/kit
TP63CP (Hardtop - 4 pc.) \$129.00/kit
TP63CPC (Convertible - 4 pc.) \$129.00/kit

1963 Fury & Sport Fury  \$129.00/kit
TP63CF (Hardtop - 4 pc.) \$129.00/kit
TP63CFC (Convertible - 4 pc.) \$129.00/kit

1966-67 Charger  \$69.00/kit
TP66CX (Fastback - 5 pc.) \$69.00/kit

1971-74 Satellite, Roadrunner & GTX  \$159.00/kit
TP71CR \$159.00/kit
⚡ Kit includes trunk mat and spare tire cover.

1971-74 Charger SE  \$159.00/kit
TP71CX \$159.00/kit
⚡ Kit includes trunk mat and spare tire cover.

1973-74 Duster (w/ fold-down rear)  \$79.00/kit
TP73CV (Fastback - 3 pc.) (shown) \$79.00/kit

TRUNK FLOOR FILLER BOARDS

Die-cut reproduction trunk boards fill in the area between the trunk floor outer edges and inner quarter panels.



1962 Dodge B-Body (all models)
TB62CLP (Htp/Conv. - 2 pc.) \$29.00/kit

1963-64 Dodge B-Body (all models)
TB63CP (Htp/Conv. - 2 pc.) \$29.00/kit

1963-64 Fury & Sport Fury
TB63CF (Htp/Conv. - 2 pc.) \$49.00/kit

1963-65 Belvedere & Satellite
TB63CR (Htp/Conv. - 2 pc.) \$49.00/kit

1964 Dodge B-Body (all models)
TB64CPW (Htp/Conv. - 2 pc.) \$29.00/kit

1965 Dodge B-Body (all models)
TB65CW (Htp/Conv. - 2 pc.) \$29.00/kit

SPARE TIRE BOARD



Die-cut fiberboard panel for 1966-67 B-Body models fits over the spare tire well located under the trunk mat.

1966-67 Coronet & Charger
1966-67 Belvedere, Satellite & GTX  \$25.00/ea.
ST66CRWX (shown) \$25.00/ea.





VINYL TOPS CONVERTIBLE TOPS AND ACCESORIES

 facebook.com/legendaryautointeriors

 twitter.com/legendaryautoin

 www.legendaryautointeriors.com

 instagram.com/legendaryautointeriorsltd

 youtube.com/user/legendaryauto



VINYL TOPS

Legendary Auto Interiors, Ltd. "fitted" vinyl tops are manufactured to original specifications with the correct 100% cotton drill backing that gives trouble free installation and long term durability. All seams are double stitched and die-electrically heat-sealed insuring accurate deck width and seam durability. Each top is individually cut and fit for each specific year, make and model to give that perfect Legendary fit. Every Legendary vinyl top carries a (5) year factory warranty, the best in the industry!!

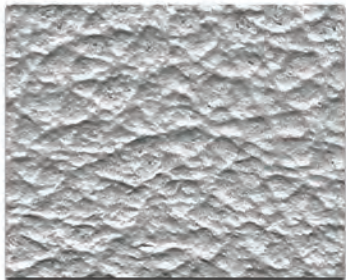

Levant Grain
(1966-67)

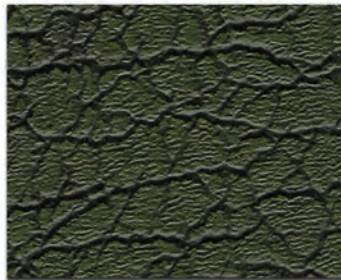

Boar Grain
(1967-74)



Cobra Grain
(1973-74)



Gator Grain
(1969-70)

GATOR GRAIN

Gator Grain vinyl tops were first available after mid-year 1969 as a custom group package option for Dodge and Plymouth C-Body models only. In 1970 Dodge and Plymouth broadened the optional Gator Grain vinyl top availability to its B and E-Body lines. These rare and highly valued vehicles are properly designated with the V1G vinyl top trim code found on the car's fender tag. Like all other Legendary Auto Interiors, Ltd. products, we have gone to great lengths accurately reproducing this most sought after material in the Mopar world. Gator grain tops are the correct "Antiqued" brown color with slight green tinting and have 1200 hours of level 5 UV (Ultra Violet) light protection with a heavy-weight cloth backing.



ORIGINAL REPRODUCTION BOAR GRAIN



01 - Black



02 - White

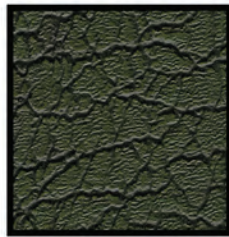

03 - Antique Green

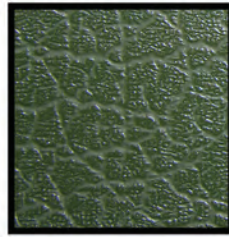

13 - Green



22 - Pearl White

AS-ORIGINAL WIDE SEAM VINYL TOPS

Exclusively for 1970-72 Challenger only



B-BODY MODELS

1966-67 Coronet & Coronet 500

1966-67 Belvedere I & II, Satellite & GTX

VTL14R01L (Levant) (41" center deck width w/ pillar post).....	\$379.00/ea.
VTL14R02L (Levant) (41" center deck width w/ pillar post).....	\$379.00/ea.
VTL14R01 (Boar) (41" center deck width w/ pillar post).....	\$379.00/ea.
VTL14R02 (Boar) (41" center deck width w/ pillar post).....	\$379.00/ea.

☞ 1966-67 models used Levant grain vinyl tops although some late production 1967 models can be found with Boar grain vinyl tops.

1966-67 Charger

VTL6X01L (Levant) (Fastback w/ 42 1/2" center deck width).....	\$379.00/ea.
VTL6X02L (Levant) (Fastback w/ 42 1/2" center deck width).....	\$379.00/ea.
VTL6X01 (Boar) (Fastback w/ 42 1/2" center deck width).....	\$379.00/ea.
VTL6X02 (Boar) (Fastback w/ 42 1/2" center deck width).....	\$379.00/ea.

1968-69 Coronet & Coronet 500

1968-69 Belvedere, Roadrunner, Satellite & GTX

VTL3RW01 (42 1/2" center deck width w/ pillar post).....	\$379.00/ea.
VTL3RW02 (42 1/2" center deck width w/ pillar post).....	\$379.00/ea.
VTL3RW03 (42 1/2" center deck width w/ pillar post).....	\$379.00/ea.
VTL3RW22 (42 1/2" center deck width w/ pillar post).....	\$379.00/ea.

☞ White was not available in 1968-69 models but may be purchased as a special order.

1968-70 Charger

VTL5X01 (37 1/2" center deck width with pillar post).....	\$379.00/ea.
VTL5X02 (37 1/2" center deck width with pillar post).....	\$379.00/ea.
VTL5X03 (37 1/2" center deck width with pillar post).....	\$379.00/ea.
VTL5X22 (37 1/2" center deck width with pillar post).....	\$379.00/ea.

VTL5X151 (Gator Grain 37 1/2" center deck width w/ pillar post) . \$1295.00/ea. (L1)
☞ White was not available in 1968-69 models but may be purchased as a special order.

1969-70 Charger (with factory sunroof)

VTL5XSUN01 (41" center deck width with pillar post).....	\$439.00/ea.
VTL5XSUN02 (41" center deck width with pillar post).....	\$439.00/ea.
VTL5XSUN03 (41" center deck width with pillar post).....	\$439.00/ea.
VTL5XSUN22 (41" center deck width with pillar post).....	\$439.00/ea.

☞ White was not available in 1969 models but may be purchased as a special order.
☞ Sunroof material included with vinyl top.

1970 Coronet & Coronet 500

1970 Belvedere, Roadrunner, Satellite, GTX

VTL4RW01 (41" center deck width w/ pillar post).....	\$379.00/ea.
VTL4RW02 (41" center deck width w/ pillar post).....	\$379.00/ea.
VTL4RW03 (41" center deck width w/ pillar post).....	\$379.00/ea.
VTL4RW151 (Gator Grain 37 1/2" center deck width w/ pillar post) ..	\$1295.00/ea. (L1)

1970 Superbird

VTL4SBIRD01 (37 1/2" center deck width w/ pillar post).....	\$379.00/ea.
---	--------------

1971-72 Roadrunner, Satellite & GTX

VTL7RW01 (Full top - 46" center deck width w/ pillar post).....	\$379.00/ea.
VTL7RW02 (Full top - 46" center deck width w/ pillar post).....	\$379.00/ea.
VTL7RW13 (Full top - 46" center deck width w/ pillar post).....	\$439.00/ea. (L4)

1971-72 Charger & Charger SE

VTL704X01 (Full top - 44" center deck width w/ pillar post).....	\$379.00/ea.
VTL704X02 (Full top - 44" center deck width w/ pillar post).....	\$379.00/ea.
VTL704X13 (Full top - 44" center deck width w/ pillar post).....	\$439.00/ea. (L4)

1973-74 Roadrunner, Satellite, GTX & Charger

VTL704R01 (Full top - 45" center deck width & no pillar post)....	\$379.00/ea.
VTL704R02 (Full top - 45" center deck width & no pillar post)....	\$379.00/ea.
VTL704R13 (Full top - 45" center deck width & no pillar post).....	\$439.00/ea. (L4)

1971-74 Charger & Charger SE

1971-74 Roadrunner, Satellite & GTX

VTL8RX01C/P45C (Cobra)	
(3/4 front "Canopy" top 45" center deck width w/ pillar post).....	\$379.00/ea.
VTL8RX02C/P45C (Cobra)	
(3/4 front "Canopy" top 45" center deck width w/ pillar post).....	\$379.00/ea.

☞ Cobra grain tops were only available on 1973-74 Charger SE models.

VTL804RX01NC/P (Boar)

(3/4 front "Canopy" top - seamless deck w/ pillar post).....	\$379.00/ea.
--	--------------

VTL804RX02NC/P (Boar)

(3/4 front "Canopy" top - seamless deck w/ pillar post).....	\$379.00/ea.
--	--------------

C-BODY MODELS

1967-68 Newport, New Yorker, 300

1967-68 Monaco, Monaco 500, Polara & Polara 500

1967-68 Fury, Sport Fury, VIP

VTL119MP01 (45" center deck width w/ pillar post & <u>no</u> valance).....	\$539.00/ea.
VTL119MP02 (45" center deck width w/ pillar post & <u>no</u> valance).....	\$539.00/ea.
VTL119MP03 (45" center deck width w/ pillar post & <u>no</u> valance).....	\$539.00/ea.
VTL119MP22 (45" center deck width w/ pillar post & <u>no</u> valance).....	\$539.00/ea.

☞ Fits 2dr. "Fast-Top" models only.

1969-71 Fury, Sport Fury, VIP

VTL116F01 (46" center deck width w/ pillar post & valance).....	\$539.00/ea.
VTL116F02 (46" center deck width w/ pillar post & valance).....	\$539.00/ea.
VTL116F03 (46" center deck width w/ pillar post & valance).....	\$539.00/ea.
VTL116F13 (46" center deck width w/ pillar post & valance).....	\$599.00/ea. (L4)
VTL116F22 (46" center deck width w/ pillar post & valance).....	\$539.00/ea.

☞ Fits 2dr. "Formal Roof" models with a rear window measurement of 22" x 64" only.

1969-71 Fury, Sport Fury, VIP

1969-71 Monaco, Monaco 500, Polara & Polara 500

VTL16P01 (46" center deck width w/ pillar post & valance).....	\$539.00/ea.
VTL16P02 (46" center deck width w/ pillar post & valance).....	\$539.00/ea.
VTL16P03 (46" center deck width w/ pillar post & valance).....	\$539.00/ea.
VTL16P13 (46" center deck width w/ pillar post & valance).....	\$599.00/ea. (L4)
VTL16P22 (46" center deck width w/ pillar post & valance).....	\$539.00/ea.

VTL16F151 (Gator Grain 46" center deck w/ pillar post & valance) .. \$1495.00/ea. (L1)
☞ Fits Fury, Sport Fury & VIP 2dr. HTP models with rear window measurement of 24" x 58" only.

1969-71 Newport, New Yorker & 300

VTL18M01 (46" center deck width w/ pillar post & valance).....	\$539.00/ea.
VTL18M02 (46" center deck width w/ pillar post & valance).....	\$539.00/ea.
VTL18M03 (46" center deck width w/ pillar post & valance).....	\$539.00/ea.
VTL18M13 (46" center deck width w/ pillar post & valance).....	\$599.00/ea. (L4)
VTL18M22 (46" center deck width w/ pillar post & valance).....	\$539.00/ea.

☞ Fits Newport, New Yorker & 300 2dr. HTP models with rear window measurement of 24" x 58" only.

1972-73 Newport & New Yorker

1972-73 Monaco & Polara

1972-73 Fury, Sport Fury & Gran Coupe

VTL19F01 (46" center deck width w/ pillar post & valance).....	\$539.00/ea.
VTL19F02 (46" center deck width w/ pillar post & valance).....	\$539.00/ea.
VTL19F13 (46" center deck width w/ pillar post & valance).....	\$539.00/ea. (L4)



VINYL TOPS - CONTINUED

NOS VINYL TOPS

Chrysler offered special order vinyl top colors and grain options such as Gator, Tortoise, Gold Reptile and Mod along with many others that are no longer manufactured and have not been reproduced. In our efforts to better serve you in your restoration needs, NOS (New Old Stock) vinyl top material is continuously being looked for. Please call for more information.

VTNOS \$1129.00/ea.

☞ Please specify year/make/model, color, grain, with or without pillar posts, with or without rear valance & center deck width at time of order.

SUN ROOF VINYL

Additional vinyl top material for 1969-74 B-Body models with factory power or manual sun roof option. Sun roof material is 30" x 48". Please specify at time of order.

1969-74 Boar Grain

- VTSUNUNIV01 (Black no seams)..... \$70.00/ea.
- VTSUNUNIV02 (White no seams)..... \$70.00/ea.
- VTSUNUNIV03 (Antique Green no seams)..... \$70.00/ea.
- VTSUNUNIV13 (Green no seams)..... \$70.00/ea.
- VTSUNUNIV22 (Pearl White no seams)..... \$70.00/ea.

1973-74 Cobra Grain

- VTSUNUNIV01C (Black no seams) \$108.00/ea.
- VTSUNUNIV02C (White no seams) \$108.00/ea.
- VT73SUNCXSE01C (Black with seams)..... \$108.00/ea.
- VT73SUNCXSE02C (White with seams) \$108.00/ea.

☞ Cobra grain for 1973-74 Charger SE models only.

1971-72 DUSTER / DEMON
FOLDING SUN ROOF

Sun roof material manufactured to factory specifications in original KV (Pinpoint) for 1971-72 Duster and Demon models with factory folding sun roof option. Available in black or white, please specify color at time of order.

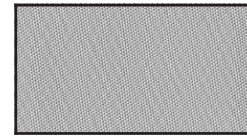

KV "Pinpoint"

- VTSUN71CLV01P (Black pinpoint) \$379.00/ea.
- VTSUN71CLV02P (White pinpoint)..... \$379.00/ea.

VINYL TOP
TERMINOLOGY

Pillar post - The "A" pillar connects the roof to the body located between the windshield and door window. A vinyl top with pillar post runs all the way down the pillar to the bottom of the windshield.

Valance - This is the area under the rear window. If you have a vinyl top with a valance, then the vinyl top would wrap around the underside of the rear window.



Center Deck - The distance between the roof top seams measuring from the center of left seam (driver side) to the center of right seam (passenger side).



COLOR CODES & YEARS APPLICABLE

- (01) Black (1966-1974)
- (02) White (1966-1967 & 1970-74)
- (03) Antique Green (1968-1970)
- (13) Green (1971-1973) **(L4)**
- (22) Pearl White (1968-1969)

CONVERTIBLE TOPS AND ACCESSORIES



Legendary Auto Interiors, Ltd. convertible tops are reproduced to factory original specifications. Convertible tops are available in original KV "Pinpoint" grain (1962-67 models) and Crush "Colonial" grain (1968-70 models). Convertible tops are handcrafted using correct heavyweight 36oz. material. Rear window curtains are available in glass or plastic depending on year, make and model. We also have convertible tops available for most 1950 to present models. For colors other than black and white and models not listed, please call for assistance. As with all Legendary Auto Interiors, Ltd. products, these reproduction convertible tops are the finest available and come with a (2) year manufacturer's warranty (glass curtains come with (1) year warranty) against defects in materials and workmanship.

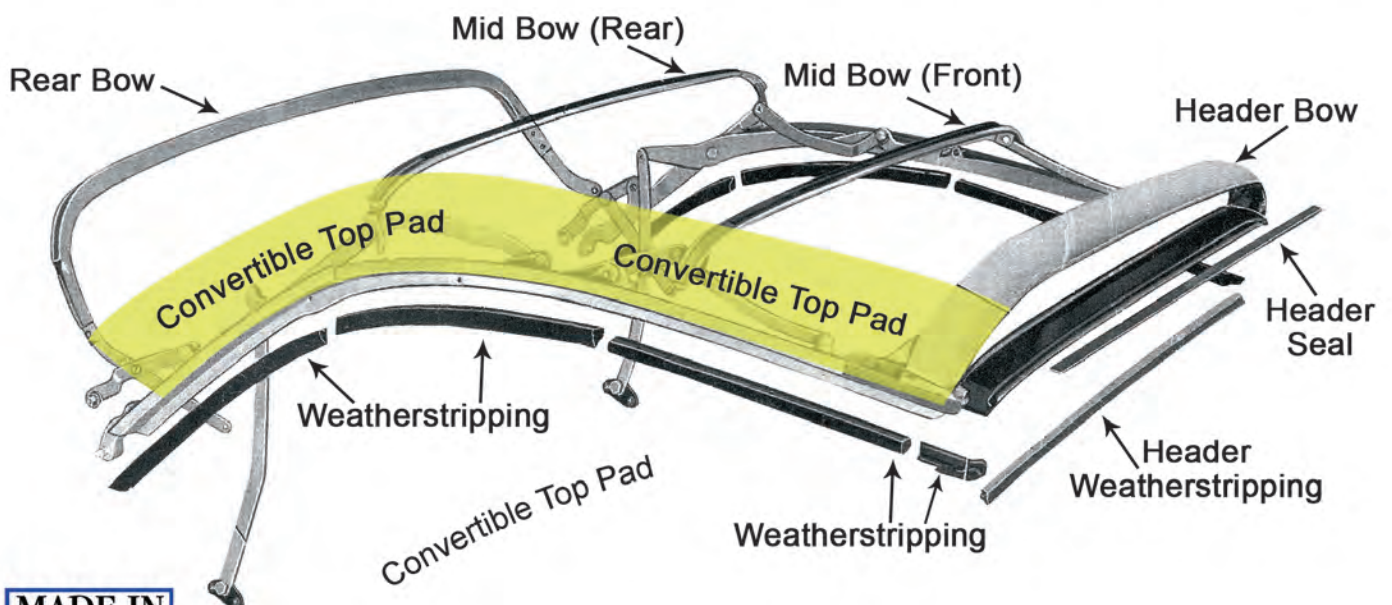

Convertible Top Color Samples

K.V. "Pinpoint Grain" (1962-67)

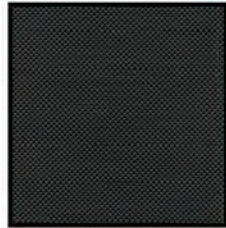

01 Black

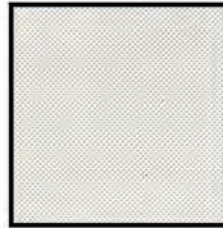

02 White

Crush Grain (1968-70)



01 Black



02 White

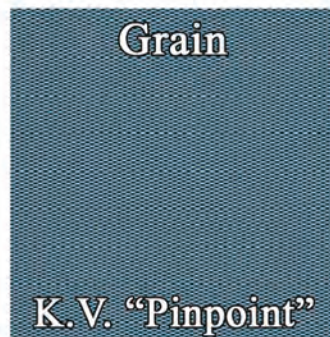

Chrysler, Dodge, Plymouth

CONVERTIBLE TOPS

B-BODY MODELS

1962 Dart, Polara & Polara 500

1962 Fury & Sport Fury

CT62CFLP(C)T (Black and White only) ..\$459.00/ea.

CT62CFLP-P (Plastic curtain only)\$279.00/ea.

1963 Polara & Polara 500

1963 Fury & Sport Fury

CT63CFP(C)T (Black and White only)\$459.00/ea.

CT63CFP(C)P (Plastic curtain only)\$279.00/ea.

1964 Polara, Polara 500, Fury, Sport Fury

1965 Coronet 500, Belvedere II, Satellite

CT64CFPRW(C)T (Black and White only) ..\$459.00/ea.

CT64CFPRW(C)P (Curtain only).....\$279.00/ea.

1966 Coronet & Coronet 500

1966 Belvedere II & Satellite

CT66CRW(C)T (Black and White only)...\$399.00/ea.

CT66CRW-P (Plastic curtain only).....\$279.00/ea.

1967 Coronet & Coronet 500

1967 Belvedere II, Satellite & GTX

CT67CRW(C)T (Black and White only)...\$399.00/ea.

CG67RW(C) (Glass curtain) \$399.00/ea.

1968-70 Coronet & Coronet 500

1968-70 Roadrunner, Satellite & GTX

CT68CRW(C)T (Black and White only)...\$399.00/ea.

CG68RW(C) (Glass curtain) \$399.00/ea.

C-BODY MODELS

1963-64 Chrysler 300 & Newport

CT63CM(C)T (Black and White only)\$509.00/ea.

CT63CM-P (Plastic curtain only)\$279.00/ea.

1965-66 Chrysler 300 & Newport

1965-66 Polara & Polara 500

1965-66 Fury III & Sport Fury

CT65CMFP(C)T (Black and White only) . \$399.00/ea.

CT65CMFP-P (Plastic curtain only).....\$279.00/ea.

1967 Chrysler 300 & Newport

1967 Polara & Polara 500

1967 Fury III & Sport Fury

CT67CFP(C)T (Black and White only)\$399.00/ea.

CG67CF(C) (Glass curtain only) \$399.00/ea.

1968 Chrysler 300 & Newport

1968 Polara & Polara 500

1968 Fury III & Sport Fury

CT68CMFP(C)T (Black and White only) . \$399.00/ea.

CG68CMFP(C) (Glass curtain) \$399.00/ea.

1969-70 Chrysler 300 & Newport

1969-70 Polara

1969-70 Fury III, VIP & Sport Fury

CT69CMFP(C)T (Black and White only) . \$399.00/ea.

CG69CMFP(C) (Glass curtain) \$399.00/ea.

UNIVERSAL CONVERTIBLE TOP PADS



Universal convertible top pads fit between the top and metal frame rails, protecting the top from wear and damage. These will require some trimming but are a less expensive alternative to the OEM style. For the best possible fit, select your year specific OEM convertible top listed on this page. Convertible top pads are highly recommended with installation of new convertible tops.

CTPAD74STD\$79.00/pr.

ANTI-RATTLE PLATES



These plates mount to the frame header to align the top when closing and help to prevent rattling when top in its up position.

CT63AB-ANTIRAT (1963-69 B-Body)\$29.00/pr.





CONVERTIBLE BOOTS

All A, B, C & E-Body convertible boots are sewn to original factory specifications, using original grain vinyls. 1963-65 boot use Bison grain, 1966-68 use Cologne grain, 1969-71 use Coachman grain (except 1969 Dart GT models use Dakota grain). Each boot includes the correct plastic clips or metal snaps and improved padding. Please specify year, make, model and color code at time of order. On two-tone colored interior models, the boot will always match the skirting material on the upholstery. Please refer to the upholstery section in this catalog for correct color code.



www.legendaryautointeriors.com

Chrysler, Dodge, Plymouth

CONVERTIBLE BOOTS

All B & C-Body convertible boots are sewn to original factory specifications, using original grain vinyls. 1963-65 boots use Bison grain, 1966-68 use Cologne grain, 1969-71 use Coachman grain. Each boot includes the correct plastic clips or metal snaps and improved padding. Please specify year, make, model and color code at time of order. On two-tone colored interior models, the boot will always match the skirting material on the upholstery. Please refer to the upholstery section in this catalog for correct color code.



B-BODY MODELS

1963 Polara & Polara 500

- CB63CP00017100 (Black) \$389.00/ea.
- CB63CP00017204 (Dark White) \$389.00/ea.
- CB63CP00017302 (Blue) \$389.00/ea.
- CB63CP00017406 (Lt Turquoise) \$389.00/ea.
- CB63CP00017510 (Crimson Red) \$389.00/ea.

1963 Fury & Sport Fury

- CB63CRW0017100 (Black) \$389.00/ea.
- CB63CRW0017302 (Blue) \$389.00/ea.
- CB63CRW0017510 (Crimson Red) ... \$389.00/ea.

1964 Polara & Polara 500

1964 Fury & Sport Fury

- CB64CRW0017100 (Black) \$389.00/ea.
- CB64CRW0017314 (Lt Met Blue) \$389.00/ea.
- CB64CRW0017416 (Met Turquoise) .. \$389.00/ea.
- CB64CRW0017510 (Crimson Red) ... \$389.00/ea.
- CB64CRW0017606 (Dark Copper) ... \$389.00/ea.
- CB64CRW0017610 (Metallic Fawn) .. \$389.00/ea.
- CB64CRW0017410 (Lt Met Olive) ... \$723.00/ea. (L1)

1965 Coronet & Coronet 500

1965 Belvedere II & Satellite

- CB64CRW0017100 (Black) \$389.00/ea.
- CB64CRW0017202 (Pearl White) \$389.00/ea.
- CB64CRW0017314 (Metallic Blue) \$389.00/ea.
- CB64CRW0017416 (Met Turquoise) .. \$389.00/ea.
- CB64CRW0017510 (Crimson Red) ... \$389.00/ea.
- CB64CRW0017520 (Metallic Red) \$389.00/ea.
- CB64CRW0017610 (Metallic Fawn) .. \$389.00/ea.
- CB64CRW0017614 (Gold) \$389.00/ea.

1966-67 Coronet & Coronet 500

1966-67 Belvedere II, Satellite & GTX

- CB66CRW0017100 (Black) \$353.00/ea.
- CB66CRW0017202 (Pearl White) \$353.00/ea.
- CB66CRW0017318 (Lt Met Blue) \$353.00/ea.
- CB66CRW0017320 (Metallic Navy) ... \$353.00/ea.
- CB66CRW0017420 (Citron) \$353.00/ea.
- CB66CRW0017520 (Metallic Red) \$353.00/ea.
- CB66CRW0017614 (Gold) \$353.00/ea.
- CB66CRW0017620 (Copper) \$353.00/ea.
- CB66CRW0017630 (Gold) \$353.00/ea.

B-BODY MODELS CONT.

1968 Coronet & Coronet 500

1968 Roadrunner, Satellite & GTX

- CB68CRW0017100 (Black) \$469.00/ea.
- CB68CRW0017202 (Pearl White) \$469.00/ea.
- CB68CRW0017330 (Dk Met Blue) \$469.00/ea.
- CB68CRW0017332 (Lt Met Blue) \$469.00/ea.
- CB68CRW0017430 (Dk Met Green) .. \$469.00/ea.
- CB68CRW0017526 (Met Maroon) \$469.00/ea.
- CB68CRW0017630 (Gold) \$469.00/ea.

* Due to vinyl length restrictions we are unable to reproduce 330 Dark Metallic Blue & 630 Gold convertible boots in original Coachman grain without adding a non-original center seam.

1969-70 Coronet & Coronet 500

1969-70 Roadrunner, Satellite & GTX

- CB69CRW0017100 (Black) \$469.00/ea.
- CB69CRW0017154 (Charcoal) \$469.00/ea.
- CB69CRW0017200 (White) \$469.00/ea.
- CB69CRW0017330 (Dk Met Blue) \$469.00/ea.
- CB69CRW0017338 (Bright Blue) \$469.00/ea.
- CB69CRW0017434 (Dk Met Green) .. \$469.00/ea.
- CB69CRW0017528 (Red) \$469.00/ea.
- CB69CRW0017540 (Burnt Orange) ... \$469.00/ea.
- CB69CRW0017640 (Bronze) \$469.00/ea.
- CB69CRW0017650 (Saddle) \$469.00/ea.
- CB69CRW0017656 (Brown) \$469.00/ea.

* Due to vinyl length restrictions we are unable to reproduce 154 Charcoal & 528 Red convertible boots in original Coachman grain without adding a non-original center seam.

C-BODY MODELS

1963-64 Chrysler 300 & Newport

- CB63CM00017100 (Black) \$462.00/ea.
- CB63CM00017202 (Pearl White) \$462.00/ea.
- CB63CM00017204 (Dark White) \$462.00/ea.
- CB63CM00017206 (Taupe) \$462.00/ea.
- CB63CM00017314 (Metallic Blue) \$462.00/ea.
- CB63CM00017339 (Metallic Blue) \$462.00/ea.
- CB63CM00017406 (Turquoise) \$462.00/ea.
- CB63CM00017520 (Metallic Red) \$462.00/ea.
- CB63CM00017530 (Claret Red) \$462.00/ea.
- CB63CM00017610 (Metallic Fawn) ... \$462.00/ea.

1965 Polara & Polara 500

1965 Fury III & Sport Fury

- CB65CFP0017100 (Black) \$462.00/ea.
- CB65CFP0017314 (Met Blue) \$462.00/ea.
- CB65CFP0017320 (Metallic Navy) .. \$462.00/ea.
- CB65CFP0017414 (Dk Met Turq) ... \$462.00/ea.
- CB65CFP0017520 (Metallic Red) \$462.00/ea.
- CB65CFP0017614 (Gold) \$462.00/ea.

1965 Chrysler 300 & 300L

- CB65CM00017100 (Black) \$462.00/ea.
- CB65CM00017202 (Peral White) \$462.00/ea.
- CB65CM00017322 (Met Blue) \$462.00/ea.
- CB65CM00017520 (Metallic Red) \$462.00/ea.
- CB65CM00017610 (Metallic Fawn) . \$462.00/ea.
- CB65CM00017614 (Gold) \$462.00/ea.

C-BODY MODELS CONT.

1966 Polara & Polara 500

1966 Fury III & Sport Fury

1966 Chrysler 300

- CB66CFP0017100 (Black) \$462.00/ea.
- CB66CFP0017102 (Silver) \$462.00/ea.
- CB66CFP0017202 (Pearl White) \$462.00/ea.
- CB66CFP0017318 (Lt Met Blue) \$462.00/ea.
- CB66CFP0017320 (Met Navy) \$462.00/ea.
- CB66CFP0017420 (Citron) \$462.00/ea.
- CB66CFP0017520 (Metallic Red) ... \$462.00/ea.
- CB66CFP0017614 (Gold) \$462.00/ea.
- CB66CFP0017616 (Ginger) \$462.00/ea.

1967-68 Fury III & Sport Fury

- CB67CF00017100 (Black) \$462.00/ea.
- CB67CF00017202 (Pearl White) \$462.00/ea.
- CB67CF00017318 (Lt Met Blue) \$462.00/ea.
- CB67CF00017332 (Lt Met Blue) \$462.00/ea.
- CB67CF00017430 (Dk Met Green) .. \$462.00/ea.
- CB67CF00017520 (Metallic Red) ... \$462.00/ea.
- CB67CF00017620 (Copper) \$462.00/ea.

1967-68 Chrysler 300 & Newport

- CB67CM00017100 (Black) \$462.00/ea.
 - CB67CM00017202 (Pearl White) \$462.00/ea.
 - CB67CM00017318 (Lt Met Blue) \$462.00/ea.
 - CB67CM00017330 (Dk Met Blue) ... \$462.00/ea.
 - CB67CM00017520 (Metallic Red) ... \$462.00/ea.
- * Due to vinyl length restrictions we are unable to reproduce (330) Dark Metallic Blue convertible boots in original Cologne grain without adding a non-original center seam.

1967-68 Polara & Polara 500

- CB67CP00017100 (Black) \$462.00/ea.
- CB67CP00017202 (Pearl White) \$462.00/ea.
- CB67CP00017318 (Lt Met Blue) \$462.00/ea.
- CB67CP00017332 (Lt Met Blue) \$462.00/ea.
- CB67CP00017520 (Metallic Red) ... \$462.00/ea.

1969-70 Chrysler 300 & Newport

- CB69CM00017100 (Black) \$462.00/ea.
- CB69CM00017200 (White) \$462.00/ea.
- CB69CM00017332 (Lt Met Blue) \$462.00/ea.
- CB69CM00017336 (Navy Blue) \$462.00/ea.
- CB69CM00017434 (Dk Met Green) ... \$462.00/ea.
- CB69CM00017650 (Saddle) \$462.00/ea.
- CB69CM00017656 (Brown) \$462.00/ea.

1969 Polara & Polara 500

1969 Fury III & Sport Fury

- CB69CFP0017100 (Black) \$462.00/ea.
- CB69CFP0017200 (White) \$462.00/ea.
- CB69CFP0017330 (Dk Met Blue) ... \$462.00/ea.
- CB69CFP0017332 (Lt Met Blue) \$462.00/ea.
- CB69CFP0017432 (Lt Met Green) ... \$462.00/ea.
- CB69CFP0017528 (Red) \$462.00/ea.

1970 Polara

1970 Fury III

- CB70CFP0017100 (Black) \$462.00/ea.
- CB70CFP0017154 (Charcoal) \$462.00/ea.
- CB70CFP0017332 (Lt Met Blue) \$462.00/ea.
- CB70CFP0017432 (Lt Met Green) .. \$462.00/ea.
- CB70CFP0017434 (Dk Met Green) ... \$462.00/ea.



CONVERTIBLE BOOT CLIPS



B-Body Clip

Reproduction plastic clips that get sewn into the convertible top boot for attachment.

CB68B-CLIP (1968-70 B-Body)\$5.00/ea.

CONVERTIBLE BOOT DUST COVER

Protect your convertible boot when you remove it with this convertible boot dust cover made in Levant grain with a satin finish. Comes in Black only



CB67MCBAG01 \$72.00/ea.

CONVERTIBLE TOP LATCH



1965-68 C-Body & 1966-70 B-Body convertible top latch

CT65ABC-LATCH\$169.00/pr.

CONVERTIBLE BODY SCREW STUDS



5/8" Phillips head stainless steel body screw studs for snap down boot and well liner applications.

CBBOOTBEZSCRW (Pkg/35)\$16.00/pk.

CONVERTIBLE WELL LINERS

Legendary Auto Interiors, Ltd. convertible top well liners for A, B, C & E-Body models are manufactured to original specifications with plastic strips and snaps (where applicable) for easy installation. The well liner installs behind the convertible rear seat protecting the top from damage when placed in the down position. Available in black for all years or in matching colors for 1963-65 model interiors.

B-BODY MODELS

1963 Polara & Polara 500

- WL63CP00016100** (Black).....\$222.00/ea.
- WL63CP00016206** (Taupe).....\$222.00/ea.
- WL63CP00016302** (Blue).....\$222.00/ea.
- WL63CP00016406** (Lt Turquoise)....\$222.00/ea.
- WL63CP00016510** (Crimson Red)...\$222.00/ea.

1963 Fury & Sport Fury

- WL63CFR0016100** (Black).....\$222.00/ea.
- WL63CFR0016302** (Blue).....\$222.00/ea.
- WL63CFR0016510** (Crimson Red)..\$222.00/ea.

1964 Polara & Polara 500

1964 Fury & Sport Fury

- WL64CRW0016100** (Black).....\$222.00/ea.
- WL64CRW0016314** (Lt Met Blue)....\$222.00/ea.
- WL64CRW0016416** (Met Turq).....\$222.00/ea.
- WL64CRW0016510** (Crimson Red).\$222.00/ea.
- WL64CRW0016606** (Dark Copper)..\$222.00/ea.
- WL64CRW0016610** (Metallic Fawn)\$222.00/ea.
- WL64CRW0016410** (Met Olive).\$515.00/ea. (L1)

1965 Coronet & Coronet 500

1965 Belvedere II & Satellite

- WL64CRW0016100** (Black).....\$222.00/ea.
- WL64CRW0016314** (Lt Met Blue)....\$222.00/ea.
- WL64CRW0016416** (Met Turq).....\$222.00/ea.
- WL64CRW0016510** (Crimson Red).\$222.00/ea.
- WL64CRW0016520** (Metallic Red)..\$222.00/ea.
- WL64CRW0016610** (Metallic Fawn)\$222.00/ea.
- WL64CRW0016614** (Gold).....\$222.00/ea.

1966-67 Coronet & Coronet 500

1966-67 Belvedere II, Satellite & GTX

- WL66CRW0016100** (16 snaps).....\$222.00/ea.
- WL66CW00016100** (18 snaps).....\$222.00/ea.
- WL66CR00016100** (20 snaps).....\$222.00/ea.

☞ Please specify number of snaps at time of order.

☞ Available in black only.

1968-70 Coronet & Coronet 500

1968-70 Roadrunner, Satellite & GTX

- WL68CRW0016100** (shown).....\$222.00/ea.

☞ Available in black only.



C-BODY MODELS

1963-64 Chrysler 300 & Newport

- WL63CM00016100** (Black).....\$267.00/ea.
- WL63CM00016206** (Taupe).....\$267.00/ea.
- WL63CM00016314** (Metallic Blue)....\$267.00/ea.
- WL63CM00016339** (Metallic Blue)....\$267.00/ea.
- WL63CM00016406** (Turquoise).....\$267.00/ea.
- WL63CM00016520** (Metallic Red)....\$267.00/ea.
- WL63CM00016530** (Claret Red).....\$267.00/ea.
- WL63CM00016610** (Metallic Fawn)...\$267.00/ea.

1965-66 Chrysler 300 & Newport

1965-66 Polara & Polara 500

1965-66 Fury III & Sport Fury

- WL65CFMP016100** (Black).....\$267.00/ea.
- WL65CFMP016314** (Met Blue).....\$267.00/ea.
- WL65CFMP016320** (Met Navy).....\$267.00/ea.
- WL65CFMP016322** (Med Met Blue)..\$267.00/ea.
- WL65CFMP016414** (Dk Met Turq)....\$267.00/ea.
- WL65CFMP016520** (Metallic Red)....\$267.00/ea.
- WL65CFMP016610** (Met Fawn).....\$267.00/ea.
- WL65CFMP016614** (Gold).....\$267.00/ea.

☞ 1966 models available in black only.

1967-68 Chrysler 300 & Newport

- WL67CM00016100** (Black).....\$267.00/ea.

☞ Available in black only.

1967-68 Fury III & Sport Fury

- WL67CF00016100** (Black).....\$267.00/ea.

☞ Available in black only.

1969-70 Chrysler 300 & Newport

- WL69CM00016100** (Black).....\$267.00/ea.

☞ Available in black only.

1969-70 Polara & Polara 500

1969-70 Fury III & Sport Fury

- WL69CFP0016100** (Black).....\$267.00/ea.

☞ Available in black only.



Providing the automotive industry
with the world's highest quality
soft trim products and services
RIGHT HERE AT HOME

**STILL ASSEMBLED AND
MADE IN THE** ★★★★★
USA 

THERE REALLY IS A DIFFERENCE!!



Legendary
AUTO INTERIORS LTD.®



www.legendaryautointeriors.com





WEATHERSTRIPING AND ACCESORIES

 facebook.com/legendaryautointeriors
 twitter.com/legendaryautoin

 www.legendaryautointeriors.com
 instagram.com/legendaryautointeriorsltd
 youtube.com/user/legendaryauto

Chrysler, Dodge, Plymouth

BODY PLUG KITS



Complete body plug kits for floor pans, trunk pans and trunk extensions contain the correct size and style plugs in plastic or rubber depending on location and application of each year and model.

B-BODY MODELS

1963 Polara & Polara 500
1963 Fury, Sport Fury, Belvedere & Savoy
 BP63B \$59.00/kit

1964 Polara & Polara 500
1964-65 Fury & Sport Fury
 BP64CF \$59.00/kit

1964-65 330, 440, Coronet & Coronet 500
1964-65 Belvedere, Savoy & Satellite
 BP64CR \$49.00/kit

1966-67 Charger
 BP66CX \$59.00/kit

1966-67 Coronet, Coronet 500
1966-67 Belvedere II, Satellite & GTX
 BP66B \$59.00/kit

1968 Coronet, Coronet 500 & Charger
1968 Roadrunner, Satellite & GTX
 BP68B \$69.00/kit

1969 Coronet, Charger & Daytona
1969 Roadrunner, Satellite & GTX
 BP69B \$69.00/kit

1970 Coronet, Coronet 500 & Charger
1970 Roadrunner, Satellite, GTX & Superbird
 BP70B (shown) \$69.00/kit

1971-72 Charger
1971-72 Roadrunner, Satellite & GTX
 BP71B \$69.00/kit

1973-74 Charger
 BP73CX \$69.00/kit

1973-74 Roadrunner, Satellite & GTX
 BP73CR \$69.00/kit

BODY BUMPER KITS

Complete body bumper kits for 1963-74 B & C-Body models. These kits include all of the body bumpers on your car from the hood to the trunk. Spring-loaded hood wedges are included in 1969-74 kits where applicable.

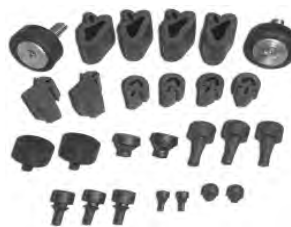

B-BODY MODELS

1964 Fury & Sport Fury
1964-65 Belvedere, Savoy & Satellite
1964 Polara & Polara 500
1964-65 330, 440, Coronet & Coronet 500
 BU64CRW-C \$29.00/kit

1966-67 Coronet, Coronet 500 & Charger
1966-67 Belvedere II, Satellite & GTX
 BU66CRWX-C \$29.00/kit

1968-70 Coronet & Coronet 500
 BU68CW-C \$29.00/kit

1968-70 Charger
1969 Daytona
 BU68CX-C (shown) \$29.00/kit

1968-70 Roadrunner, Satellite & GTX
1970 Superbird
 BU68CR-C \$29.00/kit

1971 Charger
1971 Roadrunner, Satellite & GTX
 BU71CRX-C \$59.00/kit

1972 Charger
1972 Roadrunner, Satellite & GTX
 BU72CRX-C \$59.00/kit

1973-74 Charger
 BU73CWX-C \$59.00/kit

1973-74 Roadrunner, Satellite & GTX
 BU73CR-C \$59.00/kit

C-BODY MODELS

1968 Newport & 300
 BU68CM-C \$39.00/kit

1969 Polara & Monaco
 BU69CP-C \$59.00/kit

1969 Fury III & Sport Fury
 BU69CF-C \$59.00/kit

1970 Polara & Monaco
 BU70CP-C \$59.00/kit

1970 Fury III & Sport Fury
 BU70CF-C \$59.00/kit

1971 Polara & Monaco
 BU71CP-C \$59.00/kit

1971 Fury III & Sport Fury
 BU71CF-C \$59.00/kit

1972-74 Polara & Monaco
 BU72CP-C \$59.00/kit

1972-73 Fury III & Sport Fury
 BU72CF-C \$59.00/kit

SPRING-LOADED HOOD BUMPERS

Spring-loaded hood bumpers for 1971-74 B-Body and 1969-74 C-Body models. This wedge-shaped bumper keeps the hood in alignment.



BU69WEDGE \$15.00/ea.



TRUNK BUMPER KIT

Rubber bumpers for 1966-74 B & C-Body models keeps the trunk lid in alignment. (NOTE: Contents of this kit are also included in the complete body bumper kits)

BU66ABTRNK \$3.00/ea.

HOOD BUMPER KITS

Bumper kit includes all the necessary bumpers for under the hood of your car. (NOTE: Contents of this kit are also included in the complete body bumper kits)

B-BODY MODELS

**1964 Polara & Polara 500
1964 Fury & Sport Fury**
BU64CRW-H \$29.00/kit

**1964-65 330, 440, Coronet & Coronet 500
1964-65 Belvedere, Savoy & Satellite**
BU64CRW-H \$29.00/kit

**1966-67 Coronet, Coronet 500 & Charger
1966-67 Belvedere II, Satellite & GTX**
BU66CRWX-H \$29.00/kit

**1968-70 Charger
1969 Daytona**
BU68CX-H \$29.00/kit

**1968-70 Coronet & Coronet 500
1968-70 Roadrunner, Satellite & GTX
1970 Superbird**
BU68CRW-H \$29.00/kit

**1971-74 Charger
1971-74 Roadrunner, Satellite & GTX**
BU71CRX-H \$59.00/kit

C-BODY MODELS

**1969-74 Chrysler 300
1969-74 Newport & New Yorker
1969-74 Polara & Monaco
1969-74 Fury III & Sport Fury**
BU69CFPM-H \$59.00/kit

ACCELERATOR GASKETS

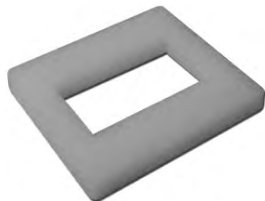

Die-cut white foam gaskets install under the accelerator pedal to prevent water damage.

1966-70 B-Body (all models)
GK66B-ACCEL (shown) \$5.00/ea.

1971-74 B-Body (all models)
GK70EB-ACCEL \$5.00/ea.

DOOR HANDLE GASKETS



Die-cut door handle gaskets mount between the door handle and door.

1967-70 B-Body (all models)
GK67AB-DH (Rubber) (shown) \$5.00/pr.

DOOR & TRUNK LOCK GASKETS



Gray plastic door and trunk lock gaskets for 1966-71 B & C-Body models mount between the lock mechanism and body.

GK66LOCKDT \$5.00/kit

DOOR WINDOW WEATHERSTRIPPING PLUG



"Fuzzy" coated rubber strip plugs into the inner door at the end of the window sweeps. For all 1968-70 B-Body models.

WS68C-BPLUG \$19.00/pr.

WINDOW TRIM CLIPS



Trim clip kits include both front windshield and rear window clips (where applicable) for fastening trim molding. Mounting screws included.

B-BODY MODELS

**1962 Dodge 440, Dart & Polara
1962 Belvedere, Fury & Sport Fury**
WG62CFLPR-CLIP (Hardtop) \$59.00/kit
WG62CFLPRC-CLIP (Convertible) \$29.00/kit

**1963 Dodge 440, Polara & Polara 500
1963 Belvedere, Fury & Sport Fury**
WG63CFPR-CLIP (Hardtop) \$39.00/kit
WG62CFLPRC-CLIP (Convertible) \$29.00/kit

**1964 Dodge 330, 440, Polara & Polara 500
1964 Savoy, Belvedere, Fury & Sport Fury**
WG64CPRWH-CLIP (Hardtop) \$59.00/kit
WG64CPRWS-CLIP (Sedan) \$59.00/kit
WG64CPRWC-CLIP (Convertible) \$39.00/kit

**1965 Coronet & Coronet 500
1965 Belvedere, Belvedere I,
Belvedere II & Satellite**
WG64CPRWH-CLIP (Hardtop) \$57.00/kit
WG64CPRWS-CLIP (Sedan) \$57.00/kit
WG64CPRWC-CLIP (Convertible) \$39.00/kit

**1966-67 Coronet, Coronet 500
1966-67 Belvedere II, Satellite & GTX**
WG66CRWX-CLIP (Hardtop) \$59.00/kit
WG66CRWXC-CLIP (Convertible) \$39.00/kit

1966-67 Charger
WG66CX-CLIP \$39.00/kit

**1968-70 Charger
1969 Daytona**
WG68CX-CLIP \$59.00/kit

**1968-70 Coronet & Coronet 500
1968-70 Roadrunner, Satellite & GTX
1970 Superbird**
WG68CRW-CLIP (Hardtop) \$59.00/kit
WG68CRWC-CLIP (Convertible) \$39.00/kit

**1971-74 Charger
1971-74 Roadrunner, Satellite & GTX**
WG71CRX-CLIP \$59.00/kit

Chrysler, Dodge, Plymouth

WINDSHIELD GASKETS

Remanufactured rubber windshield gaskets made as original for B, C-Body and Dodge pickups.

B-BODY MODELS

1962-63 Dodge 440, Polara & Polara 500
1962-63 Belvedere, Fury & Sport Fury
WG62CRW-WG (Hardtop) \$119.00/ea.

1964 Dodge 440, Polara & Polara 500
1964 Belvedere, Fury & Sport Fury
WG64CRW-WG (Hardtop) \$119.00/ea.
WG64CFPRW-WG (Convertible) \$119.00/ea.

1965 Coronet & Coronet 500
1965 Belvedere II & Satellite
WG64CRW-WG (Hardtop) \$119.00/ea.
WG64CFPRW-WG (Convertible) \$119.00/ea.

1966-67 Coronet, Coronet 500 & Charger
1966-67 Belvedere II, Satellite & GTX
WG66CRW-WG (Hardtop) \$119.00/ea.

1968-70 Coronet, Coronet 500 & Charger
1969 Daytona
1968-70 Roadrunner, Satellite & GTX
1970 Superbird
WG68CRW-WG
(2-Door Hardtop & Sedan) \$119.00/ea.

C-BODY MODELS

1965-66 Chrysler 300
1965-66 Newport & New Yorker
1965-66 Polara, Polara 500 & Monaco
1965-68 Fury III & Sport Fury
WG65CFMP-WG (2-door Hardtop) .. \$119.00/ea.

1965-68 Chrysler 300
1965-68 Newport & New Yorker
1965-68 Polara & Polara 500
1965-68 Fury III & Sport Fury
WG65CFMP-WG (Convertible) \$119.00/ea.

1965-68 Chrysler 300
1965-68 Newport & New Yorker
1965-68 Polara & Monaco
1965-68 Fury II & Fury III
WG65CFMP-WG (4-door Hardtop) .. \$119.00/ea.

DODGE TRUCK

1972-93 Dodge Pickup
WG72CDT-WG \$119.00/ea.

DOOR WEATHERSTRIPPING

Thick molded rubber weatherstrip includes the necessary clips and correct molded endpads for an excellent fit. These pieces wrap around the bottom and sides of each door.

1966-67 B-Body (all models)
WS66C-BDOOR (Hardtop/Conv.) \$139.00/pr.

1966-67 B-Body (all models)
WS66C-BDOORS (Sedan) \$139.00/pr.

1968-70 B-Body (all models)
WS68C-BDOOR (Hardtop/Sedan/Conv.) .. \$139.00/pr.

1971-74 B-Body (all models)
WS71C-BDOOR (Hardtop/Conv.) \$129.00/pr.

REAR WINDOW GASKETS

Remanufactured rubber rear window gaskets made as original for B-Body models where applicable.

B-BODY MODELS

1964 Dodge 330, 440, Polara & Polara 500
1964 Belvedere, Savoy, Fury & Sport Fury
WG64CRWH-RG (Hardtop) \$119.00/ea.
WG64CRW-RG (Sedan) \$119.00/ea.

1965 Coronet & Coronet 500
1965 Belvedere I, II & Satellite
WG64CRWH-RG (Hardtop) \$119.00/ea.
WG64CRW-RG (Sedan) \$119.00/ea.

1966-67 Charger
WG66CX-RG (Fastback) \$209.00/ea.
⚠ Will not work for 1966-67 Charger models with vinyl top option.

1966-67 Coronet, Coronet 500
1966-67 Belvedere II, Satellite & GTX
WG66CRW-RG (Hardtop) \$249.00/ea.

DOOR WINDLACE WEATHERSTRIP

Reproduction door windlace with steel core for 1962-65 2-Door models. This windlace pushes onto the lip of the door jamb sealing the doors when shut.

WS62C-DOOR(C) (Hardtop/Conv.) \$169.00
WS62C-SDOOR(C) (Sedan) \$189.00
⚠ Available colors: (01) Black, (03) Red, (11) Light Blue, (50) Turquoise.

DOOR WEATHERSTRIPPING CLIPS



Plastic door weatherstripping kits replace missing or broken originals. For all 1966 and later models. (NOTE: These clips are replacements only and are already included with the door weatherstripping shown above)

WS63CDOORCLIPS (22/pkg) \$15.00/pk.

DOOR LOCK SEALS



These molded rubber "U" shaped seals screw onto the door jamb pillar to seal the front edge of the rear-down windows.

1968-70 B-Body (all models)
WS68C-BDOORLOCK \$49.00/pr.

DOOR END/LOCK SEAL SCREW



Black #8 door-end and door-lock 3/8" screw replaces broken or missing originals on all B & E-Body 2-door models.

WS68DOORSCREW (10/pkg) \$10.00/pk.

DOOR END SEALS



Molded rubber seals mount to end of the door next to the top of the door weatherstripping and are attached with screws.

1968-70 B-Body (all models)
WS68C-BDOOREND (shown) \$49.00/pr.



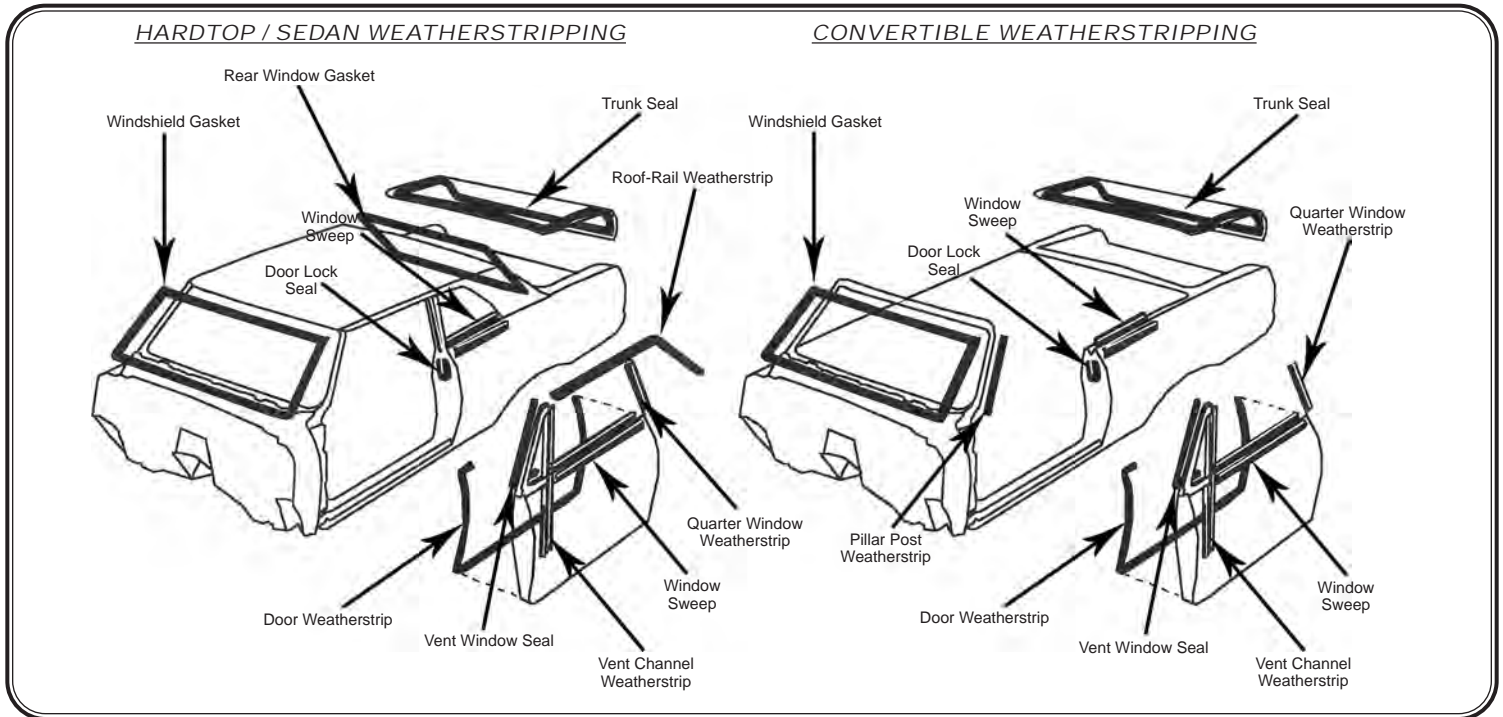

ROOF RAIL WEATHERSTRIPPING

Thick molded rubber with correct molded endpads. These start at the base of the windshield pillar post and follow along the outer edge of the roofline to the rear of the quarter window.

- 1962-63 B-Body (all models)**
WS62C-BROOF (Hardtop).....\$109.00/pr.
- 1964-65 B-Body (all models)**
WS64C-BROOF (Hardtop).....\$129.00/pr.
- 1966-67 B-Body (all models except Charger)**
WS66C-BROOF (Hardtop).....\$129.00/pr.
- 1966-67 B-Body (Charger)**
WS66CXROOF (Fastback).....\$129.00/pr.
- 1968-70 B-Body (all models)**
WS68C-BROOFN (Hardtop).....\$129.00/pr.
WS68C-BROOF (Sedan w/ post).....\$129.00/pr.
- 1971-74 B-Body**
WS71C-BROOF (Hardtop).....\$129.00/pr.
☞ Will not work on all 72 & 74 Charger SE models.
☞ Will not work on 73 Charger SE models with 3-louvered quarter windows.
- 1975-79 B-Body (all models)**
WS75C-BROOF (Hardtop).....\$169.00/pr.

REAR QUARTER WINDOW SEALS

Rubber seals install into the chrome tracks located on the front edge of the quarter windows for some models and on the back edge of the door windows for others.

- 1966-67 B-Body (all models)**
WS66C-BQTR (Hardtop/Fastback)..... \$29.00/pr.
- 1966-70 B-Body (all models)**
WS66C-BQTR (Convertible)..... \$16.00/pr.
- 1968-70 B-Body (all models)**
WS68C-BQTRH (Hardtop)..... \$39.00/pr.

TRUNK SEALS

Correct original profile extruded foam for hardtop and convertible models seals the trunk lid preventing water leaks.

- 1966-67 B-Body (all models except Charger)**
TS66CRW (Hardtop & Convertible).... \$59.00/ea.
- 1966-67 B-Body (Charger)**
TS66CX (Fastback)..... \$59.00/ea.
- 1968-69 Coronet & Coronet 500**
TS68CW (Hardtop & Convertible)..... \$59.00/ea.
- 1968-69 Roadrunner, Satellite & GTX**
TS68CR (Hardtop & Convertible).....\$59.00/ea.
- 1968-70 Charger**
TS68CX (Hardtop).....\$59.00/ea.
- 1970 B-Body (all models except Charger)**
TS70CRW (Hardtop & Convertible).....\$59.00/ea.
- 1971-72 B-Body (all models)**
TS71CRX (Hardtop).....\$49.00/ea.
- 1973-74 B-Body (all models)**
TS73CRX (Hardtop).....\$29.00/ea.
- 1967-68 C-Body (all models)**
TS67CM (Hardtop & Convertible).....\$29.00/ea.

Chrysler, Dodge, Plymouth

CHRYSLER "V-FOAM" TRUNK SEAL



Extruded "V" shape foam for all 1963-74 models seals the trunk lid preventing water leaks. Please measure original seal for correct footage when ordering.

TS63VFOAM \$5.00/ft.

VENT CHANNEL WEATHERSTRIPPING

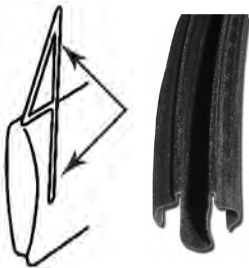

U-shaped strip that fits on the backside of the vent window channel where the door window rolls up into.

1962-63 B-Body (all models)
WS62C-BVENT38 (Hardtop)..... \$69.00/pr.

1962-65 B-Body (all models)
WS62C-BVENT39 (Sedan)..... \$69.00/pr.

1964-65 B-Body (all models)
WS64C-BVENT30.5 (Hardtop)..... \$79.00/pr.

VENT WINDOW SEAL



Rubber "wing" vent window seal fits inside the framing for the glass vent window.

1968-70 B-Body (all models)
WS68C-BVENTSEAL (shown) \$129.00/pr.

1978-1986 Dodge Pickup
WS78D150VENTSEAL..... \$59.00/ea.

CONVERTIBLE TOP FRAME WEATHERSTRIPPING

CONVERTIBLE TOP FRAME WEATHERSTRIPPING KITS

Complete convertible top frame kits consist of (1) rubber header seal, (1) secondary rubber header seal and (6) molded rubber side rail pieces.

1962-65 B-Body (all models)
WS62CFPRWTOP \$229.00/kit

1966-70 B-Body (all models)
WS66CBLRVWXTOP \$149.00/kit

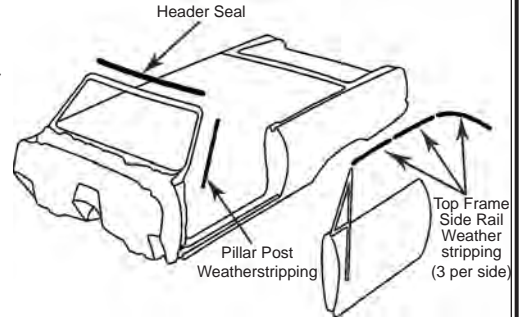

PILLAR POST WEATHERSTRIPPING

These weatherstrip pieces run along the side of the windshield frame.

1966-70 B-Body (all models)
WS66CRWXPOST \$89.00/pr.

HEADER SEALS

Rubber header seal runs along the front of the top and seals against the top of the windshield.

1962-65 B-Body (all models)
WS62CFPRWHS..... \$79.00/ea.

1966-70 B-Body (all models)
WS66CRWXHS..... \$89.00/ea.

Hood-to-Cowl Seal

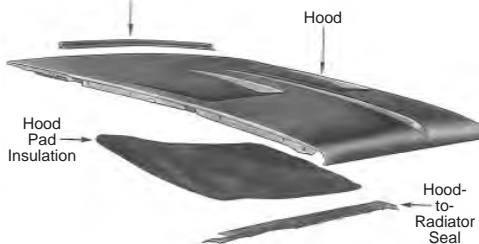

TYPICAL HOOD SEAL
INSTALLATION
(1968 CHARGER HOOD SHOWN)

HOOD-TO-COWL SEALS



This rubber piece seals to the underside of the hood to the front edge of the cowl.

1962-65 B-Body (all models)
WS62C-BHOOD..... \$89.00/ea.

1966-70 B-Body (all models)
WS66C-BHOOD..... \$19.00/ea.
WS66C-BHOOD1 (w/ clips installed)... \$99.00/ea.

1971-74 B-Body (all models)
WS71C-BHOOD1 (w/ clips installed)... \$79.00/ea.

HOOD-TO-RADIATOR SEALS



Correctly formed and shaped rubber strip that seals the hood to the radiator core support.

1962-65 B-Body "Narrow Type"
WS62CRW-HRN (w/ clips installed) \$79.00/ea.

1962-65 B-Body "Wide Type"
WS62CRW-HRW (w/ clips installed).... \$49.00/ea.

1966-67 B-Body (all models)
WS66CRWX-HR (w/ clips installed) \$89.00/ea.

1968-70 B-Body (all models)
WS68CRWX-HR (clips included) \$49.00/ea.

1971-72 B-Body (all models)
WS71CRX-HR (w/ clips installed)..... \$99.00/ea.

1973-74 B-Body (all models)
WS73CRX-HR (w/ clips installed)..... \$89.00/ea.

HOOD PAD INSULATION

Die-cut reproductions of the original hood insulation pads ready to install. Clips not included.



B-BODY MODELS

1963-64 Belvedere, Savoy, Fury & Sport Fury

- HP63CF1 (1" thick)..... \$49.00/ea.
- HP63CF1/2 (1/2" thick)..... \$39.00/ea.
- ☞ 1963 requires 16 clips, 1964 requires 20 clips

1964 Polara & Polara 500

- 1965 Coronet & Coronet 500
- HP64CPW1 (1" thick) (21 clips)..... \$29.00/ea.
- HP64CPW1/2 (1/2" thick) (21 clips)..... \$29.00/ea.

1965 Belvedere II & Satellite

- HP65CR (requires 22 clips)..... \$39.00/ea.

**1966-67 Coronet, Coronet 500 & Charger
1966-67 Belvedere II, Satellite & GTX**

- HP66CRWX (requires 28 clips)..... \$29.00/ea.

**1968-69 Coronet, Coronet 500 & Charger
1968-69 Roadrunner, Satellite & GTX**

- HP68CRWX (requires 26 clips)..... \$39.00/ea.

**1970 Coronet, Coronet 500 & Charger
1970 Roadrunner, Satellite & GTX**

- HP70CRW (requires 23 clips)..... \$29.00/ea.

1971-74 Charger

- HP70CBJX (requires 20 clips)..... \$29.00/ea.

1971-74 Roadrunner, Satellite & GTX

- HP71CRW (requires 20 clips)..... \$39.00/ea.

C-BODY MODELS

1961-70 Chrysler 300 & Newport

- HP62CM (1961-62) (requires 19 clips).. \$39.00/ea.
- HP63CM (1963-64) (requires 22 clips).. \$49.00/ea.
- HP65CM (1965-68) (requires 26 clips).. \$49.00/ea.
- HP69CM (1969-70) (requires 19 clips)... \$39.00/ea.

**1965-68 Polara & Polara 500
1965-68 Fury III & Sport Fury**

- HP65CFP (requires 26 clips)..... \$49.00/ea.

DODGE TRUCK

1967-71 Dodge Truck

- HP67CDT..... \$29.00/ea.

MOLDED HOOD PAD

These pads are molded to the shape of the hood as original. Due to size of these hood pads, they are shipped oversize.



- 1966-67 B-Body (all models)^{OS3}
HP66CRWXM (requires 28 clips)..... \$119.00/ea.

- 1968-69 B-Body (all models)^{OS3}
HP68CRWXM (requires 26 clips)..... \$119.00/ea.

- 1970 B-Body (all models)^{OS3}
HP70CRWM (requires 23 clips)..... \$119.00/ea.

- 1971-74 B-Body (Charger only)^{OS3}
HP70CBJXM (requires 20 clips)..... \$119.00/ea.

- 1971-74 B-Body (Roadrunner, Satellite & GTX)^{OS3}
HP71CRWM (requires 20 clips)..... \$119.00/ea.

- 1965-68 C-Body (all models)^{OS3}
HP65CFMPM (requires 26 clips)..... \$149.00/ea.

METAL HOOD PAD CLIPS



Reproductions of the original stamped metal hood pad clips for all 1962-65 and 1966-71 models.

- HPCLIP-M62 (1962-65).....\$3.00/ea.
- HPCLIP-M (1966-71).....\$3.00/ea.

PLASTIC HOOD PAD CLIPS



Reproduction plastic hood pad clips for all 1972 and later models.

- HPCLIP-P.....\$1.00/ea.

Chrysler, Dodge, Plymouth

WINDOW SWEEP KITS

Reproduction window sweep kits consist of felt-lined pieces for sealing the side glass to the door or quarter panel. Reproduced as close to original as possible, each kit is model specific and includes the chrome or black metal backing strip. Available in 4 piece kits (outer sweeps only) or complete 6, 8 and 10 piece kits (inner and outer sweeps).



B-BODY MODELS

1962 Dart, 330, 440, Polara & Polara 500

WS62WX12708 (Conv.) (8 pc.)	\$119.00/kit
WS62WX22704 (Conv.) (4 pc.)	\$ 89.00/kit
WS62WX12508 (HTP) (8 pc.)	\$119.00/kit
WS62WX22504 (HTP) (4 pc.)	\$ 89.00/kit
WS62WW12608 (Sedan) (8 pc.)	\$119.00/kit
WS62WW22604 (Sedan) (4 pc.)	\$ 89.00/kit

1962 Savoy, Belvedere, Fury & Sport Fury

WS62WX12708 (Conv.) (8 pc.)	\$119.00/kit
WS62WX22704 (Conv.) (4 pc.)	\$ 89.00/kit
WS62WX12508 (HTP) (8 pc.)	\$119.00/kit
WS62WX22504 (HTP) (4 pc.)	\$ 89.00/kit
WS62WW12608 (Sedan) (8 pc.)	\$119.00/kit
WS62WW22604 (Sedan) (4 pc.)	\$ 89.00/kit

1963 Dodge 440, Polara & Polara 500

WS63WX12908 (HTP) (8 pc.)	\$119.00/kit
WS63WX22904 (HTP) (4 pc.)	\$ 79.00/kit

1963 Belvedere, Fury & Sport Fury

WS63WX12908 (HTP) (8 pc.)	\$119.00/kit
WS63WX22904 (HTP) (4 pc.)	\$ 79.00/kit

1964 Dodge 440, Polara & Polara 500

WS64WX13008 (HTP) (8 pc.)	\$ 99.00/kit
WS64WX23004 (HTP) (4 pc.)	\$ 69.00/kit

1964 Belvedere, Fury & Sport Fury

WS64WX13008 (HTP) (8 pc.)	\$ 99.00/kit
WS64WX23004 (HTP) (4 pc.)	\$ 69.00/kit
☞ Round chrome bead style on inner window sweep.	
WS64WX12810 (HTP) (10 pc.)	\$159.00/kit
WS64WW22804 (HTP) (4 pc.)	\$ 99.00/kit
☞ Flat chrome bead style on inner window sweep.	

1963-64 Dodge 330, 440, Polara & Polara 500

WS63WX13108 (Conv.) (8 pc.)	\$119.00/kit
WS63WX23104 (Conv.) (4 pc.)	\$ 79.00/kit
WS63WW13208 (Sedan) (8 pc.)	\$119.00/kit
WS63WW23204 (Sedan) (4 pc.)	\$ 89.00/kit

1963-64 Savoy, Belvedere, Fury & Sport Fury

WS63WX13108 (Conv.) (8 pc.)	\$119.00/kit
WS63WX23104 (Conv.) (4 pc.)	\$ 79.00/kit
WS63WW13208 (Sedan) (8 pc.)	\$119.00/kit
WS63WW23204 (Sedan) (4 pc.)	\$ 89.00/kit

1965 Coronet & Coronet 500

1965 Belvedere I, Belvedere II & Satellite	
WS63WX13108 (Conv.) (8 pc.)	\$119.00/kit
WS63WX23104 (Conv.) (4 pc.)	\$ 79.00/kit
WS64WX13008 (HTP) (8 pc.)	\$ 99.00/kit
WS64WX23004 (HTP) (4 pc.)	\$ 69.00/kit
WS63WW13208 (Sedan) (8 pc.)	\$119.00/kit
WS63WX23204 (Sedan) (4 pc.)	\$ 79.00/kit

1966-67 Charger

WS66WX10708 (Fastback) (8 pc.)	\$179.00/kit
WS66WX20704 (Fastback) (4 pc.)	\$119.00/kit

1966-67 Coronet & Coronet 500

1966-67 Belvedere I, II, Satellite & GTX	
WS66WW10108 (Conv.) (8 pc.)	\$179.00/kit
WS66WW20104 (Conv.) (4 pc.)	\$119.00/kit
WS66WX10208 (HTP) (8 pc.)	\$179.00/kit
WS66WX20204 (HTP) (4 pc.)	\$119.00/kit
WS66WW11508 (Sedan) (8 pc.)	\$179.00/kit
WS66WW20404 (Sedan) (4 pc.)	\$119.00/kit

1968 Coronet & Coronet 500

WS68WW10408 (Conv.) (8 pc.)	\$179.00/kit
WS68WX24904 (Conv.) (4 pc.)	\$119.00/kit
WS68WX19508 (HTP) (8 pc.)	\$179.00/kit
WS68WX22104 (HTP) (4 pc.)	\$119.00/kit
WS68WX10504 (Sedan) (4 pc.)	\$119.00/kit

1968 Roadrunner, Satellite & GTX

WS68WW10608 (Conv.) (8 pc.)	\$179.00/kit
WS68WX25004 (Conv.) (4 pc.)	\$119.00/kit
WS68WX19608 (HTP) (8 pc.)	\$179.00/kit
WS68WX22004 (HTP) (4 pc.)	\$119.00/kit
WS68WX10504 (Sedan) (4 pc.)	\$119.00/kit

1968-70 Charger (w/ padded upper panels)

WS68WX10808 (HTP) (8 pc.)	\$179.00/kit
WS68WX22204 (HTP) (4 pc.)	\$119.00/kit

1969-70 Coronet & Coronet 500

WS69WW14908 (Conv.) (8 pc.)	\$179.00/kit
WS69WX24904 (Conv.) (4 pc.)	\$119.00/kit
WS68WX19508 (HTP) (8 pc.)	\$179.00/kit
WS68WX22104 (HTP) (4 pc.)	\$119.00/kit
WS68WX10504 (Sedan) (4 pc.)	\$119.00/kit

1969-70 Roadrunner, Satellite & GTX

WS69WW15008 (Conv.) (8 pc.)	\$179.00/kit
WS69WX25004 (Conv.) (4 pc.)	\$119.00/kit
WS68WX19608 (HTP) (8 pc.)	\$179.00/kit
WS68WX22004 (HTP) (4 pc.)	\$119.00/kit
WS68WX10504 (Sedan) (4 pc.)	\$119.00/kit

1971-72 Charger & Charger SE

WS71WW16210 (10 pc.)	\$179.00/kit
WS71WW26204 (4 pc.)	\$119.00/kit
WS72WW16404 ('72 SE only) (4 pc.)	\$119.00/kit

1971-72 Roadrunner, Satellite & GTX

WS71WW16010 (10 pc.)	\$179.00/kit
WS71WW26004 (4 pc.)	\$119.00/kit

1973-74 Roadrunner, Satellite & GTX

WS73WW16110 (10 pc.)	\$179.00/kit
WS73WW26104 (4 pc.)	\$119.00/kit

1973 Charger SE

1973-74 Charger	
WS73WW16310 (10 pc.)	\$179.00/kit
WS73WW26304 (4 pc.)	\$119.00/kit

☞ For Charger SE models without the formal roof and 3-louvered quarter windows.

1973-74 Charger SE

WS73WW16604 (4 pc.)	\$119.00/kit
☞ For Charger SE models with 3-louvered quarter windows.	

C-BODY MODELS

1965-68 Chrysler 300

1965-68 Newport & New Yorker
1965-68 Polara, Polara 500 & Monaco
1965-68 Fury III & Sport Fury

WS65WW27504 (Conv.) (4 pc.)	\$ 99.00/kit
WS65WW27404 (HTP) (4 pc.)	\$ 99.00/kit

1967-68 Chrysler 300

1967-68 Newport & New Yorker
1967-68 Polara, Polara 500 & Monaco
1967-68 Fury III & Sport Fury

WS67WW27604 (Fastop) (4 pc.)	\$119.00/kit
------------------------------	--------------

1969-70 Chrysler 300

1969-70 Newport & New Yorker

WS69WW18008 (Conv.) (8 pc.)	\$179.00/kit
WS69WW28004 (Conv.) (4 pc.)	\$119.00/kit
WS69WW17908 (HTP) (8 pc.)	\$179.00/kit
WS69WW27904 (HTP) (4 pc.)	\$119.00/kit

1969-70 Polara, Polara 500 & Monaco

WS69WW17708 (Conv.) (8 pc.)	\$179.00/kit
WS69WW27704 (Conv.) (4 pc.)	\$119.00/kit
WS69WW17908 (HTP) (8 pc.)	\$179.00/kit
WS69WW27904 (HTP) (4 pc.)	\$119.00/kit

1969-70 Fury III & Sport Fury

WS69WW17708 (Conv.) (8 pc.)	\$179.00/kit
WS69WW27704 (Conv.) (4 pc.)	\$119.00/kit
WS69WW17908 (HTP) (8 pc.)	\$179.00/kit
WS69WW27904 (HTP) (4 pc.)	\$119.00/kit

1971 Chrysler 300, Newport & New Yorker

WS69WW17908 (HTP) (8 pc.)	\$179.00/kit
WS69WW27904 (HTP) (4 pc.)	\$119.00/kit

1971 Polara & Monaco

WS69WW17908 (HTP) (8 pc.)	\$179.00/kit
WS69WW27904 (HTP) (4 pc.)	\$119.00/kit

1971 Fury III & Sport Fury

WS69WW17908 (HTP) (8 pc.)	\$179.00/kit
WS69WW27904 (HTP) (4 pc.)	\$119.00/kit

DODGE TRUCK MODELS

1973-79 Warlock & Lil' Red Express

WS76WX15504 (4 pc.)	\$119.00/kit
---------------------	--------------



TERMS AND CONDITIONS

HOW TO ORDER

MAIL, PHONE OR FAXES – When ordering by mail, please fill in all information on the order form that pertains to your vehicle. Print all information and include a telephone number where you can be reached during the day and evening. When ordering for more than one vehicle, please use separate order forms for each vehicle (see order forms in your Legendary Auto Interiors catalog). When ordering by phone, please have your customer number and a list of items ready. You may order conveniently by phone 8:00AM to 6:00PM EST Monday-Friday. Orders may also be sent in by fax 24 hours a day, 7 days a week. Please note that orders faxed in on Saturday or Sunday will not be received and processed until Monday. FAX: 1-800-732-8874

ON-LINE ORDERING – Legendary Auto Interiors, Ltd also offers convenient and easy on-line ordering 24 hours a day, 7 days a week at www.legendaryautointeriors.com. Click on the “Shop Online” tab in the options menu and follow the ordering procedures. Upon completion, Legendary Auto Interiors, Ltd will follow up with an email confirmation so you can verify that your order has been received correctly and is being processed. You may also choose to email your orders by contacting our sales department at sales@legendaryautointeriors.com.

METHODS OF PAYMENT

CREDIT CARDS – Legendary Auto Interiors, Ltd accepts Visa, MasterCard, American Express and Discover for your convenience. Please include the cardholder’s name, billing address, home and business phone, credit card number, expiration date and the 3 or 4 digit security code when placing your orders. Without this information it may slow the processing of your order.

CHECKS AND MONEY ORDERS – Personal Checks will be held 5 business days. To expedite your orders, we suggest paying by Certified Bank Check or Money Order. COD orders are no longer accepted. All payments MUST be in U.S. funds.

SHIPPING SERVICES

DOMESTIC SHIPPING - Legendary Auto Interiors Ltd utilizes both UPS and FedEx Ground for most U.S. parcel shipments which provides our customers the most efficient and cost effective shipping services available. We will ship by the best method for your geographic area unless otherwise specified. We also offer specialized shipping services such as 3 day Select, 2nd day air and Next Day Air for your convenience.

INTERNATIONAL SERVICES – We use the most current and most cost effective international parcel shipping companies available to provide both “Door to Airport” and “Door to Door” services to our overseas customers. We utilize UPS Canadian and FedEx International for Canadian shipments. This provides us with the best possible shipping and brokerage fees for our international customers.

DAMAGES AND SHORTAGES

The carrier is responsible for any merchandise lost or damaged in transit. **Should a package appear to be damaged, OPEN the package while the carrier’s driver is present and note all damages and/or shortages.** If this is not possible and you discover damaged goods or shortages, contact our Customer Service Department immediately! Damages and/or shortage claims must be made within 5 days of receipt of merchandise to ensure our ability to file a claim with the carrier. Please be sure to check all merchandise when you receive it and again before attempting installation.

Legendary Auto Interiors, Ltd. is committed to providing the highest possible level of customer service, however on rare occasions circumstances beyond our control can result in lost or damaged packages. To protect our customers against delays and having to make time consuming phone calls to the carrier, orders will incur a modest \$2.50 insurance fee on each shipment. In the event any products become lost or damaged we will then send replacement parts as quickly as possible, subject to material availability. We will also file the claims and deal with the carrier.

Carriers allow a short period of time to file claims. To take advantage of this service you must notify Legendary Auto Interiors, Ltd. of any damages within 5 days of receiving your delivery. Failure to contact us within this 5 day window will negate Legendary Auto Interiors further involvement.

RETURN POLICY

Legendary Auto Interiors Ltd. will accept the return of products for a full refund or exchange up to 30 days from the original invoice date with no re-stocking fee. Returns after a 30 day period, but before 60 days will be subject to a 25% restocking fee. No returns will be accepted after 60 days. Custom, Special Orders, Specialty Run Materials, Leather, NOS and carpets ordered in colors other than black are not eligible for return under any circumstances other than a manufacturing defect. If any product is modified, altered, painted, installed or disassembled in any way without Legendary’s expressed written permission, the item is non-returnable. Legendary always recommends professional installation on all products. Any item which has been altered, painted, installed or deemed non-resalable by Legendary will be returned to the customer at the customer’s expense. Legendary is not responsible or liable for labor fees associated with the installation, modification or repair of any product purchased regardless of the circumstances.

RETURN GOOD INFORMATION

All returns must receive prior approval and an RMA (Return Merchandise Authorization) number prior to return shipping. Packages received by Legendary Auto Interiors Ltd. without prior approval and RMA number will be refused. Return shipping and insurance are the customers responsibility. All returned items must be received in as new condition. Examples that render a product non-returnable include, but are not limited to: evidence of attempted installation, parts that have been bent, broken, creased, scratched, soiled, melted or discolored. Also, we will not accept returns for any items that have been altered, painted, repaired or for any reason that has rendered the product non-returnable. Warning: Legendary is not responsible for damaged or lost packages returned by the customer.

CANADIAN CUSTOMER RETURNS

Warranty returns must be clearly marked as follows: **“U.S. GOODS BEING RETURNED FOR REPAIR OR REPLACEMENT UNDER WARRANTY COMMODITY CODE 9801:00V0”**.

PRICES

All prices effective December 31st, 2021 and are subject to change without notice.

HOURS

Monday – Friday 8:00AM to 6:00PM (Eastern Standard Time)

Saturday - By appointment only please

TERMS AND CONDITIONS CONTINUED

WARRANTY INFORMATION

Legendary Auto Interiors, Ltd proudly stands behind all of the products and services we offer. All Legendary manufactured interior soft trim products are backed by an exclusive **Limited Lifetime Warranty** for as long as you own your car. In addition, we offer a 5-year warranty on all of our molded and exterior soft trim products. Legendary Auto Interiors, Ltd also offers a huge selection of interior components, which we warranty for a minimum of 1 year in accordance with the original manufacturers product warranty. **Product Disclaimer: Normal wear from use or problems due to improper installation are excluded from any warranty.**

LEGENDARY GUARANTEE

All Legendary Auto Interiors, Ltd manufactured products are made to original specifications and are guaranteed to fit. In the event that you experience a problem with any of our products or are dissatisfied with our service, we will make every effort to resolve and correct your issue promptly and do our best to make sure that you are completely satisfied.

INTERIOR COLORS/GRAINS

Legendary Auto Interiors, Ltd offers one of the most diverse product lines available in the marketplace. We feature the correct "color matched" and "grain matching" materials for nearly all models and styles. Due to the extensive number of colors produced by Chrysler, AMC and General Motors, there are some colors, which are simply not available in reproduction form. As the demand for colors increases, we are constantly having previously unavailable colors reproduced. In the event that a vinyl or cloth is not available in reproduction form, the use of NOS material may be required. Please inquire for a current quote, as the price and availability of these NOS materials will vary. To ensure a correct color and grain match, your interior trim code may be required for verification. As color dye lots will vary, we recommend purchasing all your soft trim components at the same time to ensure an exact color match of all components throughout your interior. **Color and grain samples are available upon request at no charge.**

LEATHER INTERIORS

Legendary Auto Interiors, Ltd produces a large number of "as original" leather interiors that are color matched to the original. Special order custom leather interiors are also available upon request. Some applications may require a clean, non-faded sample to ensure the closest possible color match. Leather interior orders may require additional lead-time as well as additional costs, which will be quoted at time of your order. **Note: Due to the variable nature of real leather, minor marks and features are normal and add to the character & individuality of leather products.**

CUSTOM ORDERS

In addition to "As Original" reproduction interiors, Legendary Auto Interiors, Ltd specializes in and is proud to feature "CUSTOM" interiors servicing the Resto-Mod enthusiast. With the introduction of our new & exclusive *Legend/Interior* product, custom orders have taken on an entirely new look and have given enthusiasts almost limitless options to create a one of a kind interior. Special Order and Custom interiors require approval for all designated materials being used and a signature approval on a "Custom Order" form is also required. Once the Custom work has been approved these orders must be prepaid and are Non-Returnable, Non-Refundable and Non-Cancelable.

INSTALLATION NOTES

Since age deteriorates certain areas of seats due to wear patterns and foam breakdown, certain adjustments and foam repair may be required to complete a perfect fit installation. For this reason, we recommend having a professional automotive interior trim/upholstery shop install your new Legendary Auto Interiors, Ltd soft trim products. As the manufacturer, we know how to install our products better than anyone and we offer complete installation services for both seat upholstery and door panels. For further information, see the **INSTALLATION GUIDE** included with your seat upholstery and door panels or the installation page of this catalog.

PRODUCT DEVELOPMENT & PATTERNS NEEDED

In an effort to develop new upholstery kits, door panels and other soft trim products we work hand in hand with many of our customers who provide their original parts for product development. These items must be ORIGINAL, in fair to good condition and have not been previously repaired or replaced in any way. Our Sales Department must be contacted directly before sending your old upholstery or other soft trim products to us. Since we have no idea about the usability of your parts until we receive them in, you may initially be asked to send photos in an effort to identify the condition of your original parts. Please remember that even if you send in your parts for inspection, we may not be able to use them. **PLEASE NOTE THAT OLD UPHOLSTERY AND OTHER SOFT TRIM ITEMS CANNOT BE RETURNED TO YOU, AS THEY WILL BE DISMANTLED FOR DEVELOPMENT USE.**

MAINTENANCE

All Legendary Auto Interiors, Ltd products may be cleaned with a mild soap and warm water solution. Never scrub or use any kind of harsh pads, brushes or detergents. After cleaning with mild soap and water, lightly clean again with an industrial grade wax and grease remover. (Contact your local auto parts store) Allow surface to dry. LIGHTLY mist with the vinyl protectant of your choice. Install your new parts into your cruising machine. Sit back, enjoy the ride and drive safely!! Note: On leather upholstery applications we recommend using a high-quality mink oil, neatsfoot oil and/or wax. Hand apply, let stand 30-60 minutes and then wipe /buff clean. LIGHTLY rub your soft trim product with oil and wipe excess oil from the surface. **DO NOT USE SILICONE BASED PRODUCTS** as they will deteriorate the thread and dry out leather.

INSTALLATION SERVICES

GM, CHRYSLER & AMC SEAT UPHOLSTERY

(Includes tear down of original upholstery and installation of new upholstery)



Front Buckets Install - \$500.00/pr.
(No Headrest Covers)



Front Buckets w/ Headrest Covers Install - \$600.00/pr.



Front Split Bench Install - \$575.00/ea.



Front Split Bench w/ Headrest Covers Install - \$675.00/ea.



Rear Bench Seat Install - \$400.00/ea.



Headrest Covers Install - \$150.00/pr.

Center Armrest Install - \$150.00/ea.
(for models w/ buckets and no console)



SAVE ON COMPLETE FRONT & REAR INSTALLS!!

Front Buckets & Rear Bench Seat Install - \$750.00/set

Front Buckets w/ Headrest Covers & Rear Bench Seat Install - \$850.00/set

Front Split Bench & Rear Bench Seat Install - \$825.00/set

Front Split Bench w/ Headrest Covers & Rear Bench Seat Install - \$925.00/set

NOTE* Basic installations DO NOT include new foam and cotton replacement or reconstruction, media blasting, painting, welding, frame straightening, polishing or trim detailing. These services are additional and available at an hourly rate. Please call for more details. **1-800-363-8804*

INSTALLATION SERVICES

GM, CHRYSLER & AMC DOOR PANELS

Basic Door Panel Installation

(Includes installation of metal rails and window weatherstrip)

*Convertible rear panel installation DOES NOT include ashtray/well covers

*Ashtray/well covers for General Motors models are available. Call for details



Front Panels (Pair Only) - \$250.00/pr.



Hardtop/Convertible Rear Panels (Pair Only) - \$250.00/pr.

Complete Front & Rear Panels (Pairs Only) - \$500.00/pr.

Deluxe Door Panel Installation

(Includes installation of metal rails, window weatherstrip, metal trim and decorative emblems)

*Convertible rear panel installation DOES NOT include ashtray/well covers

*Ashtray/well covers for General Motors models are available. Call for details



Front Panels (Pair Only) - \$400.00/pr.



Hardtop/Convertible Rear Panels (Pair Only) - \$325.00/pr.

Complete Front & Rear Panels (Pairs Only) - \$725.00/pr.

DOOR PANEL REFURBISHMENT

If we do not list your particular year/make/model vehicle, Legendary Auto Interiors, Ltd. can refurbish your panels back to original for you. The following refurbishing rates include installation of new panels (on your original metal rails), inner window weatherstripping, metal trim and decorative emblems. Please call for instructions before shipping your door panels.

Front Panels (Pair Only) - \$750.00/pr.

Hardtop/Convertible Rear Panels (Pair Only) - \$500.00/pr.

Complete 2-Door Front & Rear Panels (Pairs Only) - \$1250.00/set

Complete 4-Door Front & Rear Panels (Pairs Only) - \$1250.00/set

NOTE Custom refurbishing does not include the refinishing of metal trim and decorative emblems. We highly recommend this work is done before sending the panels.

SHIPPING/HANDLING RATE CHART

<u>Order Value \$</u>	<u>Flat Rate</u>	<u>Oversize Charges</u>	<u>Rate</u>
.01-40	\$8	OS1	\$21
41-100	\$18	OS2	\$41
101-200	*\$27	OS3	\$59
201-400	*\$34	Insurance	*\$3.50
401-600	*\$39		
601-800	*\$62		
801-1000	*\$90		
1001-1250	*\$109		
1251-1500	*\$137		
1501-1850	*\$172		
1851-2100	*\$206		
2101-2500	*\$235		
2501-2999	*\$265		
3000-up	*\$293		

*Includes \$3.50 for insurance

*On all orders over \$100

*NYS Customers - Sales tax will be added

*AK, HI, PR & International customers call for shipping

*Next Day, 2nd Day & 3 Day Select shipping, please call for rates

Oversize Items Classification

Package Tray	OS1
Trunk Divider	OS1
Plastic Door Panels	OS1
Pre-Assembled Door Panels	OS1
2nd Gen F-Body Door Panels	OS1 
Consoles	OS1
Bucket Molded Foam	OS1
Install Kits 2-5, 12-15	OS1
Vinyl Yardage (1yd & up)	OS1

Oversize Items Classification

Molded Headliners	OS3
Molded Hood Pads	OS3
Pick Up Seat Back Kits	OS3 
GM Bench Seat Foam	OS3
E-Body Dash Pads/Caps	OS3
Trunk Packages	OS3

Oversize Items Classification

C-Body Carpet Kits	OS2
62-65 B Body Mopar Carpet Kits	OS2
Carpet Yardage	OS2 
Sound Dampeners	OS2
Firewall Insulation	OS2
Convertible Glass	OS2

2023 TENTATIVE SHOWS AND DATES

Spring Carlisle
Chryslers @ Carlisle
Fall Carlisle
SEMA

Carlisle, PA
Carlisle, PA
Carlisle, PA
Las Vegas, NV

April 19 - 23, 2023
July 14 - 16, 2023
Sept. 27 - Oct. 1, 2023
Oct. 31 - 3, 2023

Due to the ongoing COVID-19 pandemic the above dates are tentative and are subject to being changed or cancelled. For updates please check our website at www.legendaryautointeriors.com or call us at 1-800-363-8804.

Legendary Auto Interiors Ltd. welcomes the opportunity to support the smaller clubs' and organizations' car shows and swap meets. A variety of flyers, catalogs and gift certificates are available to clubs and organizations who sponsor shows nationwide. Please call or write for additional information. The list above is a tentative schedule subject to change without notice. Come visit us at many car shows/swap meets and see what makes a Legendary interior... truly Legendary.



Legendary
AUTO INTERIORS LTD.

Table of Contents

SEAT UPHOLSTERY & TRIM ACCESORIES A1-A44

Bucket Seat Catch.....	A44	Upholstery (Belvedere I & II).....	A6-A10	Upholstery (Roadrunner).....	A3-A5, A8-A12
Bucket Seat Hinge Washer.....	A42	Upholstery (Charger).....	A13-A22	Upholstery (Sat/Sport Sat).....	A2-A5, A9-A13
Center Armrest Hinge Washer.....	A42	Upholstery (Chrysler 300).....	A32-A38	Upholstery (Savoy).....	A6
Headrest Chrome Bands.....	A44	Upholstery (Coronet).....	A22-A27	Upholstery (Superbee).....	A17, A19, A23-A26
Hinge Covers.....	A42	Upholstery (Daytona).....	A14	Upholstery (Superbird).....	A4
Front Shoulder Harness.....	A44	Upholstery (Dodge 440).....	A28	Upholstery (Superstock).....	A39-A40
Plastic Seatback Covers.....	A42	Upholstery (Fury/Sport Fury).....	A28-A32	Upholstery (Truck).....	A39-A42
Seat Belts.....	A44	Upholstery (GTX).....	A2-A5	Upholstery (Volare).....	A38
Seat Belt Guide.....	A44	Upholstery (Newport).....	A36-A38	Upholstery (Van).....	A39
Seat Belt Mounting Covers.....	A44	Upholstery (Polara).....	A27-A28		
Seat Spacer.....	A44				
Seat Spring Kits.....	A43				
Seat Stops.....	A44				
Seatback Boards.....	A44				
Seatback Top Boards.....	A44				
Seat Latch Return Springs.....	A44				

MOLDED FOAM & FOAM ACCESORIES A45-A48

Cotton Rolls.....	A45
High Density Foam.....	A45
Hog Ring Plier Kits.....	A45
Molded Foam.....	A47-A48
Seat Upholstery Installation Kits.....	A46

DOOR PANELS & TRIM ACCESORIES A49-A69

Armrest Bases.....	A68	Door Panels (Belvedere I & II).....	A51-A54	Door Panels (Polara).....	A66
Armrest Pads.....	A68	Door Panels (Charger).....	A57-A61	Door Panels (Roadrunner).....	A53-A56
Ash Trays.....	A69	Door Panels (Coronet).....	A62-A65	Door Panels (Satellite/Sport Sat).....	A51-A56
Door Handles.....	A69	Door Panels (Daytona).....	A58	Door Panels (Superbee).....	A59-A60, A63-A65
Door Lock Ferrules.....	A69	Door Panels (Fury/Sport Fury).....	A65-A66	Door Panels (Superbird).....	A54
Door Lock Knobs.....	A69	Door Panels (GTX).....	A52-A55	Door Panels (Superstock).....	A67
Door Panel Clips.....	A69				
Map Pocket Emblems.....	A69				
Vent Window Cranks.....	A69				
Window Cranks.....	A69				
Window Crank Screws.....	A69				
Window Crank Spacers.....	A69				

CARPETS, FLOORMATS & ACCESORIES A71-A91

Carpet.....	A75-A76	Jute Backing.....	A75
Carpet Yardage.....	A75	Kick Panels.....	A91
Firewall Insulation.....	A85	Kick Panel Insulation.....	A91
Floormats ("Custom Vintage").....	A81-A83	Sill Plates.....	A91
Floormats (Original).....	A84	Sound Dampening.....	A91
Floormats (Next Generation).....	A86	Sound Deadener.....	A91

DASHES, CONSOLES, SHIFTERS & ACCESORIES A93-A100

4-Speed Console Side Cover.....	A95	Fresh Air Hood Cables.....	A95	Radio Trim Plates.....	A97
Carb Air Applique.....	A95	Glove Box Emblems.....	A98	Rear Window Trim.....	A97
Choke Applique.....	A95	Glove Box Latch.....	A97	Shifter Bezels.....	A100
Consoles.....	A96	Glove Box Liners.....	A98	Shifter Boots.....	A100
Console Carpet Kits.....	A96	HEMI Choke Cable.....	A95	Shifter Knobs.....	A98
Console Shifter Slide.....	A95	Horn Button.....	A97	Underdash Insulation.....	A95
Console Trim.....	A96	Light Lenses.....	A97	Vent Cables.....	A95
Dash Caps.....	A95	Lower Steering Column Cover.....	A95	Woodgrain Console Inserts.....	A96
Dash Pads.....	A94-A95	Pedal Pads.....	A100		
Dash Pad Emblems.....	A95	Pedal Pad Bezels.....	A100		
Dash Vents.....	A97	Pillar Post Moldings.....	A95		
Dash Vent Hose Kits.....	A97	Pistol Grip Shifter & Lens.....	A100		

Table of Contents

HEADLINERS & TRIM ACCESORIES A101-A109

Headliners	A106-A104
Headliner Bow Retaining Clips	A105
Headliner Insulation	A105
Sail Panels	A106
Sunvisors	A108-A109
Sunvisor Tips	A109

PACKAGE TRAY & TRUNK ACCESORIES A111-A116

Package Trays & Jute Insulation ...	A112-A113
Spare Tire Board	A116
Spare Tire Cover	A115
Trunk Dividers & Insulation	A116
Trunk Floor Filler Boards	A116
Trunk Mats	A115
Trunk Mat Material	A115
Trunk Side Panel Covers	A116

VINYL TOPS, CONVERTIBLE TOPS & TRIM A117-A127

Anti Rattle Plates	A124
Convertible Body Screw Studs	A127
Convertible Boots	A126
Convertible Boot Clips	A127
Convertible Tops	A124
Convertible Top Latch	A127
Convertible Top Pads	A124
Convertible Well Liners	A127
Vinyl Tops	A120-A121

WEATHERSTRIPPING & ACCESORIES A129-A136

Accelerator Gaskets	A131	Door Weatherstripping	A132	Pillar Post Weatherstripping	A134
Body Bumper Kits	A130	Door Windlace Weatherstripping	A132	Rear Quarter Window Seals	A133
Body Plug Kits	A130	Door Weatherstripping Clips	A132	Rear Window Gaskets	A132
Conv. Top Frame Weatherstripping	A134	Header Seals	A134	Roof Rail Weatherstripping	A133
Door End Seals	A132	Hood Bumper	A130	Trunk Bumper Kits	A131
Door End/Lock Seal Screw	A132	Hood Bumper Kits	A131	Trunk Seals	A133
Door Handle Gaskets	A131	Hood Pad Clips	A135	Vent Channel Weatherstripping	A134
Door Lock Seals	A132	Hood Pad Insulation	A135	Vent Window Seal	A134
Door & Trunk Lock Gaskets	A131	Hood-to-Cowl Seals	A134	Window Sweep Kits	A136
Door Window Weatherstripping Plug	A131	Hood-to-Radiator Seals	A134	Window Trim Clips	A131
		Molded Hood Pad	A135	Windshield Gaskets	A132



WE'RE NOT JUST CHRYSLER ANYMORE!

1964-72 CHEVELLE/EL CAMINO, GTO/LEMANS, CUTLASS/442 & SKYLARK/GS
1970-72 MONTE CARLO, 1970-72 NOVA & 1967-81 CAMARO & FIREBIRD



WWW.LEGENDARYAUTOINTERIORS.COM

Legendary Auto Interiors, Ltd.
121 West Shore Blvd
Newark, NY 14513



 twitter.com/legendaryautoin

 youtube.com/user/legendaryauto

 facebook.com/legendaryautointeriors

 instagram.com/legendaryautointeriorsltd

LEGENDARY AUTO INTERIORS

1-800-363-8804

WWW.LEGENDARYAUTOINTERIORS.COM