

Skylark
Legendary

AUTO INTERIORS LTD.®

THE FINEST COLLECTION OF INTERIOR AND EXTERIOR PRODUCTS

2023
FIRST
QUARTER



BUICK

**64-72 SKYLARK, GSX &
GRAN SPORT**



www.legendaryautointeriors.com



WE'RE NOT JUST CHRYSLER ANYMORE!

1964-72 CHEVELLE/EL CAMINO, GTO/LEMANS, CUTLASS/442 & SKYLARK/GS
1970-72 MONTE CARLO, 1970-72 NOVA & 1967-81 CAMARO & FIREBIRD



WWW.LEGENDARYAUTOINTERIORS.COM

A Special Message from the President...

For over 3 decades, Legendary Auto Interiors, Ltd has been committed to providing the automotive restoration industry and enthusiast with the world's highest quality soft trim products and services. Available from the most authentic "As Original" interiors to the most extreme "One of a Kind" Custom Resto-Mod interiors, Legendary has been relied upon and Legendary has delivered!

This past decade has been extremely exciting! We continue to set the bar and truly lead by example, establishing industry expectations and standards. Introducing innovative tools such as our exclusive "Custom Design Center", "LegendImagery™" and "Sample Request Center". Whether your preference is "As Original" or a creation of your own vision, we have created a destination where you can let your imagination lead the way! Our commitment to developing and maintaining innovative solutions is a dedicated process that will continue to provide you with great products, service and help grow our restoration industry.

We are looking forward to a very productive future. As owner and President and from all of our proud team here at Legendary Auto Interiors LTD, we would like to thank you for allowing us the opportunity and the privilege of being your automotive soft trim supplier.

Thank you once again for your business, interest and support!

Sincerely yours,

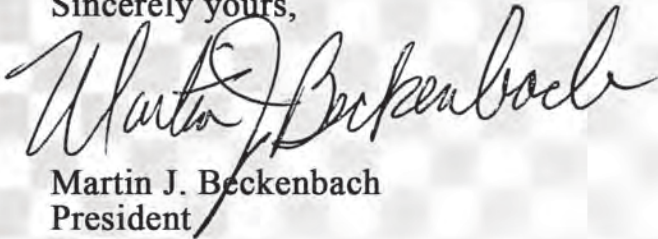

Martin J. Beckenbach
President

PRODUCT DISCLAIMER: Products listed in this catalog have been reproduced and/or remanufactured to resemble original products. All manufacturers names and descriptions are used for reference purposes only. It is therefore understood that the products listed in this catalog are in fact REPRODUCTIONS unless specified otherwise. All parts described and offered for sale in this publication as NOS (New Old Stock) are new parts/materials manufactured by or for Chrysler LLC and General Motors Corporation.

All literature produced by and directly related to Legendary Auto Interiors Ltd., is protected under copyright laws.
All literature cannot be reproduced for any reason unless prior permission is obtained.



ALEX TREAD®

YOU ASK FOR IT...WE DELIVERED!!



PINK COMING
2023!



YOU ASK FOR IT...WE DELIVERED!!

PATENTED

SCENERY MATS

**MANY KOOL SCENES AVAILABLE
AND MORE COMING SOON!**

VERSAFIT™ TRIM-TO-FIT MATS

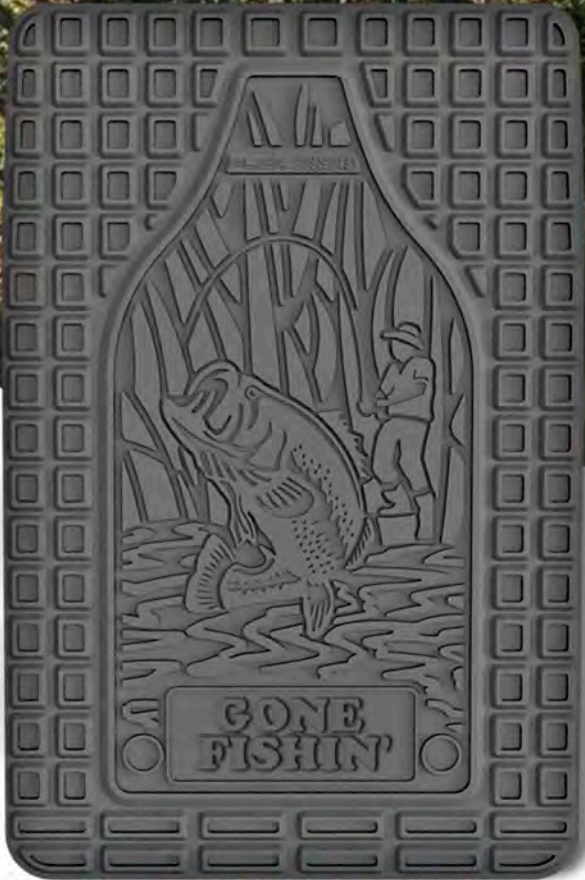

FISHING SCENE

BOOTMATS



DUCK SCENE

SCENERY AVAILABLE ON VERSAFIT™ & BOOTMATS



WHITETAIL SCENE



EQUINE SCENE



**SCORCHED EARTH &
TIRE TRACK SCENE**

Versafit™

Trim-To-Fit Mats

CHOOSE
YOUR
SCENE

VERSAFIT™ universal trim-to-fit floormats fit most domestic and foreign vehicles. Mats can be cut to fit your vehicle's unique floorpan. Includes manual screw in style safety retention positioning posts for installation.



Bootmats

CHOOSE
YOUR
SCENE

"Fun"ctional Boot Mats from FLEXTREAD bring a KOOL look inside while leaving the mess at the door. Featuring scenery and measuring finished size 16" tall by 28" wide.



FLOORMAT & BOOTMAT COLORS



001 - Black

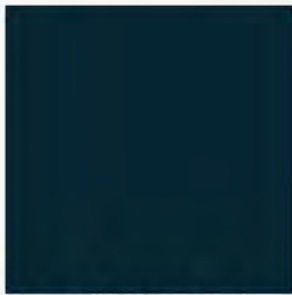

007 - Dark Blue

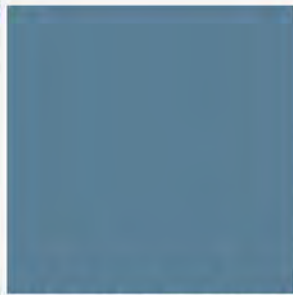

011 - Medium Blue



018 - Bright Red



020 - Red



023 - Tan



031 - Maroon



050 - Turquoise



057 - Dark Olive Green



074 - Pink



079 - Grey



098 - Brown



129 - Dark Saddle



132 - Gold

CAMOUFLAGE



200 - Rugged Woods



202 - Cyberflage

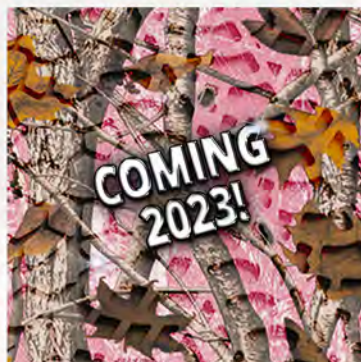

201 - Rugged Woods "Pink"



203 - Cyberflage "Pink"

FLEXTREAD LLC
1-833-700-3539 EXT. 222
WWW.FLEXTREADMATS.COM





Providing the automotive industry
with the world's highest quality
soft trim products and services
RIGHT HERE AT HOME

STILL ASSEMBLED AND
MADE IN THE ★★★★★
USA 

THERE REALLY IS A DIFFERENCE!!

Legendary
AUTO INTERIORS LTD.

www.legendaryautointeriors.com



INTRODUCING THE BEST WARRANTY COVERAGE IN THE INDUSTRY!!

Limited Lifetime Warranty

Limited Warranty - Legendary Auto Interiors Ltd. (called "we") warrants that the products it manufactures will be free of defects in materials and workmanship from the date it is first purchased by the retail purchaser. A retail purchaser is any person or any entity who or which purchases the product but does not do so for resale.

Obligation - If a product is not as warranted, we will either repair or, at our option, replace the defective product. If repair or replacement is not possible within a reasonable time, we will refund the purchase price.

Exclusions from Warranty - This Warranty does not apply to:

1. Conditions resulting from the product being altered, abused, misused, damaged by accident or negligence; being repaired without our authorization; or not being maintained properly in accordance with written instructions provided with the product.
2. Conditions resulting from ordinary wear and tear or including, without limitation, exposure to ultraviolet light.
3. Conditions resulting from the use of Specialty Run Materials (SRM) supplied by the purchaser.
4. Conditions resulting from improper installation by the purchaser or anyone else outside of our control.

Disclaimer - EXCEPT FOR THE LIMITED WARRANTY DESCRIBED ABOVE, WE OFFER NO WARRANTIES, EXPRESSED OR IMPLIED, AND OTHER THAN THE LIMITED WARRANTY EXPRESSLY CONTAINED HEREIN, WE HEREBY DISCLAIM ANY AND ALL WARRANTIES, INCLUDING WITHOUT LIMITATION ANY IMPLIED WARRANTIES OF MERCHANTABILITY, SUITABILITY OR FITNESS FOR A PARTICULAR PURPOSE. Some states do not allow limitations on how long an implied warranty lasts, so the above limitation may not apply to you.

Exclusion of Incidental and Consequential Damages - WE ARE NOT RESPONSIBLE FOR ANY INCIDENTAL OR CONSEQUENTIAL DAMAGES RESULTING FROM BREACH OF THE LIMITED WARRANTY DESCRIBED ABOVE. Some states do not allow the exclusion or limitation of incidental or consequential damages, so the above limitation or exclusion may not apply to you.

Other Legal Rights - This Warranty gives you specific legal rights, and you may also have other rights which vary from state to state.

What To Do If You Have A Warranty Claim - If you have a warranty claim, you must call our sales office for further assistance. Once given a return authorization number please indicate the number on the box and return the product to our facility; Legendary Auto Interiors 121 West Shore Blvd, Newark, NY 14513. We will perform our warranty obligation within a reasonable amount of time after the returned product arrives at our facility.



PRODUCT DISCLAIMER: Products listed in this catalog have been reproduced and/or remanufactured to resemble original products. All manufacturers names and descriptions are used for reference purposes only. It is therefore understood that the products listed in this catalog are in fact REPRODUCTIONS unless specified otherwise. All parts described and offered for sale in this publication as NOS (New Old Stock) are new parts/materials manufactured by or for Chrysler Group LLC and General Motors Corporation.

LEGENDARY AUTO INTERIORS LTD., COPYRIGHT 2022

All literature produced by and directly related to Legendary Auto Interiors Ltd., is protected under copyright laws.
All literature cannot be reproduced for any reason unless prior permission is obtained.

Vinyl Grain Chart



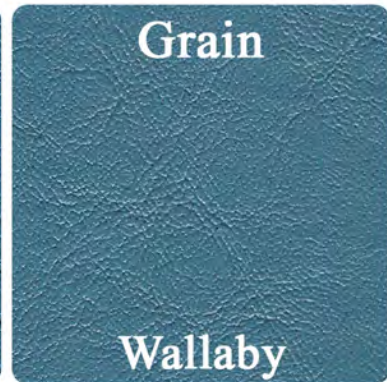
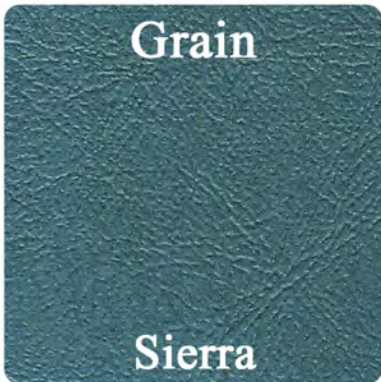
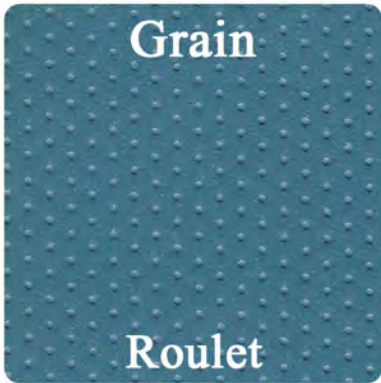
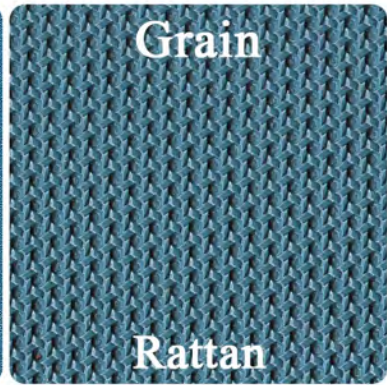
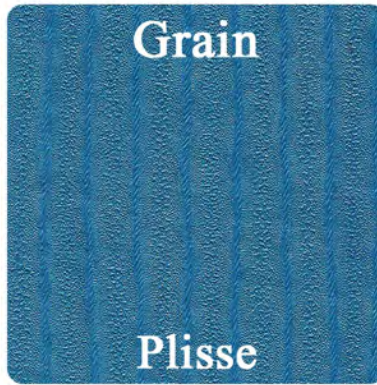

Vinyl Grain Chart





Vinyl Yardage

The following grains are available off the roll and come in 1/2 yard increments **ONLY**

Ascot
 VVYDASCOT(C) (1 Yard).....\$64.00/yd. 
 VV1/2YDASCOT(C) (1/2 Yard).....\$32.00/ea.
 Available colors: 100

Bison
 VVYDBISON(C) (1 Yard).....\$64.00/yd. 
 VV1/2YDBISON(C) (1/2 Yard).....\$32.00/ea.
 Available colors: 100, 204, 314, 510, 606, 610

Coachman
 VVYDCOACHMAN(C) (1 Yard).....\$64.00/yd. 
 VV1/2YDCOACHMAN(C) (1/2 Yard).....\$32.00/ea.
 Available colors: 100, 130, 140, 200, 330, 338,
 340, 432, 434, 452, 528, 540, 550, 560, 640, 650,
 656, 664, 666, 670

Cologne
 VVYDCOLOGNE(C) (1 Yard).....\$64.00/yd. 
 VV1/2YDCOLOGNE(C) (1/2 Yard).....\$32.00/ea.
 Available colors: 100, 102, 10A, 202, 318, 320,
 332, 414, 420, 430, 520, 526, 614, 620, 636

Doeskin
 VVYDDOESKIN(C) (1 Yard).....\$64.00/yd. 
 VV1/2YDDOESKIN(C) (1/2 Yard).....\$32.00/ea.
 Available colors: 100, 104, 200, 206G, 508G

Dorchester
 VVYDDORCHESTER(C) (1 Yard).....\$64.00/yd. 
 VV1/2YDDORCHESTER(C) (1/2 Yard).....\$32.00/ea.
 Available colors: 100, 202

El Paso
 VVYDELPASO(C) (1 Yard).....\$64.00/yd. 
 VV1/2YDELPASO(C) (1/2 Yard).....\$32.00/ea.
 Available colors: 100, 200

Krinkle
 VVYDKRINKLE(C) (1 Yard).....\$64.00/yd. 
 VV1/2YDKRINKLE(C) (1/2 Yard).....\$32.00/ea.
 Available colors: 100, 154

Madrid
 VVYDMADRID(C) (1 Yard).....\$64.00/yd. 
 VV1/2YDMADRID(C) (1/2 Yard).....\$32.00/ea.
 Available colors: 100G, 202G, 204G, 210G, 220G,
 230G, 235G, 239G, 240G, 310G, 325G, 331G, 333G,
 334G, 338G, 342G, 343G, 351G, 369G, 380G, 415G,
 420G, 421G, 424G, 429G, 448G, 460G, 465G, 469G,
 501G, 511G, 513G, 520G, 631G, 635G, 640G, 642G,
 645G, 650G, 651G, 657G, 658G, 670G, 679G, 683G,
 690G, 694G, 695G, 697G, 709G, 710G

Oxen
 VVYDOXEN(C) (1 Yard).....\$64.00/yd. 
 VV1/2YDOXEN(C) (1/2 Yard).....\$32.00/ea.
 Available colors: 100

Oxford
 VVYDOXFORD(C) (1 Yard).....\$64.00/yd. 
 VV1/2YDOXFORD(C) (1/2 Yard).....\$32.00/ea.
 Available colors: 100, 200, 264, 360, 450

Ranger
 VVYDRANGER(C) (1 Yard).....\$64.00/yd. 
 VV1/2YDRANGER(C) (1/2 Yard).....\$32.00/ea.
 Available colors: 100, 200

Shallow Elk
 VVYDSHALLOWELK(C) (1 Yard).....\$64.00/yd. 
 VV1/2YDSHALLOWELK(C) (1/2 Yard).....\$32.00/ea.
 Available colors: 100, 156, 200, 202G, 230G, 341

Sierra
 VVYDSIERRA(C) (1 Yard).....\$64.00/yd. 
 VV1/2YDSIERRA(C) (1/2 Yard).....\$32.00/ea.
 Available colors: 100G, 102G, 200G, 209G, 319G,
 528G, 684G, 688G

1 YARD AND MORE IS SHIPPED OVERSIZED 1

Specialty Grain Vinyl Yardage



All grain/color combinations not listed above can be produced upon request.
 Available in 1/2 yd or 1yd sheets **ONLY**

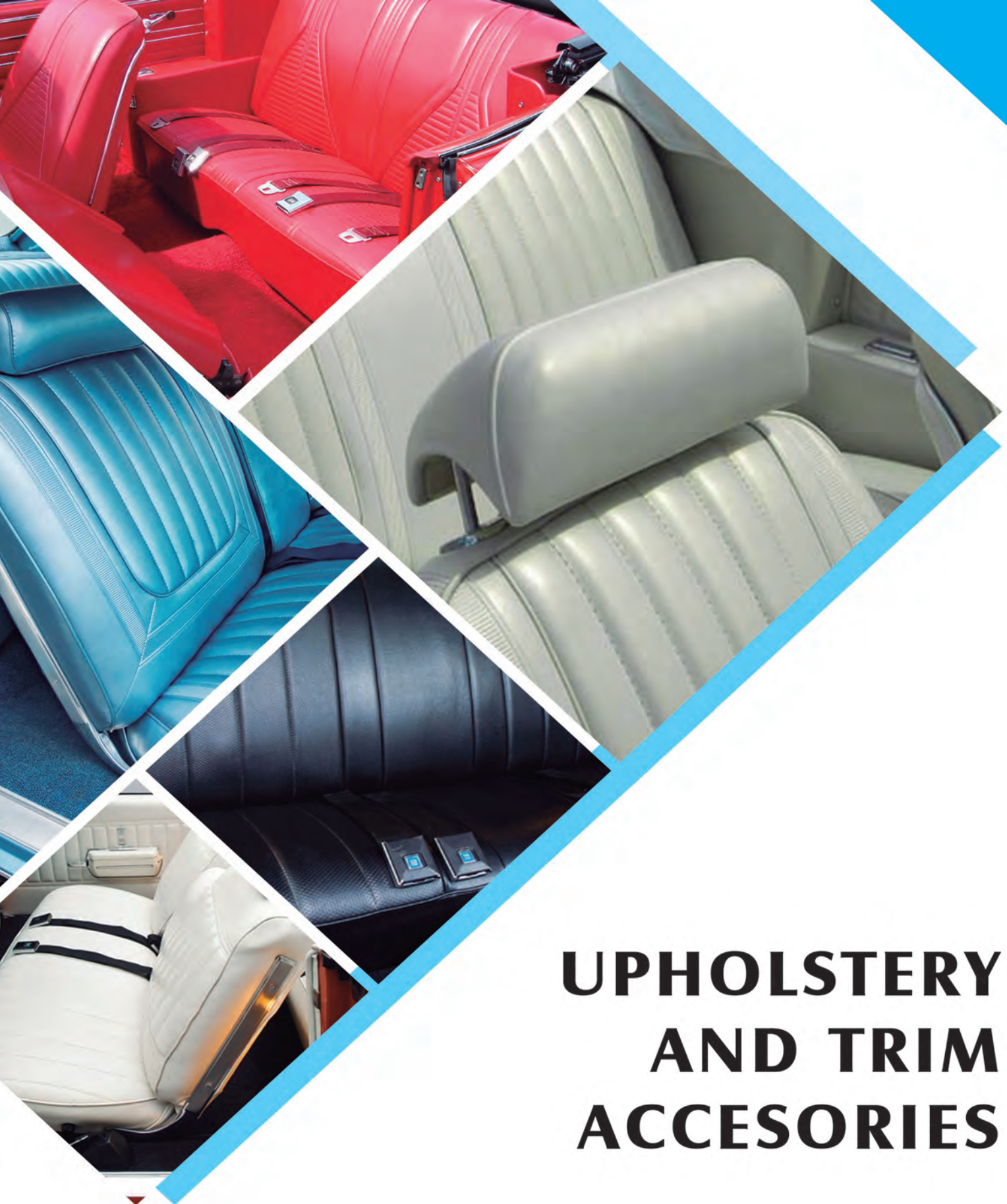

1/2 Yard (54"x18")
 TTMOLDSMALL.....\$36.00/ea.
 * Need to specify grain and color

1 Yard (54"x36")
 TTMOLDXL.....\$96.00/ea. 
 * Need to specify grain and color



UPHOLSTERY AND TRIM ACCESORIES

 facebook.com/legendaryautointeriors
 twitter.com/legendaryautoin

 www.legendaryautointeriors.com
 instagram.com/legendaryautointeriorsltd
 youtube.com/user/legendaryauto

1964 SKYLARK

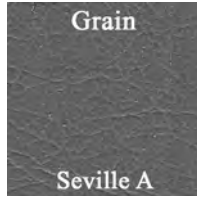

Grain

Seville A

(C) COLOR CODES:

- (100G) Black
- (220G) Frost White
- (334G) Dark Metallic Blue
- (405G) Metallic Green
- (508G) Red
- (656G) Brown

This Legendary product features as-original heat sealed Seville grain inserts and Seville grain skirts with buttons.

Front Buckets	AA64GK00010(C)
100G, 220G, 334G,	
508G, 656G	\$629/pr.
405G	\$1222/pr. (L1)
☞ Molded foam is available for this model.	
Please see the "GM Molded Foam" section in this catalog.	
☞ 405G Metallic Green uses Special Run Material.	
Rear Bench	
Sport Coupe	AA64GK00048(C)
Convertible	AA64GK00056(C)
100G, 220G, 334G,	
508G, 656G	\$358/ea.
405G	\$965/ea. (L1)
☞ 334G Dark Metallic Blue was not offered on a bucket seat interior trim style for a Convertible model in 1964.	
☞ 405G Metallic Green uses Special Run Material.	
Convertible Rear Bench Back Panel	
.....	SK64GA00019(C)
100G, 220G, 334G,	
508G, 656G	\$ 75/ea.
405G	\$235/ea. (L1)
☞ 405G Metallic Green uses Special Run Material.	

1965 SKYLARK & GRAN SPORT

PHOTO N/A
AT TIME OF
PRINTING

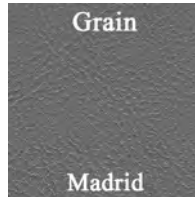

Grain

Madrid

(C) COLOR CODES:

- (100G) Black
- (315G) Light Metallic Blue / Dark Metallic Blue
- (516G) Metallic Red / Dark Metallic Red
- (686G) Saddle / Metallic Brown

This Legendary product features as-original Madrid grain inserts and Madrid grain skirts with buttons.

Front Buckets	AA65GKN0010(C)
100G, 315G, 516G.....	\$569/pr.
686G	\$1222/pr. (L1)
☞ Molded foam is available for this model.	
Please see the "GM Molded Foam" section in this catalog.	
☞ 686G Metallic Green uses Special Run Material.	
Rear Bench	
Coupe	AA65GKN0040(C)
100G, 315G, 516G	\$339/ea.
686G	\$965/ea. (L1)
☞ 686G Metallic Green uses Special Run Material..	

1965 SKYLARK & GRAN SPORT

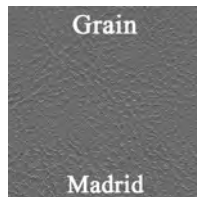

Grain

Madrid

(C) COLOR CODES:

- (100G) Black
- (220G) Frost White
- (343G) Dark Metallic Blue
- (520G) Metallic Red
- (679G) Saddle

This Legendary product features as-original Madrid grain inserts and Madrid grain skirts with buttons.

Front Buckets	AA65GK00010(C)
100G, 220G,	
343G, 520G	\$629/pr.
679G	\$1222/pr. (L1)
☞ Molded foam is available for this model.	
Please see the "GM Molded Foam" section in this catalog.	
Rear Bench	
Sport Coupe	AA65GK00040(C)
Convertible	AA65GK00056(C)
100G, 220G	
343G, 520G	\$358/ea.
679G	\$965/ea. (L1)
☞ 100G Black was not offered on a bucket seat interior trim style for a Sport Coupe model in 1965.	
☞ 343G Dark Metallic Blue was not offered on a bucket seat interior trim style for a Convertible model in 1965.	
Convertible Rear Bench Back Panel	
.....	SK65GA00019(C)
100G, 220G, 343G, 520G	\$75/ea.
679G	\$235/ea.



1966 SKYLARK & GRAN SPORT "OEM STYLE"



(C) COLOR CODES:
 (100G) Black
 (240G) Metallic Parchment
 (330G) Light Metallic Blue w/ Dark Metallic Blue Accent
 (518G) Metallic Red w/ Dark Metallic Red Accent

This Legendary product features as-original heat sealed Madrid grain inserts and Madrid grain skirts with double beaded welt and accent bands.

Front Buckets **AA66GK00010(C)**
 (All Colors) \$547/pr.
 ☞ Molded foam is available for this model. Please see the "GM Molded Foam" section in this catalog.

Rear Bench
 Coupe & Sport Coupe **AA66GK00048(C)**
 Convertible **AA66GK00056(C)**
 (All Colors) \$308/ea.
 ☞ 518G Metallic Red w/ Dark Metallic Red accents was not offered on a bucket seat interior trim style for a Coupe model in 1966.

Headrest Covers..... **HC66GA00N14(C)**
 (All Colors).....\$78/pr.
 ☞ Non-original replacement covers for factory molded headrests.
 ☞ Professional installation is highly recommended.

Convertible Rear Bench Back Panel
 **SK65GA00019(C)**
 (All Colors).....\$75/ea.

1966 SKYLARK & GRAN SPORT RALLYE SEAT



(C) COLOR CODES:
 (100G) Black
 (240G) Metallic Parchment
 (330G) Light Metallic Blue w/ Dark Metallic Blue Accent
 (518G) Metallic Red w/ Dark Metallic Red Accent

This Legendary product features as-original heat sealed Madrid grain inserts and Madrid grain skirts with double beaded welt and accent bands.

Front Buckets **RS66GK00010(C)** ⁰⁵²
 (All Colors) \$954/kit
 ☞ Kit consists of: 1 pair Rallye Bucket Seat Covers, 1 set Rallye Seat Foam (4 pc.), 1 pair Stretch Panel Boards, 1 yd. Muslin, 30 ft. Listing Wire, 2 yd. Burlap, 9 ft. 2 inch Felt and 1 Dust Mask.

Headrest Covers..... **HC66GA00N14(C)**
 (All Colors).....\$78/pr.
 ☞ Non-original replacement covers for factory molded headrests.
 ☞ Professional installation is highly recommended.

1967 SKYLARK & GRAN SPORT "OEM STYLE"



(C) COLOR CODES:
 (100G) Black
 (240G) Metallic Parchment (Requires Sample Approval)
 (343G) Dark Metallic Blue
 (448G) Dark Metallic Turquoise
 (501G) Red
 (640G) Pearl Yellow
 *240G not available for convertible models

This Legendary product features as-original heat sealed Madrid grain inserts and Madrid grain skirts.

Front Buckets **AA67GK00010(C)**
 (All Colors) \$547/pr.
 ☞ Molded foam is available for this model.
 Please see the "GM Molded Foam" section in this catalog.

Rear Bench
 Coupe & Sport Coupe **AA67GK00048(C)**
 Convertible **AA67GK00056(C)**
 (All Colors) \$308/ea.
 ☞ 448G Dark Metallic Turquoise was not offered on a bucket seat interior trim style for a Convertible model in 1967.

Headrest Covers..... **HC66GA00N14(C)**
 (All Colors).....\$78/pr.
 ☞ Non-original replacement covers for factory molded headrests.
 ☞ Professional installation is highly recommended.

Convertible Rear Bench Back Panel
 **SK65GA00019(C)**
 (All Colors).....\$75/ea.

1967 SKYLARK & GRAN SPORT RALLYE SEAT

PHOTO N/A
AT TIME OF
PRINTING

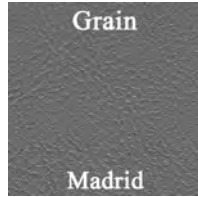

- (C) COLOR CODES:**
 (100G) Black
 (240G) Metallic Parchment (Requires Sample Approval)
 (343G) Dark Metallic Blue
 (448G) Dark Metallic Turquoise
 (501G) Red
 (640G) Pearl Yellow

Front Buckets **RS67GK00010(C)** ^{OS2}
 (All Colors) \$954/kit
 ☞ Kit consists of: 1 pair Rallye Bucket Seat Covers, 1 set Rallye Seat Foam (4 pc.), 1 pair Stretch Panel Boards, 1 yd. Muslin, 30 ft. Listing Wire, 2 yd. Burlap, 9 ft. 2 inch Felt and 1 Dust Mask.

Headrest Covers..... **HC66GA00N14(C)**
 (All Colors)..... \$78/pr.
 ☞ Non-original replacement covers for factory molded headrests.
 ☞ Professional installation is highly recommended.

This Legendary product features as-original heat sealed Madrid grain inserts and Madrid grain skirts.

1968 SKYLARK CUSTOM, GRAN SPORT 350 & 400 "OEM STYLE"

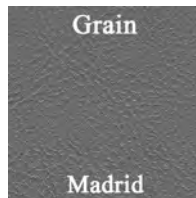

- (C) COLOR CODES:**
 (100G) Black
 (135G) NOS Platinum (Requires Sample Approval)
 (220G) Frost White
 (333G) Teal Blue
 (709G) Buckskin

Front Buckets **AA68GKD0010(C)**
 100G, 220G, 333G, 709G \$547/pr.
 135G..... \$1134/pr. (L1)

☞ Molded foam is available for this model. Please see the "GM Molded Foam" section in this catalog.
 ☞ Customer must reuse original metal buttons.

Rear Bench
 Sport Coupe **AA68GKD0048(C)**
 Convertible **AA68GKD0056(C)**
 100G, 220G, 333G, 709G \$340/ea.
 135G..... \$889/ea. (L1)

☞ 135G Platinum and 709G Buckskin were not offered on a bucket seat interior trim style for a Convertible model in 1968.
 ☞ Customer must reuse original metal buttons.

This Legendary product features as-original Heat Sealed Madrid grain inserts and Madrid grain skirts

1968 SKYLARK CUSTOM, GRAN SPORT 350 & 400 RALLYE SEAT

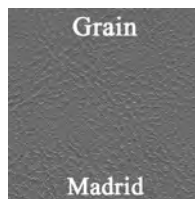

- (C) COLOR CODES:**
 (100G) Black
 (135G) NOS Platinum (Requires Sample Approval)
 (220G) Frost White
 (333G) Teal Blue
 (709G) Buckskin

Front Buckets **RS68GKD0010(C)** ^{OS2}
 100G, 220G, 333G, 709G... \$954/kit
 135G..... \$1194/kit (L1)
 ☞ Kit consists of: 1 pair Rallye Bucket Seat Covers, 1 set Rallye Seat Foam (4 pc.), 1 pair Stretch Panel Boards, 1 yd. Muslin, 30 ft. Listing Wire, 2 yd. Burlap, 9 ft. 2 inch Felt and 1 Dust Mask.

This Legendary product features as-original Heat Sealed Madrid grain inserts and Madrid grain skirts



1969 SKYLARK CUSTOM, GRAN SPORT 350 & 400 "OEM STYLE"

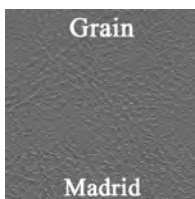

(C) COLOR CODES:
 (100G) Black
 (239G) Metallic Parchment
 (325G) Metallic Blue
 (503G) Red
 (710G) Buckskin

This Legendary product features as-original heat sealed Madrid grain inserts and Madrid grain skirts with heat sealed collars.

Front Buckets**AA69GKD0010(C)**
 (All Colors).....\$547/pr.
 ☞ Molded foam is available for this model.
 Please see the "GM Molded Foam" section in this catalog.

Rear Bench
 Sport Coupe**AA69GKD0048(C)**
 Convertible**AA69GKD0056(C)**
 (All Colors).....\$308/ea.
 ☞ 325G Metallic Blue and 710G Buckskin were not offered on a bucket seat interior trim style for a Convertible model in 1969.
 ☞ 503G Red was not offered in a Coupe model in 1969.

Headrest Covers.....**HC69GA00014(C)**
 (All Colors).....\$78/pr.
 ☞ Non-original replacement covers for factory molded headrests.
 ☞ Professional installation is highly recommended.

1969 SKYLARK CUSTOM, GRAN SPORT 350 & 400 RALLYE SEAT



(C) COLOR CODES:
 (100G) Black
 (239G) Metallic Parchment
 (325G) Metallic Blue
 (503G) Red
 (710G) Buckskin

This Legendary product features as-original heat sealed Madrid grain inserts and Madrid grain skirts with heat sealed collars.

Front Buckets**RS69GKD0010(C)** 
 (All Colors).....\$954/kit
 ☞ Kit consists of: 1 pair Rallye Bucket Seat Covers, 1 set Rallye Seat Foam (4 pc.), 1 pair Stretch Panel Boards, 1 yd. Muslin, 30 ft. Listing Wire, 2 yd. Burlap, 9 ft. 2 inch Felt and 1 Dust Mask.

1970 SKYLARK CUSTOM, GS & GS455 "OEM STYLE"

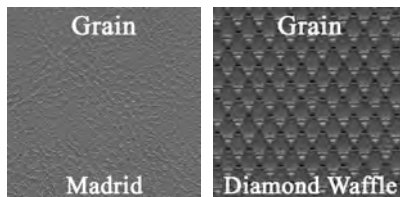

(C) COLOR CODES:
 (100G) Black
 (202G) Pearl White
 (342G) Dark Metallic Blue
 (658G) Burnished Saddle

This Legendary product features as-original Diamond Waffle grain inserts and Madrid grain skirts.

Front Buckets**AA70GK00010(C)**
 (All Colors)..... \$547/pr.
 ☞ Molded foam is available for this model.
 Please see the "GM Molded Foam" section in this catalog.

Rear Bench
 Sport Coupe**AA70GKD0048(C)**
 Convertible**AA70GKD0056(C)**
 (All Colors).....\$308/ea.
 ☞ 342G Dark Metallic Blue was not offered on a bucket seat interior trim style for a Convertible model in 1970. Convertible option originally offered on GS455 Models only.

Headrest Covers.....**HC69GA00014(C)**
 (All Colors).....\$78/pr.
 ☞ Non-original replacement covers for factory molded headrests.
 ☞ Professional installation is highly recommended.

1970 SKYLARK CUSTOM, GS & GS455 RALLYE SEAT



NEW!!!

Front Buckets **RS70GK00010(C)** 
 (All Colors) \$954/kit
 Kit consists of: 1 pair Rallye Bucket Seat Covers,
 1 set Rallye Seat Foam (4 pc.), 1 pair Stretch Panel
 Boards, 1 yd. Muslin, 30 ft. Listing Wire, 2 yd. Burlap, 9
 ft. 2 inch Felt and 1 Dust Mask.



(C) COLOR CODES:
 (100G) Black
 (202G) Pearl White
 (342G) Dark Metallic Blue
 (658G) Burnished Saddle

This Legendary product features as-original Diamond Waffle grain inserts and Madrid grain skirts.

1971 SKYLARK, SKYLARK CUSTOM & GRAN SPORT "OEM STYLE"

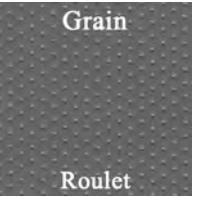

(C) COLOR CODES:
 (100G) Black
 (202G) Pearl White
 (690G) Saddle (1971)

Front Buckets **AA71GK00010(C)**
 (All Colors) \$558/pr.
 Molded foam is available for this model.
 Please see the "GM Molded Foam" section in
 this catalog.

Sport Coupe Rear **AA71GK00048(C)**
 \$320/ea.

Headrest Covers..... **HC69GA00014(C)**
 (All Colors).....\$78/pr.
 Non-original replacement covers for factory molded
 headrests.
 Professional installation is highly recommended.

This Legendary product features as-original Roulet grain inserts with accent belt and Madrid grain skirts

1971-72 SKYLARK, SKYLARK CUSTOM & GRAN SPORT RALLYE SEAT



NEW!!!

Front Buckets **RS71GK00010(C)** 
 (All Colors) \$971/kit
 Kit consists of: 1 pair Rallye Bucket Seat Covers,
 1 set Rallye Seat Foam (4 pc.), 1 pair Stretch
 Panel Boards, 1 yd. Muslin, 30 ft. Listing Wire, 2
 yd. Burlap, 9 ft. 2 inch Felt and 1 Dust Mask.

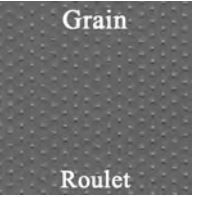

(C) COLOR CODES:
 (100G) Black
 (202G) Pearl White (1971)
 (230G) White (1972)
 (670G) Tan (1972)
 (690G) Saddle (1971)

This Legendary product features as-original Roulet grain inserts with accent belt and Madrid grain skirts



1972 SKYLARK, SKYLARK CUSTOM & GRAN SPORT "OEM STYLE"



(C) COLOR CODES:

- (100G) Black
- (230G) White
- (670G) Tan

Front Buckets**AA71GK00010(C)**
 (All Colors)\$558/pr.
 ☞ Molded foam is available for this model.
 Please see the "GM Molded Foam" section in
 this catalog.

Sport Coupe Rear**AA72GK00048(C)**
\$320/ea.

Headrest Covers.....**HC69GA00014(C)**
 (All Colors).....\$78/pr.
 ☞ Non-original replacement covers for factory molded
 headrests.
 ☞ Professional installation is highly recommended.

*This Legendary product features as-original Roulet grain inserts with accent belt
 and Madrid grain skirts*

**Seat Upholstery Installation Kits Are Available
 To Help Complete Your Install!!**

Seat upholstery Installation Kits from Legendary give
 you the products you need to do the job yourself!! All
 components are upholstery grade and have been hand
 selected by our team of installation experts to provide
 the highest quality materials available.



**Check Out the Installation Kits
 Section For More Information**

***Right After Seat Upholstery Section**

1973-74 RIVIERA

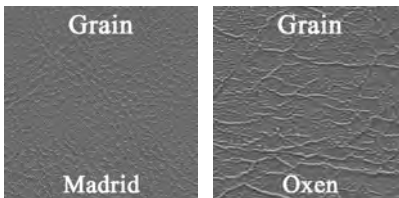

1973 (C) COLOR CODES:

- (100G) Black
- (230G) White
- (678G) Saddle

1974 (C) COLOR CODES:

- (230G) White
- (525G) Burgundy
- (672G) Saddle

1973 Front Buckets**AA73GR00010(C)**
 (All Colors)\$670/pr.
 ☞ Please specify cut pile carpet color at time of
 order.

1973 Hardtop Coupe Rear
**AA73GR00040(C)**
 (All Colors).....\$439/ea.

1974 Front Buckets
**AA73GR00010(C)**
 (All Colors)\$670/pr.
 ☞ Please specify cut pile carpet color at time of
 order.

1974 Hardtop Coupe Rear
**AA73GR00040(C)**
 (All Colors).....\$439/ea.

*This Legendary product features as-original Oxen grain inserts
 and lower back panel with Madrid grain skirts and cut pile stretch panel*

1964 SKYLARK

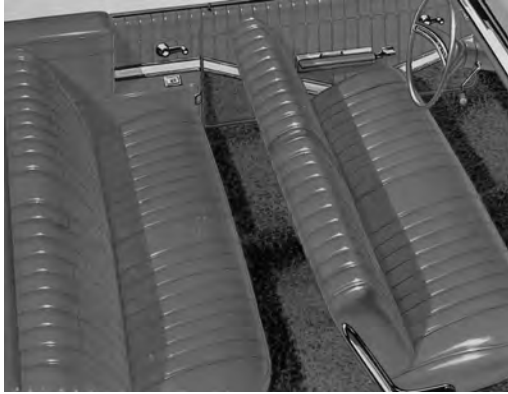

(C) COLOR CODES:
 (325G) Light Metallic Blue
 (508G) Red

Front Split Bench.....	AA64GK00026(C)
(All Colors).....	\$599/ea.
Convertible Rear	
.....	AA64GK00056(C)
(All Colors).....	\$358/ea.
Convertible Rear Bench Back Panel	
.....	SK64GA00019(C)
(All Colors).....	\$75/ea.

This Legendary product features as-original heat sealed Seville grain inserts and Seville grain skirts with buttons.

1965 SKYLARK

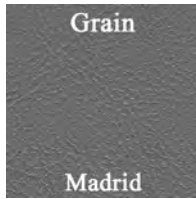
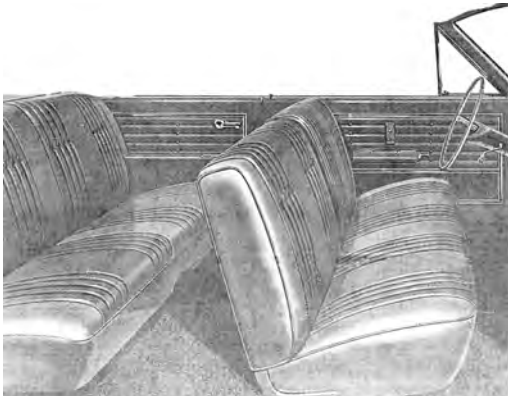

(C) COLOR CODES:
 (100G) Black
 (325G) Light Metallic Blue
 (520G) Metallic Red

Front Split Bench.....	AA65GK00026(C)
(All Colors).....	\$599/ea.
Convertible Rear	
.....	AA65GK00056(C)
(All Colors).....	\$358/ea.
Convertible Rear Bench Back Panel	
.....	SK65GA00019(C)
(All Colors).....	\$75/ea.

This Legendary product features as-original Madrid grain inserts and Madrid grain skirts with buttons.

1966 SKYLARK

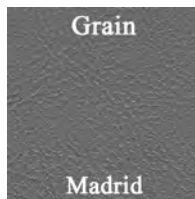

(C) COLOR CODES:
 (100G) Black
 (240G) Metallic Parchment

Front Split Bench.....	AA66GK00020(C)
(All Colors).....	\$558/ea.
Convertible Rear	
.....	AA66GK00056(C)
(All Colors).....	\$308/ea.
Headrest Covers.....	HC66GA00014(C)
(All Colors).....	\$78/pr.
Headrest Covers (Zippered)...	HC66GA00Z14(C)
(All Colors).....	\$97/pr.
Convertible Rear Bench Back Panel	
.....	SK66GA00019(C)
(All Colors).....	\$75/ea.

This Legendary product features as-original Madrid grain inserts and Madrid grain skirts with double beaded welt and accent bands.



1966 SPECIAL DELUXE, SKYLARK & GRAN SPORT

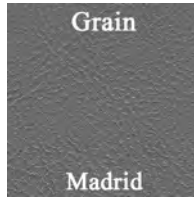

- (C) COLOR CODES:**
 (100G) Black
 (240G) Metallic Parchment
 (330G) Light Metallic Blue w/
 Dark Metallic Blue Accent
 (485G) NOS Light Metallic Aqua w/
 Dark Metallic Aqua Accent
 (518G) Metallic Red w/
 Dark Metallic Red Accent

- (C) HEADREST & REAR BACK
 PANEL COLOR CODES:**
 (100G) Black
 (240G) Metallic Parchment
 (325G) Light Metallic Blue
 (420G) NOS Light Metallic Aqua
 (520G) Metallic Red

This Legendary product features as-original Madrid grain inserts and Madrid grain skirts with double beaded welt and accent bands.

- Front Split Bench with Center Armrest
 **AA66GK00030(C)**
 100G, 240G, 330G, 518G \$558/ea.
 485G \$1125/ea. (L1)
- Rear Bench
 Coupe & Sport Coupe **AA66GK00048(C)**
 Convertible **AA66GK00056(C)**
 100G, 240G, 330G, 518G \$308/ea.
 485G \$868/ea. (L1)
 *240G Metallic Parchment and 485G Light Metallic Aqua w/ Dark Metallic Aqua accents were not offered on a split bench seat with center armrest interior trim style for Convertible models in 1966.
- Headrest Covers
 **HC66GA00014(C)**
 100G, 240G, 325G, 520G \$78/pr.
 420G \$153/pr. (L1)
- Headrest Covers (Zippered) **HC66GA00Z14(C)**
 100G, 240G, 325G, 520G \$97/pr.
 420G \$175/pr. (L1)
- Convertible Rear Bench Back Panel
 **SK65GA00019(C)**
 100G, 240G, 325G, 520G \$75/ea.
 420G \$235/ea (L1)

1967 SKYLARK & GRAN SPORT

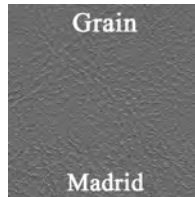

- (C) COLOR CODES:**
 (100G) Black
 (240G) Metallic Parchment
 (Requires Sample Approval)
 *240G not available for convertible models

This Legendary product features as-original heat sealed Madrid grain inserts and Madrid grain skirts.

- Front Split Bench **AA67GK00020(C)**
 (All Colors) \$547/ea.
- Coupe & Sport Coupe Rear...
 **AA67GK00048(C)**
 (All Colors) \$308/ea.
- Convertible Rear Bench
 **AA67GK00056(C)**
 (All Colors) \$308/ea.
- Headrest Covers **HC66GA00014(C)**
 (All Colors) \$78/pr.
 Headrest Covers (Zippered) ... **HC66GA00Z14(C)**
 (All Colors) \$97/pr.
- Convertible Rear Bench Back Panel
 **SK65GA00019(C)**
 (All Colors) \$75/ea.

**1967 SKYLARK
 CLOTH STYLE**

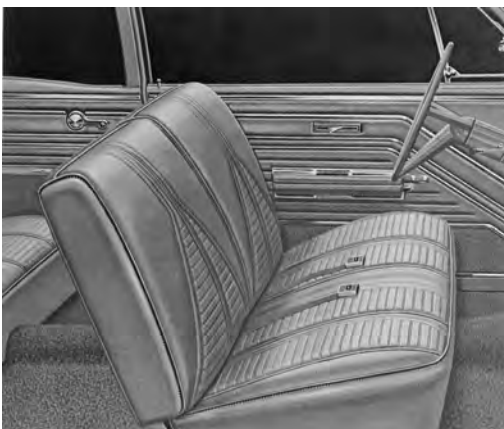

- (C) COLOR CODES:**
 (812G) NOS Gold Cloth / Gold
 (815G) NOS Blue Cloth / Lt Met Blue
 (821G) NOS Black Cloth / Black
- (C) HEADREST COLOR CODES:**
 (100G) Black
 (310G) Light Metallic Blue
 (650G) Gold

- Front Split Bench **AA67GKC0020(C)**
 (All Colors) \$973/ea. (L2)
 *812G, 815G & 821G use New Old Stock (NOS) cloth material.
- Coupe & Sport Coupe Rear...
AA67GKC0080(C)
 (All Colors) \$715/ea. (L2)
 *812G, 815G & 821G use New Old Stock (NOS) cloth material.
- Headrest Covers **HC66GA00014(C)**
 (All Colors) \$78/pr.
 Headrest Covers (Zippered) ... **HC66GA00Z14(C)**
 (All Colors) \$97/pr.

This Legendary product features NOS Cloth inserts and Madrid grain skirts

1967 SPECIAL DELUXE & SKYLARK

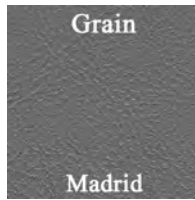

(C) COLOR CODES:

- (100G) Black
 - (240G) Metallic Parchment
(Requires Sample Approval)
 - (343G) Dark Metallic Blue
 - (448G) Dark Met. Turquoise
 - (501G) Red
 - (680G) Saddle
- *240G not available for convertible models*

This Legendary product features as-original heat sealed Madrid grain inserts and Madrid grain skirts

Front Split Bench with Center Armrest	AA67GK00030(C)
100G, 240G, 343G, 448G, 501G.	\$558/ea.
680G	\$1125/ea. (L1)
☞ 680G Saddle uses special run material.		
Rear Bench		
Coupe /Sport Coupe	AA67GK00048(C)
Convertible	AA67GK00056(C)
100G, 240G, 343G, 448G, 501G.	\$308/ea.
680G	\$868/ea. (L1)
☞ 240G Metallic Parchment and 448G Dark Metallic Turquoise were not offered on a split bench seat with center armrest interior trim style for convertible models in 1967.		
☞ 680G Saddle uses special run material.		
Headrest Covers	HC66GA00014(C)
100G, 240G, 343G, 448G, 501G.	\$78/pr.
680G	\$153/pr. (L1)
Headrest Covers (Zippered)	HC66GA000214(C)
100G, 240G, 343G, 448G, 501G.	\$97/pr.
680G	\$175/pr.
☞ 680G Saddle uses special run material.		
Convertible Rear Bench Back Panel	SK65GA00019(C)
100G, 343G, 501G	\$ 75/ea.
680G	\$235/ea. (L1)
☞ 680G Saddle uses special run material.		

1968 SKYLARK & SKYLARK CUSTOM

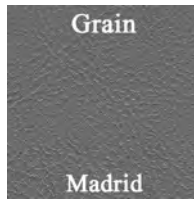

(C) COLOR CODES:

- (100G) Black
- (135G) NOS Platinum
(Requires Sample Approval)
- (220G) Frost White
- (333G) Teal Blue
- (502G) Red
- (709G) Buckskin

This Legendary product features as-original Heat Sealed Madrid grain inserts and Madrid grain skirts

Front Split Bench with Center Armrest	AA68GKD00030(C)
100G, 220G, 333G, 502G, 709G.	\$558/ea.
135G	\$1134/ea. (L1)
☞ Customer must reuse original metal buttons.		
Sport Coupe Rear	AA68GKD0048(C)
100G, 220G, 333G, 502G, 709G.	\$340/ea.
135G	\$889/ea. (L1)
☞ 502G Red and 709G Buckskin were not offered on a split bench seat with center armrest for a Coupe model in 1968.		
☞ Customer must reuse original metal buttons.		
Convertible Rear	AA68GKD0056(C)
100G, 220G, 333G, 502G, 709G.	\$340/ea.
135G	\$889/ea. (L1)
☞ 100G Black and 220G Frost White were not offered on a split bench seat with center armrest interior trim style for a Convertible model in 1968.		
☞ Customer must reuse original metal buttons.		

1968 SKYLARK CUSTOM & GRAN SPORT 400

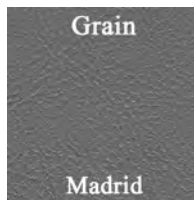

(C) COLOR CODES:

- (100G) Black
- (220G) Frost White

This Legendary product features as-original Heat Sealed Madrid grain inserts and Madrid grain skirts

Front Split Bench	AA68GKD0020(C)
(All Colors)	\$558/ea.
☞ Customer must reuse original metal buttons.		
Sport Coupe Rear	AA68GKD0048(C)
(All Colors)	\$340/ea.
☞ Customer must reuse original metal buttons.		
Convertible	AA68GKD0056(C)
(All Colors)	\$340/ea.
☞ Customer must reuse original metal buttons.		



1968 SKYLARK & GRAN SPORT 350



(C) COLOR CODES:
 (100G) Black
 (204G) Metallic Parchment
 (333G) Teal Blue

Front Split Bench **AA68GKS0020(C)**
 (All Colors) \$558/ea.
 ☞ Customer must reuse original metal buttons.

Sport Coupe Rear **AA68GKS0048(C)**
 (All Colors) \$340/ea.
 ☞ Customer must reuse original metal buttons.

This Legendary product features as-original Madrid grain inserts and Madrid grain skirts.

1969 SKYLARK & SKYLARK CUSTOM

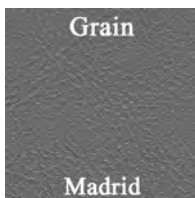
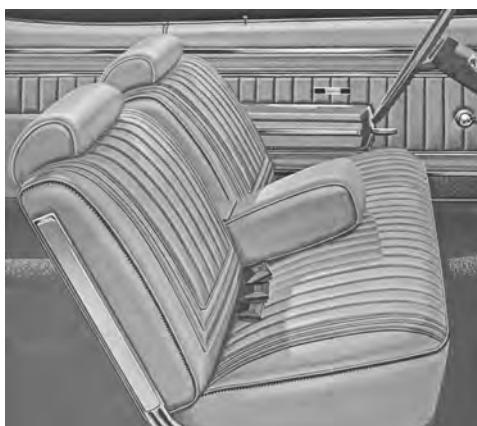

(C) COLOR CODES:
 (100G) Black
 (239G) Metallic Parchment
 (310G) Light Metallic Blue (Conv. Only)
 (325G) Metallic Blue (Hardtop Only)
 (450G) Metallic Green
 (710G) Buckskin

Front Split Bench with Center Armrest
 **AA69GKD0030(C)**
 100G, 239G, 310G, 325G,
 710G \$558/ea.
 450G \$1147/ea. (L1)
 ☞ 450G Metallic Green uses special run material.

Sport Coupe Rear
 **AA69GKD0048(C)**
 100G, 239G, 325G,
 710G \$308/ea.
 450G \$889/ea. (L1)
 ☞ 450G Metallic Green uses special run material.

Convertible Rear **AA69GKD0056(C)**
 100G, 310G, 710G \$308/ea.
 ☞ 239G Metallic Parchment and 450G Metallic
 Green were not offered on a split bench seat with
 center armrest interior trim style for a Convertible
 model in 1969.

Headrest Covers
 **HC69GA00N14(C)**
 100G, 310G \$78/pr.
 450G \$153/pr. (L1)
 ☞ 450G Metallic Green uses special run material.

This Legendary product features as-original Madrid grain inserts and Madrid grain skirts with heat sealed center collar.

1969 SKYLARK CUSTOM & GRAN SPORT 400

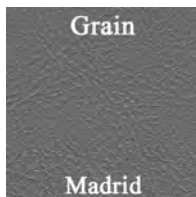

(C) COLOR CODES:
 (100G) Black
 (235G) Parchment

Front Split Bench **AA69GKD0020(C)**
 (All Colors) \$558/ea.

Sport Coupe Rear **AA69GKD0048(C)**
 (All Colors) \$308/ea.

Convertible Rear **AA69GKD0056(C)**
 (All Colors) \$308/ea.

Headrest Covers
 **HC69GA00N14(C)**
 (All Colors) \$78/pr.

This Legendary product features as-original Madrid grain inserts and Madrid grain skirts with heat sealed center collar.

1969 SKYLARK & GRAN SPORT 350

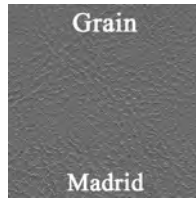

(C) COLOR CODES:

- (100G) Black
- (235G) Parchment
- (325G) Metallic Blue

Front Split Bench **AA69GKS0028(C)**
 (All Colors) \$558/ea.
 ☞ Customer must reuse original metal buttons.

Sport Coupe Rear **AA69GKS0080(C)**
 (All Colors) \$308/ea.
 ☞ Customer must reuse original metal buttons.

Headrest Covers
 **HC69GA00N14(C)**
 (All Colors) \$78/pr.

This Legendary product features as-original heat sealed Madrid grain inserts and Madrid grain skirts.

1970 SKYLARK SKYLARK CUSTOM, GS & GS 455

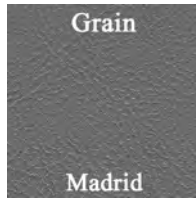

(C) COLOR CODES:

- (100G) Black
- (202G) Pearl White
- (460G) Metallic Green
- (658G) Burnished Saddle
- (683G) Saddle

Front Split Bench with Center Armrest
 **AA70GKD0030(C)**
 (All Colors) \$558/ea.

Sport Coupe Rear
 **AA70GKD0048(C)**
 (All Colors) \$308/ea.

Convertible **AA70GKD0056(C)**
 (All Colors) \$308/ea.
 ☞ 100G Black, 460G Metallic Green and 683G Saddle were not offered on a split bench seat with center armrest interior trim style for a Convertible model in 1970.

Headrest Covers
 **HC70GA00014(C)**
 (All Colors) \$78/pr.

This Legendary product features as-original Diamond Waffle grain inserts and Madrid grain skirts

1970 SKYLARK CUSTOM & GRAN SPORT 455

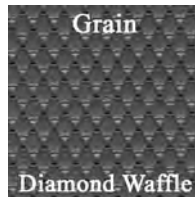
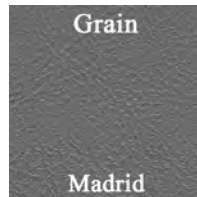

(C) COLOR CODES:

- (100G) Black
- (694G) Sandalwood

Front Split Bench
 **AA70GKD0020(C)**
 (All Colors) \$558/ea.

Convertible Rear **AA70GKD0056(C)**
 (All Colors) \$308/ea.

Headrest Covers
 **HC70GA00014(C)**
 (All Colors) \$78/pr.

This Legendary product features as-original Diamond Waffle grain inserts and Madrid grain skirts



1970 SKYLARK, GRAN SPORT & GRAN SPORT 455

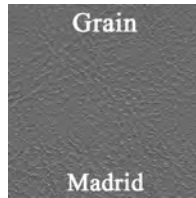

(C) COLOR CODES:
 (100G) Black
 (310G) Light Metallic Blue
 (694G) Sandalwood

Front Split Bench (All Colors).....	AA70GKS0020(C) \$558/ea.
<i>Customer must reuse original metal buttons.</i>	
Sport Coupe Rear (All Colors).....	AA70GKS0080(C) \$308/ea.
<i>Customer must reuse original metal buttons.</i>	
Headrest Covers (All Colors).....	HC70GA00014(C) \$78/pr.

This Legendary product features as-original heat sealed Madrid grain inserts and Madrid grain skirts.

1971 SKYLARK, SKYLARK CUSTOM & GRAN SPORT

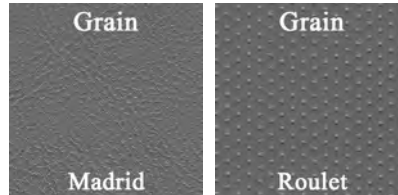

(C) COLOR CODES:
 (100G) Black
 (202G) Pearl White
 (468G) Green
 (690G) Saddle
 (697G) Sandalwood

Front Split Bench with Center Armrest (All Colors).....	AA71GK00030(C) \$558/ea.
Sport Coupe Rear (All Colors).....	AA71GK00048(C) \$320/ea.
Convertible Rear.....	AA71GK00056(C) \$320/ea.
<i>100G Black and 697G Sandalwood were not offered on a split bench seat with center armrest interior trim style for a Convertible model in 1971.</i>	
Headrest Covers (All Colors).....	HC70GA00014(C) \$78/pr.

This Legendary product features as-original Roulet grain inserts and Madrid grain skirts and accent bands

1971 SKYLARK & GRAN SPORT

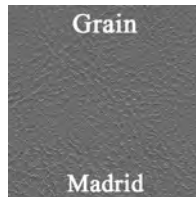

(C) COLOR CODES:
 (100G) Black
 (468G) Green
 (697G) Sandalwood

Front Split Bench..... (All Colors).....	AA71GKM0020(C) \$558/ea.
Sport Coupe Rear (All Colors).....	AA71GKM0080(C) \$320/ea.
Coupe Rear (All Colors).....	AA71GKM0088(C) \$320/ea.
Headrest Covers (All Colors).....	HC70GA00014(C) \$78/pr.

This Legendary product features as-original Heat Sealed Madrid grain inserts and Madrid grain skirts

1971 SKYLARK CUSTOM & GRAN SPORT



(C) COLOR CODES:
 (100G) Black
 (697G) Sandalwood

Front Split Bench	AA71GK00020(C)
(All Colors)	\$558/ea.
Convertible Rear	AA71GK00056(C)
(All Colors)	\$320/ea.
Headrest Covers	HC70GA00014(C)
(All Colors)	\$78/pr.

This Legendary product features as-original Roulet grain inserts and Madrid grain skirts and accent bands.

1972 SKYLARK, SKYLARK CUSTOM & GRAN SPORT



(C) COLOR CODES:
 (100G) Black
 (230G) White
 (465G) Green
 (690G) Saddle
 (695G) NOS Sandalwood

Front Split Bench with Center Armrest	AA71GK00030(C)
100G, 230G, 465G, 690G	\$558/ea.
695G	\$1273/ea. (L1)
Sport Coupe Rear	AA72GK00048(C)
100G, 230G, 465G, 690G	\$320/ea.
695G	\$1185/ea. (L1)
Convertible Rear	AA72GK00056(C)
(All Colors)	\$320/ea.
<i>100G Black and 695G Sandalwood were not offered on a split bench seat with center armrest interior trim style for a Convertible model in 1972.</i>	
Headrest Covers	HC70GA00014(C)
100G, 230G, 465G, 690G	\$78/pr.
695G	\$153/pr. (L1)

This Legendary product features as-original Roulet grain inserts and Madrid grain skirts and accent bands.

1972 SKYLARK CUSTOM & GRAN SPORT



(C) COLOR CODES:
 (100G) Black

Front Split Bench	AA71GK00020(C)
(All Colors)	\$558/ea.
Convertible Rear	AA72GK00056(C)
(All Colors)	\$320/ea.
Headrest Covers	HC70GA00014(C)
(All Colors)	\$78/pr.

This Legendary product features as-original Roulet grain inserts and Madrid grain skirts and accent bands.



1972 SKYLARK & GRAN SPORT

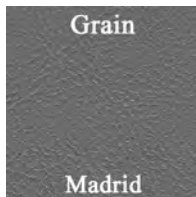

(C) COLOR CODES:

- (100G) Black
- (465G) Green
- (690G) Saddle

Front Split Bench **AA71GKM0020(C)**
 (All Colors) \$558/ea.

Sport Coupe Rear
 **AA72GKM0080(C)**
 (All Colors) \$320/ea.

Coupe Rear
 **AA72GKM0088(C)**
 (All Colors) \$320/ea.

Headrest Covers
 **HC70GA00014(C)**
 (All Colors) \$78/pr.

This Legendary product features as-original Heat Sealed Madrid grain inserts and Madrid grain skirts.

BUICK MODEL IDENTIFICATION

From 1964-1972 Buick offered the Skylark and Gran Sport in (3) different 2-door models: Coupe, Sport Coupe & Convertible. Shown is the basic identification for these models. Please note the difference between the Coupe (also known as a "pillared" coupe) and the Sport Coupe models.



**GS Sport Coupe
 Skylark Sport Coupe
 Skylark Custom Sport Coupe**
 *NOTE: NO post between door glass
 and rear quarter glass



**Skylark Custom Convertible
 GS Convertible**



Skylark Coupe
 *NOTE: Post between door glass
 and rear quarter glass

**1972 models shown in diagram*

SEAT ADJUSTMENT KNOBS



TA64GA-KNOB TA67GA-KNOB TA71GA-KNOB

Reproduction seat knobs move the seat forward and back. These will work for both bucket and bench seats. For bucket seats use (2) knobs, for bench seats use (1) knob.

1964-65 Skylark & GS

TA64GA-KNOB (Chrome).....\$29.00/ea.
 ☞ Will work for 1966 models but fit is slightly different.

1967-70 Skylark & GS

TA67GA-KNOB (Chrome).....\$10.00/ea.
 ☞ Some 1970 models use black seat knobs.

1971-72 Skylark & GS

TA71GA-KNOB (Black).....\$15.00/ea.

BENCH SEATBACK RELEASE KNOB



This seat release knob allows the seatback to fold forward on bench seat models.

1967-72 Skylark & GS

TA67GA-BNHKNOB (Chrome)..... \$10.00/ea.

BUCKET SEAT HEADRESTS

Reproduction bucket seat headrests made of molded urethane. Available in black only.



1966-67 Skylark & GS

HR66GA01.....\$259.00/pr.

1969 Skylark & GS

HR69GA01.....\$229.00/pr.

1970-72 Skylark & GS

HR70GA01.....\$229.00/pr.

BUCKET SEAT SPRING ASSEMBLY

Reproduction seat assemblies for 1964-72 Skylark & GS replace fatigued or broken springs and restore the comfort and support of the originals. Avoid the mistake of restoring your bucket seats without new, properly tensioned seat springs.

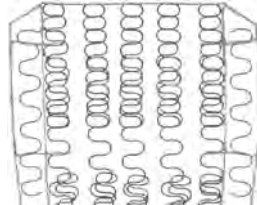

1964-65 Seatback (SA64GA-T)



1964-65 Seat bottom (SA64GA-B)

1964-65 Skylark & GS

SA64GA-T (Seatback) (Shown) \$159.00/ea.
SA64GA-B (Seat bottom) (Shown)...\$159.00/ea.

1966-67 Skylark & GS

SA66GA-T (Seatback) \$159.00/ea.
SA66GA-B (Seat bottom)\$159.00/ea.

1968-72 Skylark & GS

SA68GA-T (1968 Seatback) \$159.00/ea.
SA69GA-T (1969-72 Seatback) \$159.00/ea.
SA68GA-B (Seat bottom)..... \$159.00/ea.

SEATBACK BUMPERS



BU64GA-BKKIT

BU66GA-BKKIT

Rubber bumpers for 1964-1972 bucket seat models. These bumpers keep the front seat tops in the correct upright position and mount on the backside of the front seat bottoms.

1964-65 Skylark & GS

BU64GA-BKKIT (screws included).....\$10.00/pr.
 ☞ These bumpers will also fit most 1964-72 Tempest, LeMans & GTO bench seats.

1966-72 Skylark & GS

BU66GA-BKKIT (screws included).....\$10.00/pr.

BUCKET SEAT MOUNT CONVERSION BRACKETS



Die-stamped steel brackets allow you to mount bucket seats in 1966-72 models originally equipped with a bench seat.

TA66GA-BRACKET

☞ (1) set does (2) bucket seats. These brackets are to be welded near the transmission tunnel side so your inside bucket seat tracks can be mounted.

.....\$39.00/set

1966-67 BUCKET SEAT HEADREST MOUNTING KIT



1966-67 Skylark & GS

HR66GA-BRACKET \$109.00/pr.

BUCKET SEAT HEADRESTS BASE TRIM

Plastic base trim piece slides onto the headrest post and mounts to the underside of the headrest



HR68GA-BNH

1968-72 Skylark & GS

Bench Seat Style

HR68GA-BNH01 (black)\$26.00/pr.
HR68GA-BNH02 (white)\$26.00/pr.

☞ Plastic fasteners NOT INCLUDED

☞ Available in black or white. For colors other than black or white, customer must paint to match their interior color.



HR68GA-BKT

1968-72 Skylark & GS

Bucket Seat Style

HR68GA-BKT01 (black).....\$23.00/pr.
HR68GA-BKT02 (white).....\$23.00/pr.

☞ Plastic fasteners NOT INCLUDED

☞ Available in black or white. For colors other than black or white, customer must paint to match their interior color.



1964-65 BUCKET SEAT CHROME HINGE ROD END CAP



Chrome plated reproduction of the original end caps.

SK64GA-CAP\$5.00/ea.

1969-72 BUCKET HEADREST LOCK ASSEMBLY

Authentic reproduction chrome plated bucket seat headrest locks include the escutcheon and lock as part of the lock assembly. These mount to the bucket front seat tops where the headrest posts slide into the seat.



1969 Skylark & GS
HR69GA-COVER\$59.00/pr.

1970-72 Skylark & GS
HR70GA-COVER (shown)\$49.00/pr.

BUCKET SEATBACK RELEASE BUTTONS

These seat release buttons allow the seatback to fold forward on bucket seat models.



1967-68 Skylark & GS
SK67GA-BUTTON\$49.00/ea.

1969-72 Skylark & GS
SK69GA-BUTTON\$39.00/ea.

SEAT BOTTOM STRETCH PANEL BOARDS

Die-cut seat bottom stretch panel boards for 1965-72 bucket seats. These panel boards attach to the back-side of the bottom seat frame under the upholstery.



1965 Skylark & GS
SK65GA-PANEL (Bucket seats only) ...\$26.00/pr.

1966-67 Skylark & GS
SK66GA-BNHPANEL (Bench seats only)..\$35.00/ea.



1966-72 Skylark & GS
SK66GA-PANEL (Bucket seats only)\$6.00/pr.

FOAM & COTTON ACCESSORIES

- Cotton Batting (1 Roll)
- TACOTTONROLL**\$48.00/ea.
- 1 Roll consists of 10 lbs.
- Must be used in conjunction with Legendary muslin.
- Muslin (1 yard)
- TAYDMUSLIN**.....\$ 3.00/yd.
- Must be used in conjunction with Legendary cotton batting.
- High Density Foam
- TAFOAM1 (1.5" thick x12" x12")**\$20.00/ea.
- TAFOAM2 (1.5" thick x 24" x 24")**\$38.00/ea.
- TAFOAM3 (1.5" thick x 30" x 70")**\$82.00/ea.
- Burlap (36" wide)
- TABURLAP**\$ 3.00/yd.
- Paper Coated Wire
- TAPAPERWIRE**.....\$ 2.50/ft.

HOG RING PLIER KITS



- Standard Hog Ring Plier Kit
- TAHOG**\$ 8.00/ea.
- Kit contains pliers and enough hog rings for a front or rear installation only.
- Deluxe Hog Ring Plier Kit
- TAHOHVY (shown)**.....\$32.00/ea.
- Kit contains heavy duty pliers and enough hog rings for a complete front and rear installation.
- Hog Rings (Pkg/200)
- TAHOGRING200**.....\$ 5.00/pk.

1966-72 BUCKET SEATBACKS



Reproduction seatbacks are made of original-style heat-stamped plastic and feature the correct Madrid grain look. Each seatback has been manufactured to original specifications. Chrome beading included.

1966 Skylark & GS
SK66GA01T (Black)..... discontinued
SK66GA(C)T (Colors)..... discontinued
 ☞ 1966 seatbacks were originally metal.

1968 Skylark & GS
SK68GA01T (Black)..... \$119.00/pr.
SK68GA(C)T (Colors)..... \$119.00/pr.
 ☞ Please specify color at time of order.

1969-72 Skylark & GS
SK69GA01T (Black)..... \$119.00/pr.
SK69GA(C)T (Colors)..... \$119.00/pr.
 ☞ Please specify color at time of order.

1966-72 BUCKET SEAT BASES



Reproduction lower seat bases are made of original-style heat-stamped plastic and feature the correct Madrid grain look. Chrome beading included. Please specify color at time of order.

☞ (1) pair = (1) seat, (2) pairs required for (2) seats.
 ☞ Please specify color at time of order.
 ☞ 1966-67 seat bases were originally metal.

1966-67 Skylark & GS
SK66GA01B (Black).....\$99.00/pr.
SK66GA(C)B (Colors).....\$99.00/pr.

1968 Skylark & GS
SK68GA01B (Black).....\$99.00/pr.
SK68GA(C)B (Colors).....\$99.00/pr.

1969-72 Skylark & GS
SK69GA01B (Black).....\$99.00/pr.
SK69GA(C)B (Colors).....\$99.00/pr.

1966 COLOR CODES (C)	
(01) Black	(04) Turquoise
(02) White	(10) Bright Blue
(03) Red	(18) Light Blue

1967 COLOR CODES (C)	
(01) Black	(04) Turquoise
(02) White	(10) Bright Blue
(03) Red	(18) Light Blue

1968 COLOR CODES (C)	
(01) Black	(18) Light Blue
(03) Red	(204) Metallic Parchment
(11) Medium Blue	

1969-72 COLOR CODES (C)	
(01) Black	(27) Light Saddle
(02) White	(29) Dark Saddle
(03) Red	(38) Sandalwood
(07) Dark Blue	(235) Parchment
(10) Bright Blue	(239) Metallic Parchment
(13) Dark Green	

1966-72 BUCKET SEAT CHROME TRIM & "BULLET" END CAPS



Chrome Trim
SK66GA-CHR.....\$29.00/set



"Bullet" End Caps
SK66GA-CAP (Set/12).....\$29.00/set



Check out our Official **FAST FACTS!!** **LEGENDARY Tech Topics** with C.O.O. and Technical Muscle Car Guru Brian Ridley at blog.legendariautointeriors.com





MOLDED FOAM AND FOAM ACCESORIES

 facebook.com/legendaryautointeriors
 twitter.com/legendaryautoin

 www.legendaryautointeriors.com
 instagram.com/legendaryautointeriorsltd
 youtube.com/user/legendaryauto

ORIGINAL REPRODUCTION SEAT FOAM

Don't put new seat covers over old deteriorated foam cushions! With these A.C.I. "Quality Replacements," you will enjoy the appearance and comfort of factory new again in your Skylark and Gran Sport. These A.C.I. original reproduction foam kits feature their exclusive cold cure molding process and a limited lifetime guarantee.



1964-65 BUCKET SEAT FOAM

Molded foam for 1964-65 Skylark and Gran Sport models with bucket seats. Sets consist of a pair of (2) front seat tops and (2) front seat bottoms.



American Cushion Industries

Precision Molded Seat Cushions

MF62GASETAC

\$359.00/set

Professional installation is highly recommended. Please see our installation services at the back of the catalog.

1966 BUCKET SEAT FOAM

Molded foam for 1966 Skylark and Gran Sport models with bucket seats. Sets consist of a pair of (2) front seat tops and (2) front seat bottoms.



American Cushion Industries

Precision Molded Seat Cushions

MF66GASETAC

\$359.00/set

Professional installation is highly recommended. Please see our installation services at the back of the catalog.

1967 & 1969-70 SKYLARK/GS BUCKET SEAT FOAM

Molded foam for 1967 Skylark/Gran Sport and 1969-70 Skylark/Gran Sport models with bucket seats. Sets consist of a pair of (2) front seat tops and (2) front seat bottoms.



American Cushion Industries

Precision Molded Seat Cushions

MF67GASETAC

\$359.00/set

Professional installation is highly recommended. Please see our installation services at the back of the catalog.

1968 & 1971-72 SKYLARK/GS BUCKET SEAT FOAM

Molded foam for 1968 Skylark/Gran Sport and 1971-72 Skylark/Gran Sport models with bucket seats. Sets consist of a pair of (2) front seat tops and (2) front seat bottoms.



American Cushion Industries

Precision Molded Seat Cushions

MF71GASETAC

\$359.00/set

Professional installation is highly recommended. Please see our installation services at the back of the catalog.



1966-70 BENCH SEAT FOAM

Molded foam for 1966-70 Skylark and Gran Sport models with bench seats. Sets consist of (1) front seat top and (1) front seat bottom.



American Cushion Industries

Precision Molded Seat Cushions

1971-72 BENCH SEAT FOAM

Molded foam for 1971-72 Skylark and Gran Sport models with bench seats. Sets consist of (1) front seat top and (1) front seat bottom.



American Cushion Industries

Precision Molded Seat Cushions

MF66GA-BENCH

\$379.00/set

Professional installation is highly recommended. Please see our installation services at the back of the catalog.

MF71GA-BENCH

\$489.00/set

Professional installation is highly recommended. Please see our installation services at the back of the catalog.

SEAT INSTALLATION KITS

HARDTOP AND CONVERTIBLE REAR SEATS

All 1964-72 General Motors A-Body



INSTALLATION-KIT2.....\$279.00/ea.

Kit includes: (1) 30"x70" 1 1/2" thick foam, (1) 10lb. roll of cotton, 4 yards of burlap, 4 yards of paper coated listing wire, 2 yards of muslin, (1) 3 1/2" x 64" Wire Edge Reinforced Burlap Cotton Support Band & a dust mask.

SPLIT BENCH & FULL BENCH FRONT SEATS

All 1964-72 General Motors A-Body

*With & Without Center Armrest



INSTALLATION-KIT4.....\$279.00/ea.

Kit includes: (1) 30"x70" 1 1/2" thick foam, (1) 10lb. roll of cotton, 4 yards of burlap, 4 yards of paper coated listing wire, 2 yards of muslin, 3 yards of 2 inch wide felt, (1) 3 1/2" x 64" Wire Edge Reinforced Burlap Cotton Support Band & a dust mask.

BUCKET FRONT SEATS



Kit 10 - 1964-65

INSTALLATION-KIT10.....\$89.00/ea.

Kit includes: (1) 5lb. roll of cotton, 2 yards of burlap, 45 feet of paper coated listing wire, 3 yards of 2 inch wide felt, (1) 3 1/2" x 64" Wire Edge Reinforced Burlap Cotton Support Band a dust mask & Side Hinge Felt.

BUCKET FRONT SEATS

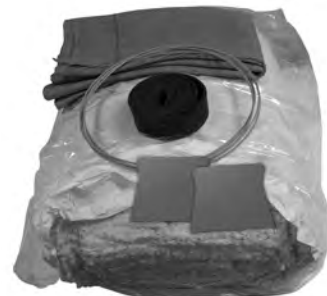

Kit 3 - 1966-72

INSTALLATION-KIT3.....\$69.00/ea.

Kit includes: (1) 5lb. roll of cotton, 2 yards of buap, 30 feet of paper coated listing wire, 3 yards of 2 inch wide felt, (2) stretch panel boards & a dust mask.

INSTALLATION SERVICES

GM, CHRYSLER & AMC SEAT UPHOLSTERY

(Includes tear down of original upholstery and installation of new upholstery)



Front Buckets Install - \$500.00/pr.
(No Headrest Covers)



Front Buckets w/ Headrest Covers Install - \$600.00/pr.



Front Split Bench Install - \$575.00/ea.



Front Split Bench w/ Headrest Covers Install - \$675.00/ea.



Rear Bench Seat Install - \$400.00/ea.



Headrest Covers Install - \$150.00/pr.

Center Armrest Install - \$150.00/ea.
(for models w/ buckets and no console)



SAVE ON COMPLETE FRONT & REAR INSTALLS!!

Front Buckets & Rear Bench Seat Install - \$750.00/set

Front Buckets w/ Headrest Covers & Rear Bench Seat Install - \$850.00/set

Front Split Bench & Rear Bench Seat Install - \$825.00/set



Front Split Bench w/ Headrest Covers & Rear Bench Seat Install - \$925.00/set



**NOTE* Basic installations DO NOT include new foam and cotton replacement or reconstruction, media blasting, painting, welding, frame straightening, polishing or trim detailing. These services are additional and available at an hourly rate. Please call for more details. 1-800-363-8804*





DOOR PANEL AND TRIM ACCESORIES

 facebook.com/legendaryautointeriors
 twitter.com/legendaryautoin

 www.legendaryautointeriors.com
 instagram.com/legendaryautointeriorsltd
 youtube.com/user/legendaryauto

1964 SKYLARK



**Padded
Multi-Level
Construction
3D Panel**

(C) COLOR CODES:

- (111G) Black with Silver Accent Band
- (221G) Frost White with Black Accent Band
- (311G) Light Metallic Blue with Powder Blue Accent Band
- (370G) Dark Metallic Blue with Powder Blue Accent Band
- (426G) Metallic Green with Frost White Accent Band
- (509G) Red with Frost White Accent Band
- (675G) Brown with Frost White Accent Band



(C) ARMREST/WELL COVER COLOR CODES:

- (100G) Black
- (220G) Frost White
- (325G) Light Metallic Blue
- (334G) Dark Metallic Blue
- (405G) Metallic Green
- (508G) Red
- (656G) Brown

This Legendary product features as-original Die-electrically heat sealed Seville A grain vinyl Seville grain accent band, buttons and carpeted lower section. Special cutout area in filler board to accommodate armrest base. Padded Multi-Level Construction 3-Dimensional Panel.
NOTE: Customer must reuse original decorative trim and medallions. Medallions are available. See following section of catalog.

Front Panels

- **DO64GK00012(C)**
- 111G, 221G, 509G, 675G.....\$481/pr.
- 311G, 370G\$625/pr. (L1)
- 426G.....\$862/pr. (L1)
- ☞ Please specify carpet color and accent band color at time of order.
- ☞ Customer must reuse original metal trim.
- ☞ 311G Powder Blue Accent and 405G Metallic Green uses special run material.

Sport Coupe Rear Panels

- **DO64GK00048(C)**
- 111G, 221G, 370G, 509G, 675G\$277/pr.
- 370G.....\$375/pr. (L1)
- 426G.....\$425/pr. (L1)
- ☞ Please specify accent band color at time of order.
- ☞ Customer must reuse original metal trim.
- ☞ 405G Metallic Green uses special run material.

Sport Coupe Armrest/Well Covers

- **AW64GA00048(C)**
- 100G, 220G, 334G, 508G, 656G....\$78/pr.
- 405G.....\$174/pr. (L1)
- ☞ 405G Metallic Green uses special run material.

Convertible Rear Panels

- **DO64GK00056(C)**
- 111G, 221G, 509G, 656G.....\$277/pr.
- 311G, 370G\$328/pr. (L1)
- 426G.....\$403/pr. (L1)
- ☞ Please specify accent band color at time of order.
- ☞ Customer must reuse original metal trim.
- ☞ 311G Powder Blue Accent and 405G Metallic Green uses special run material.

Convertible Armrest/Well Covers

- **AW64GA00056(C)**
- 100G, 220G, 325G, 508G, 656G...\$ 96/pr.
- 405G.....\$214/pr. (L1)
- ☞ 405G Metallic Green uses special run material.

1965 SKYLARK & GRAN SPORT



**Padded
Multi-Level
Construction
3D Panel**

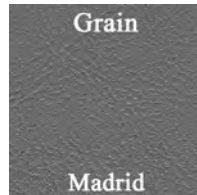

(C) COLOR CODES:

- (100G) Black
- (220G) Frost White
- (325G) Light Metallic Blue
- (343G) Dark Metallic Blue
- (520G) Metallic Red
- (679G) Saddle

This Legendary product features as-original Die-electrically heat sealed Madrid grain vinyl with carpeted lower section. Special cutout area in filler board to accommodate armrest base. Padded Multi-Level Construction 3-Dimensional Panel.
NOTE: Customer must reuse original decorative trim and medallions. Medallions are available. See following section of catalog.

- Front Panels DO65GK00012(C)**
- 100G, 220G, 325G, 343G, 520G. \$415/pr.
- 679G.....\$862/pr. (L1)
- ☞ Please specify carpet color at time of order.
- ☞ Customer must reuse original metal trim.

- Sport Coupe Rear Panels.... DO65GK00048(C)**
- 100G, 220G, 325G, 343G, 520G \$211/pr.
- 679G.....\$425/pr. (L1)
- ☞ Customer must reuse original metal trim.
- ☞ 100G Black was not offered on a bucket seat interior trim style for a Sport Coupe model in 1965.

- Convertible Rear Panels..... DO65GK00056(C)**
- 100G, 220G, 325G, 343G, 520G. \$211/pr.
- 679G.....\$403/pr. (L1)
- ☞ Customer must reuse original metal trim.
- ☞ 343G Dark Metallic Blue was not offered on a bucket seat interior trim style for a Convertible model in 1965.

- Sport Coupe Armrest/Well Covers**
- **AW65GA00048(C)**
- 100G, 220G, 325G, 343G, 520G..\$78/pr.
- 679G.....\$174/pr. (L1)

- Convertible Armrest/Well Covers**
- **AW65GA00056(C)**
- 100G, 220G, 325G, 343G, 520G. \$96/pr.
- 679G.....\$214/pr. (L1)



1966 SPECIAL DELUXE, SKYLARK & GRAN SPORT

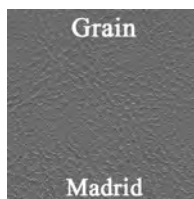

(C) COLOR CODES:
 (100G) Black
 (240G) Metallic Parchment
 (325G) Light Metallic Blue
 (420G) NOS Light Metallic Aqua
 (520G) Metallic Red

This Legendary product features as-original Die-electrically heat sealed Madrid grain vinyl with chrome accent strips and carpeted lower section. Special cutout area in filler board to accommodate armrest base. Padded Multi-Level Construction 3-Dimensional Panel.

NOTE: Customer must reuse original decorative trim and medallions. Medallions are available. See following section of catalog.

Front Panels	DO66GKD0012(C)
100G, 240G, 325G, 520G.....	\$401/pr.
420G.....	\$765/pr. (L1)
☞ Please specify carpet color at time of order.	
☞ Customer must reuse original metal trim.	
Coupe & Sport Coupe Rear Panels	DO66GKD0048(C)
100G, 240G, 325G, 520G.....	\$211/pr.
420G.....	\$331/pr. (L1)
☞ Customer must reuse original metal trim.	
Convertible Rear Panels	DO66GKD0056(C)
(All Colors).....	\$211/pr.
☞ Customer must reuse original metal trim.	
☞ 420G Light Metallic Aqua was not offered for a Convertible model in 1966.	
Coupe & Sport Coupe Armrest/Well Covers	AW65GA00048(C)
100G, 240G, 325G, 520G.....	\$78/pr.
420G.....	\$174/pr. (L1)
Convertible Armrest/Well Covers	AW66GA00056(C)
(All Colors).....	\$96/pr.

1967 SPECIAL DELUXE, SKYLARK & GRAN SPORT

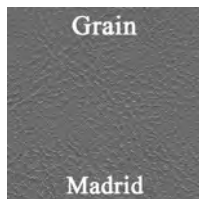

(C) COLOR CODES:
 (100G) Black
 (240G) Metallic Parchment (Requires Sample Approval)
 (310G) Light Metallic Blue
 (343G) Dark Metallic Blue
 (448G) Dark Metallic Turquoise
 (501G) Red
 (640G) Pearl Yellow
 (650G) Gold
 (680G) Saddle
 *240G not available for convertible models

This Legendary product features as-original Die-electrically heat sealed Madrid grain vinyl with chrome accent strips and carpeted lower section. Special cutout area in filler board to accommodate armrest base. Padded Multi-Level Construction 3-Dimensional Panel.
 NOTE: Customer must reuse original decorative trim and medallions. Medallions are available. See following section of catalog.

Front Panels	DO67GKD0012(C)
100G, 240G, 310G, 343G, 448G, 501G, 640G, 650G.....	\$401/pr.
680G.....	\$765/pr.
☞ Please refer to carpet color selection page to specify carpet color at time of order.	
☞ Customer must reuse original metal trim.	
☞ 680G Saddle uses special run material.	
☞ 310G Light Metallic Blue and 650G Gold were available with a Cloth Bench interior trim style only.	
Sport Coupe Rear Panels	DO67GKD0048(C)
100G, 240G, 310G, 343G, 448G, 501G, 640G, 650G.....	\$211/pr.
680G.....	\$332/pr.
☞ 680G Saddle uses special run material.	
☞ 310G Light Metallic Blue and 650G Gold were available with a Cloth Bench interior trim style only.	
Sport Coupe Armrest/Well Covers	AW65GA00048(C)
100G, 240G, 310G, 343G, 448G, 501G, 640G, 650G.....	\$78/pr.
680G.....	\$174/pr.
☞ 680G Saddle uses special run material.	
Convertible Rear Panels	DO67GKD0056(C)
100G, 240G, 343G, 501G, 640G.....	\$211/pr.
680G.....	\$332/pr. (L1)
☞ 680G Saddle uses special run material.	
☞ 310G Light Metallic Blue, 448G Dark Metallic Aqua and 650G Gold were not offered for a Convertible model in 1967.	
Convertible Armrest/Well Covers	AW66GA00056(C)
100G, 220G, 343G, 501G, 640G.....	\$ 96/pr.
680G.....	\$214/pr. (L1)
☞ 680G Saddle uses special run material.	

1968 SKYLARK, SKYLARK CUSTOM, GS 350 & 400



Padded Multi-Level Construction 3D Panel

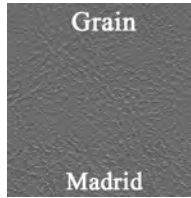

- (C) COLOR CODES:**
 (100G) Black
 (135G) NOS Platinum
 (Requires Sample Approval)
 (220G) Frost White
 (333G) Teal Blue
 (502G) Red
 (709G) Buckskin

This Legendary product features as-original Die-electrically heat sealed Madrid grain vinyl with chrome accent strips and carpeted lower section. Special cutout area in filler board to accommodate armrest base. Padded Multi-Level Construction 3-Dimensional Panel.

NOTE: Customer must reuse original decorative trim and medallions. Medallions are available. See following section of catalog.

- Front Panels**
 (Unassembled) **DO68GKD0012(C)**
 100G, 220G, 333G, 502G, 709G... \$459/pr.
 135G \$765/pr. (L1)
 (Pre-assembled) ^{OS1} **DO68GKD0012(C)-PA**
 100G, 220G, 333G, 502G, 709G... \$605/pr.
 135G \$1075/pr. (L1)
 ☞ Please refer to carpet color selection page to specify carpet color at time of order.

- Sport Coupe Rear Panels**
 (Unassembled) **DO68GKD0048(C)**
 100G, 220G, 333G, 502G, 709G... \$317/pr.
 135G \$369/pr. (L1)
 (Pre-assembled) ^{OS1} **DO68GKD0048(C)-PA**
 100G, 220G, 333G, 502G, 709G... \$483/pr.
 135G \$705/pr. (L1)
 ☞ Customer must provide upper rails.

- Convertible Rear Panels**
 (Unassembled) **DO68GKD0056(C)**
 100G, 220G, 333G, 502G, 709G... \$317/pr.
 135G \$369/pr. (L1)
 (Pre-assembled) ^{OS1} **DO68GKD0056(C)-PA**
 100G, 220G, 333G, 502G, 709G... \$483/pr.
 135G \$705/pr. (L1)
 ☞ Customer must provide upper rails.

- Sport Coupe Armrest/Well Covers**
 **AW68GA00048(C)**
 100G, 220G, 333G, 502G, 709G... \$78/pr.
 135G \$174/pr. (L1)

- Convertible Armrest/Well Covers**
 **AW68GA00056(C)**
 100G, 220G, 333G, 502G, 709G... \$96/pr.
 135G \$214/pr. (L1)

1968 SKYLARK & GRAN SPORT 350



Padded Multi-Level Construction 3D Panel

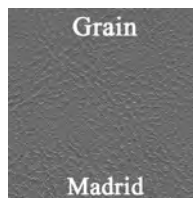

- (C) COLOR CODES:**
 (100G) Black
 (201G) Metallic Parchment / Black
 (333G) Teal Blue

This Legendary product features as-original Die-electrically heat sealed Madrid grain vinyl with chrome accent belt. Special cutout area in filler board to accommodate armrest base. Padded Multi-Level Construction 3-Dimensional Panel.

NOTE: Customer must reuse original decorative trim and medallions. Medallions are available. See following section of catalog.

- Front Panels**
 (Unassembled) **DO68GKS0012(C)**
 \$459/pr.
 (Pre-assembled) ^{OS1} **DO68GKS0012(C)-PA**
 \$605/pr.
 ☞ Customer must provide upper rails.
 ☞ Customer must reuse original metal trim.

- Sport Coupe Rear Panels**
 (Unassembled) **DO68GKS0048(C)**
 \$317/pr.
 (Pre-assembled) ^{OS1} **DO68GKS0048(C)-PA**
 \$483/pr.
 ☞ Customer must provide upper rails.
 ☞ Customer must reuse original metal trim.

1969 SKYLARK & GRAN SPORT 350

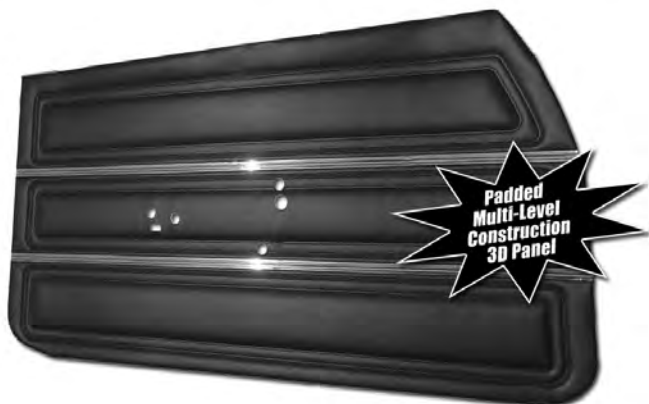

Padded Multi-Level Construction 3D Panel

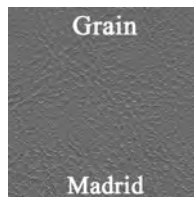

- (C) COLOR CODES:**
 (100G) Black
 (235G) Parchment
 (325G) Light Metallic Blue

This Legendary product features as-original Die-electrically heat sealed Madrid grain vinyl with double chrome accent bands. Special cutout area in filler board to accommodate armrest base. Padded Multi-Level Construction 3-Dimensional Panel.

NOTE: Customer must reuse original decorative trim and medallions. Medallions are available. See following section of catalog.

- Front Panels**
 (Unassembled) **DO69GKS0012(C)**
 \$459/pr.
 (Pre-assembled) ^{OS1} **DO69GKS0012(C)-PA**
 \$605/pr.

- Sport Coupe Rear Panels**
 (Unassembled) **DO69GKS0048(C)**
 \$317/pr.
 (Pre-assembled) ^{OS1} **DO69GKS0048(C)-PA**
 \$483/pr.



1969 SKYLARK, SKYLARK CUSTOM, GRAN SPORT 350 & 400



This Legendary product features as-original Die-electrically heat sealed Madrid grain vinyl with chrome accent belt and carpeted lower section. Special cutout area in filler board to accommodate armrest base. Padded Multi-Level Construction 3-Dimensional Panel.
 NOTE: Customer must reuse original decorative trim and medallions. Medallions are available. See following section of catalog.

(C) COLOR CODES:

- (100G) Black
- (239G) Metallic Parchment
- (235G) Parchment
- (325G) Metallic Blue
- (450G) Metallic Green
- (503G) Red
- (710G) Buckskin

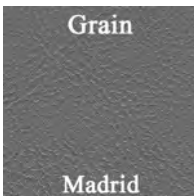

Front Panels
 (Unassembled) **DO69GKD0012(C)**
 100G, 239G, 240G, 325G, 503G, 710G . \$459/pr.
 450G \$765/pr. (L1)
 ☞ Please refer to carpet color selection page to specify carpet color at time of order.
 ☞ 450G Metallic Green uses special run material.

Front Panels
 (Pre-assembled) ^{OS1} **DO69GKD0012(C)-PA**
 100G, 239G, 240G, 325G, 503G, 710G \$605/pr.
 450G \$1075/pr. (L1)
 ☞ Includes original style upper metal rail, door lock ferrules & windowfelt strip.
 ☞ Please specify carpet color.
 ☞ 450G Metallic Green uses special run material.

Sport Coupe Rear Panels
 (Unassembled) **DO69GKD0048(C)**
 100G, 239G, 325G, 710G \$317/pr.
 450G \$369/pr. (L1)
 ☞ 450G Metallic Green uses special run material.

Sport Coupe Rear Panels
 (Pre-assembled) ^{OS1} **DO69GKD0048(C)-PA**
 100G, 239G, 325G, 710G \$483/pr.
 450G \$705/pr. (L1)
 ☞ Customer must provide upper rails.
 ☞ 450G Metallic Green uses special run material.

Convertible Rear Panels
 (Unassembled) **DO69GKD0056(C)**
 100G, 239G, 240G, 325G, 503G, 710G... \$317/pr.

Convertible Rear Panels
 (Pre-assembled) ^{OS1} **DO69GKD0056(C)-PA**
 100G, 239G, 240G, 325G, 503G, 710G... \$483/pr.
 ☞ Customer must provide upper rails.

Sport Coupe Armrest/Well Covers
 **AW68GA00048(C)**
 100G, 239G, 325G, 710G . \$78/pr.
 450G \$174/pr. (L1)
 ☞ 450G Metallic Green uses special run material.

Convertible Armrest/Well Covers
 **AW68GA00056(C)**
 100G, 239G, 240G, 343G, 503G, 640G... \$96/pr.

1970 SKYLARK, GRAN SPORT & GRAN SPORT 455



(C) COLOR CODES:

- (100G) Black
- (316G) Dark Met. Blue / Light Met. Blue
- (691G) Dark Sandalwood/Sandalwood

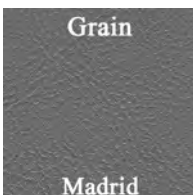

Front Panels
 (Unassembled) **DO70GKD0020(C)**
 \$459/pr.
 (Pre-assembled) ^{OS1} **DO70GKD0020(C)-PA**
 \$605/pr.

Sport Coupe Rear Panels
 (Unassembled) **DO70GKD0080(C)**
 \$317/pr.
 (Pre-assembled) ^{OS1} **DO70GKD0080(C)-PA**
 \$456/pr

Sport Coupe Armrest/Well Covers
 **AW68GA00048(C)**
 (Unassembled) \$78/pr.

This Legendary product features as-original Die-electrically Madrid grain vinyl with chrome accent band and chrome accent welt. Special cutout area in filler board to accommodate armrest base. Padded Multi-Level Construction 3-Dimensional Panel.
 NOTE: Customer must reuse original decorative trim and medallions. Medallions are available. See following section of catalog.

1970 SKYLARK, SKYLARK CUSTOM, GS & GS 455

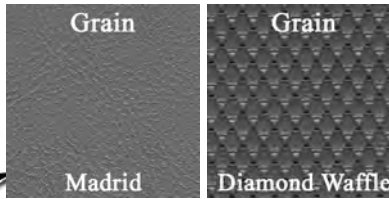

(C) COLOR CODES:

- (100G) Black
- (202G) Pearl White
- (342G) Dark Metallic Blue
- (460G) Metallic Green
- (658G) Burnished Saddle
- (683G) Saddle
- (694G) Sandalwood

This Legendary product features as-original Die-electrically heat sealed Madrid grain vinyl with Diamond Waffle grain inserts and double-stitched accent belts. Special cutout area in filler board to accommodate armrest base. Padded Multi-Level Construction 3-Dimensional Panel.

NOTE: Customer must reuse original decorative trim and medallions. Medallions are available. See following section of catalog.

Front Panels (Unassembled)	DO70GK00012(C)
.....	\$459/pr.
(Pre-assembled)	DO70GK00012(C)-PA
.....	\$605/pr.

Sport Coupe Rear Panels (Unassembled)	DO70GK00048(C)
.....	\$317/pr.
(Pre-assembled)	DO70GK00048(C)-PA
.....	\$456/pr.

Sport Coupe Armrest/Well Covers	AW68GA00048(C)
.....	\$78/pr.

Convertible Rear Panels (Unassembled)	DO70GK00056(C)
.....	\$317/pr.
(Pre-assembled)	DO70GK00056(C)-PA
.....	\$456/pr.

Convertible Armrest/Well Covers	AW68GA00056(C)
.....	\$96/pr.

1971 SKYLARK, SKYLARK CUSTOM & GRAN SPORT

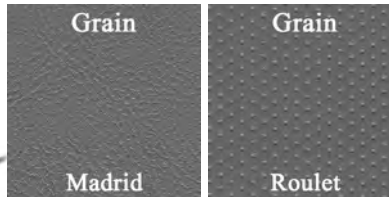

(C) COLOR CODES:

- (100G) Black
- (202G) Pearl White
- (468G) Green
- (690G) Saddle
- (697G) Sandalwood

This Legendary product features as-original Die-electrically heat sealed Madrid grain vinyl with Roulet grain insert and double-stitched accent belts. Special cutout area in filler board to accommodate armrest base. Padded Multi-Level Construction 3-Dimensional Panel.

NOTE: Customer must reuse original decorative trim and medallions. Medallions are available. See following section of catalog.

Front Panels (Unassembled)	DO71GKS0012(C)
.....	\$459/pr.
(Pre-assembled)	DO71GKS0012(C)-PA
.....	\$605/pr.

Sport Coupe Rear Panels (Unassembled)	DO71GKS0048(C)
.....	\$317/pr.
(Pre-assembled)	DO71GKS0048(C)-PA
.....	\$456/pr.

Sport Coupe Armrest/Well Covers	AW68GA00048(C)
.....	\$78/pr.

Convertible Rear Panels (Unassembled)	DO71GKS0056(C)
.....	\$317/pr.
(Pre-assembled)	DO71GKS0056(C)-PA
.....	\$456/pr.

Convertible Armrest/Well Covers	AW68GA00056(C)
.....	\$96/pr.

1971 SKYLARK & GRAN SPORT



(C) COLOR CODES:

- (100G) Black
- (468G) Green
- (697G) Sandalwood

This Legendary product features as-original Die-electrically heat sealed Madrid grain vinyl with chrome accent strip. Special cutout area in filler board to accommodate armrest base. Padded Multi-Level Construction 3-Dimensional Panel.

NOTE: Customer must reuse original decorative trim and medallions. Medallions are available. See following section of catalog.

Sport Coupe Front Panels (Unassembled)	DO71GKS0028(C)
.....	\$459/pr.
(Pre-assembled)	DO71GKS0028(C)-PA
.....	\$605/pr.

Coupe Front Panels (Unassembled)	DO71GKS0020(C)
.....	\$459/pr.
(Pre-assembled)	DO71GKS0020(C)-PA
.....	\$638/pr.

Sport Coupe Rear Panels (Unassembled)	DO71GKS0080(C)
.....	\$317/pr.
(Pre-assembled)	DO71GKS0080(C)-PA
.....	\$456/pr.

Coupe Rear Panels (Unassembled)	DO71GKS0088(C)
.....	\$317/pr.
(Pre-assembled)	DO71GKS0088(C)-PA
.....	\$483/pr.

Sport Coupe Armrest/Well Covers (Unassembled)	AW68GA00048(C)
.....	\$78/pr.



1972 SKYLARK CUSTOM & GRAN SPORT



(C) COLOR CODES:

- (100G) Black
- (230G) White
- (465G) Green
- (690G) Saddle



Front Panels (Unassembled)	DO71GKS0012(C)
.....	\$459/pr.
(Pre-assembled) ...	DO71GKS0012(C)-PA
.....	\$605/pr.
Convertible Rear Panels (Unassembled)	DO71GKS0056(C)
.....	\$317/pr.
Convertible Rear Panels (Pre-assembled) ...	DO71GKS0056(C)-PA
.....	\$456/pr.
Convertible Armrest/Well Covers	AW68GA00056(C)
.....	\$96/pr.

This Legendary product features as-original Die-electrically heat sealed Madrid grain vinyl with Roulet grain inserts and double-stitched accent belts. Special cutout area in filler board to accommodate armrest base. Padded Multi-Level Construction 3-Dimensional Panel.

NOTE: Customer must reuse original decorative trim and medallions. Medallions are available. See following section of catalog.

1972 SKYLARK & GRAN SPORT

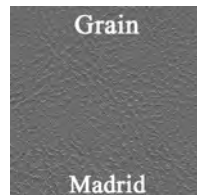

(C) COLOR CODES:

- (100G) Black
- (465G) Green
- (690G) Saddle

Sport Coupe Front Panels (Unassembled)	DO71GKS0028(C)
.....	\$459/pr.
(Pre-assembled) ^{OS1}	DO71GKS0028(C)-PA
.....	\$605/pr.
Coupe Front Panels (Unassembled)	DO71GKS0020(C)
.....	\$459/pr.
(Pre-assembled) ^{OS1}	DO71GKS0020(C)-PA
.....	\$638/pr.
Sport Coupe Rear Panels (Unassembled)	DO71GKS0080(C)
.....	\$317/pr.
(Pre-assembled) ^{OS1}	DO71GKS0080(C)-PA
.....	\$456/pr.
Coupe Rear Panels (Unassembled)	DO71GKS0088(C)
.....	\$317/pr.
(Pre-assembled) ^{OS1}	DO71GKS0088(C)-PA
.....	\$483/pr.
Sport Coupe Armrest/Well Covers	AW68GA00048(C)
(Unassembled)	\$78/pr.

This Legendary product features as-original Die-electrically heat sealed Madrid grain vinyl with chrome accent strip. Special cutout area in filler board to accommodate armrest base. Padded Multi-Level Construction 3-Dimensional Panel.

NOTE: Customer must reuse original decorative trim and medallions. Medallions are available. See following section of catalog.

1972 SKYLARK, SKYLARK CUSTOM & GRAN SPORT



(C) COLOR CODES:

- (100G) Black
- (230G) White
- (670G) Tan
- (690G) Saddle
- (695G) NOS Sandalwood

Front Panels (Unassembled)	DO72GKD0012(C)
100G, 230G, 670G, 690G	\$525/pr.
695G	\$858/pr. (L1)
(Pre-assembled) ^{OS1}	DO72GKD0012(C)-PA
100G, 230G, 670G, 690G	\$693/pr.
695G	\$1087/pr. (L1)
☞ Please refer to carpet color selection page to specify carpet color at time of order.	
☞ Customer must reuse original metal trim.	
Sport Coupe Rear Panels (Unassembled)	DO72GKD0048(C)
100G, 230G, 670G, 690G	\$276/pr.
695G	\$456/pr. (L1)
(Pre-assembled) ^{OS1}	DO72GKD0048(C)-PA
100G, 230G, 670G, 690G	\$495/pr.
695G	\$649/pr. (L1)
☞ Customer must reuse original metal trim.	
Sport Coupe Armrest/Well Covers	AW68GA00048(C)
100G, 230G, 670G, 690G	\$78/pr.
695G	\$174/pr. (L1)

This Legendary product features as-original Die-electrically heat sealed Madrid grain vinyl with woodgrain center insert and carpeted lower section. Special cutout area in filler board to accommodate armrest base. Padded Multi-Level Construction 3-Dimensional Panel.

NOTE: Customer must reuse original decorative trim and medallions. Medallions are available. See following section of catalog.

1964-72 ARMREST PADS

Reproduction molded armrest pads are manufactured in the correct grains and texture as the originals. 1964 pads feature Seville grain, while 1965-72 feature authentic Madrid grain. For colors other than black, please specify at time of order.

1964-72 FRONT PADS



1964-67 Skylark & Gran Sport (Coupe)

AP64GA-FRT (1964)

100G, 220G, 325G, 334G, 405G, 508G, 656G\$101.00/pr.

AP65GA-FRT (1965-67)

100G, 220G, 240G, 310G, 325G, 343G, 420G, 448G, 501G, 520G, 640G, 650G\$101.00/pr. 679G\$147.00/pr. (L1)

☞ These pads measure 11" in length.

☞ Please refer to door panel section for available colors.

1968-72 Skylark & Gran Sport

AP68GA-FRT

100G, 202G, 220G, 230G, 235G, 239G, 325G, 333G, 342G, 460G, 502G, 503G, 658G, 670G, 683G, 690G, 694G, 695G, 697G, 709G, 710G\$101.00/ea. 135G\$147.00/ea. (L4)

☞ These pads measure 11" in length.

☞ Please refer to door panel section for available colors.

1968-70 Skylark & Gran Sport

AP68GKU-FRT01 (Black)\$159.00/pr.

☞ These pads measure 16" in length.

☞ Available in black only.

1964-69 REAR PADS



1964 Skylark & Gran Sport (Coupe)

AP64GA-RR

100G, 220G, 325G, 334G, 405G, 508G, 656G\$101.00/pr.

☞ Please refer to door panel section for available colors.

☞ Sport Coupe & Coupe models only.

1965 Skylark & Gran Sport (Coupe)

AP65GA-RR

100G, 220G, 240G, 310G, 325G, 343G, 420G, 448G, 501G, 520G, 640G, 650G, 679G\$101.00/pr. 679G\$147.00/pr. (L1)

☞ Coupe models only.

1968-69 Skylark & Gran Sport (Coupe)

AP68GA-RR

100G, 220G, 235G, 239G, 325G, 333G, 502G, 503G, 658G, 709G, 710G\$92.00/ea. 135G\$147.00/ea. (L4)

☞ Please refer to door panel section for available colors.

☞ Sport Coupe & Coupe models only.

1964-72 REAR ARMREST COVERS

Rear armrest covers for Holiday Coupe, Hard-top Coupe and Convertible models are made in-house to original specifications and feature the correct vinyl colors and grains to match our upholstery. Please specify color at time of order.



COUPE MODELS

1964 Skylark

AW64GA00048(C)\$78.00/set

☞ Please see door panel section for available colors.

1965-67 Skylark & Gran Sport

AW65GA00048(C)\$78.00/set

☞ Please see door panel section for available colors.

1968-72 Skylark & Gran Sport

AW68GA00048(C)\$78.00/set

☞ Please see door panel section for available colors.

CONVERTIBLE MODELS

1964 Skylark

AW64GA00056(C)\$96.00/set

☞ Please see door panel section for available colors.

1965 Skylark & Gran Sport

AW65GA00056(C)\$96.00/set

☞ Please see door panel section for available colors.

1966-67 Skylark & Gran Sport

AW66GA00056(C)\$96.00/set

☞ Please see door panel section for available colors.

1968-72 Skylark & Gran Sport

AW68GA00056(C)\$96.00/set

☞ Please see door panel section for available colors.

1964-67 ARMREST BASES

Chrome armrest bases are original-style injection molded plastic. Triple chrome plated, these are of a superior quality than others on the market. Available in pairs for both front and rear.

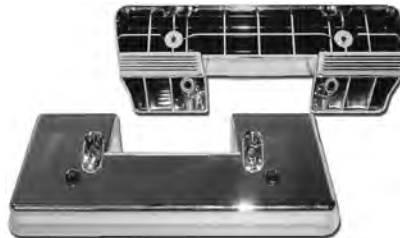

1964-65 Skylark & Gran Sport (Coupe)

AP64GA-BASEFRT (Front) (shown)\$49.00/pr.

☞ Uses 11" armrest pads.

1964-65 Skylark & Gran Sport (Coupe)

AP64GA-BASERR (Rear)\$49.00/pr.

☞ Fits all coupe models.

1968-72 ARMREST BASES

High-quality reproduction injection molded plastic bases have the original texture and grain as the originals.



1968-72 Skylark & Gran Sport

AP68GAF-BASELH (Left Front)\$29.00/ea.

AP68GAF-BASERH (Right Front)\$29.00/ea.

☞ Measure 11" in length.

☞ Use with 11" armrest pads.

1969-72 ARMREST BASE CHROME BACK PLATE

Chrome back plates found on some, but not all, 1969-72 models. Factory exact and ready to install. Will not work for 1968 models.



1969-72 Skylark & Gran Sport

AP69GA-BASECHR (Front)\$49.00/pr.

☞ Use with 11" armrest bases shown above.

1968-72 ARMREST BASE SCREW SET

These Phillips head sheet metal screws fasten the armrest base to the door. Set of (6).

1968-72 Skylark & Gran Sport

AP68GA-SCREW (Set/6)\$9.00/set



ASHWELL INSTALLATION PAD KITS

Ashwell installation pad kits for 1964-72 Skylark & GS Hardtop and Convertible models.



1964-67 Skylark & GS (hardtop)
INSTALLATION-AW1.....\$39.00/kit
 ☞ Kit includes: (2) 20oz. board w/ 5oz. felt attached,
 (2) 20oz. felt & (2) 40oz. felt



1968-72 Skylark & GS (hardtop)
INSTALLATION-AW3.....\$39.00/kit
 ☞ Kit includes: (2) 20oz. board w/ 5oz. felt attached,
 (2) 20oz. felt & (2) 40oz. felt



1964-67 Skylark & GS (convertible)
INSTALLATION-AW2.....\$39.00/kit
 ☞ Kit includes: (2) 20oz. board w/ 5oz. felt attached,
 (2) 5oz. felt & (2) 20oz. felt



1968-72 Skylark & GS (convertible)
INSTALLATION-AW4.....\$39.00/kit
 ☞ Kit includes: (2) 20oz. board w/ 5oz. felt attached,
 (2) 5oz. felt & (2) 20oz. felt

1964-72 CONVERTIBLE COURTESY LIGHT LENS & BEZELS



These quality reproduction lens and bezels mount to the rear armrest on convertible models. The lens is reproduced in the correct "eggshell" white while the bezel is manufactured using NOS tooling.

1964-72 Skylark & Gran Sport
LL64GA-CBEZEL (Bezel only).....\$29.00/ea.
LL64GA-CLENS (Lens only).....\$10.00/ea.

1964-72 ASHTRAYS

These ashtrays are constructed from stainless steel and fit just like the originals. Available for both hardtop and convertible models.



1964-67 Skylark & Gran Sport
AT64GA-C (Hardtop/Convertible)\$59.00/pr.
 ☞ Bezels included for convertible models.
1968-70 Skylark & Gran Sport
AT68GA-C (Convertible)\$49.00/ea.
1968-72 Skylark & Gran Sport (shown)
AT68GA-H (Hardtop)\$59.00/ea.

HINGE TO DOOR BOLTS



Made to exact GM specifications for proper fit.

1968-72 Skylark & Gran Sport
DO68GA-BOLTS.....\$49.00/set

1968-69 STAINLESS ARMREST BASE MOLDING

Factory-correct armrest molding found on some, but not all 1968-69 models.

1968-69 Skylark & Gran Sport
AP68GA-BASETRIM\$49.00/pr.
 ☞ Holes will need to be drilled on bases for installation.

1968-69 DOOR PANEL WINDLACE



Made as original with Madrid grain vinyl, rubber cord and die-cut panel board. This windlace installs on the front edge of the rear quarter panels and is a decorative and functional wind seal. Made as original for both post, non-post and convertible models. Please specify color at time of order.



1968-69 Skylark & Gran Sport
WI68GA00047(C) (Coupe)..... \$93.00/pr.
WI68GA00048(C) (Sport Cpe/Conv.)..... \$93.00/pr.

1964-67 UPPER DOOR JAMB END CAPS

Exact reproduction endcaps screw to the upper door jamb and give that finished look by covering the end of the windlace seal. Available in black only.



1964-65 Skylark & Gran Sport
WI64GA-CAPH (Coupe/Sport Coupe) .. \$39.00/pr.
WI64GA-CAPC (Convertible)..... \$39.00/pr.

1966-67 Skylark & Gran Sport
WI66GA-CAPHC..... \$29.00/pr.
 Fits both hardtop and convertible models.

1964-67 DOOR JAMB WINDLACE



This quality replacement molded windlace features the original bumpy grain vinyl with the steel insert to clip to the door jamb edge lip. Available in black, lt. blue, dk. blue, fawn, saddle, (64) red, (65-67) red and white. Please specify color at time of order.

1964-67 Skylark & Gran Sport
WI64GA(C) (Coupe models) \$49.00/pr.
 Will also work for convertible models.

DOOR LOCK KNOBS



Complete your door trim restoration with new door lock knobs. Available in black or chrome.

1964-66 Skylark & Gran Sport
BT64GA (Chrome)..... \$15.00/pr.

1967 Skylark & Gran Sport
BT67GA (Chrome w/ "tuliped" head).... \$15.00/pr.

1968-72 Skylark & Gran Sport (shown)
BT68GA (Chrome w/ ribbed shaft)..... \$19.00/pr.

DOOR LOCK FERRULES

Authentically reproduced ferrules support the door lock knob.



BT64GAFERRULE

BT68GAFERRULE

1964-67 Skylark & Gran Sport
BT64GAFERRULE (Clear plastic) \$9.00/pr.

1968-72 Skylark & Gran Sport
BT68GAFERRULE (Stainless steel).... \$2.00/ea.
 These ferrules feature the correct inner felt ring as original.

DOOR PANEL CLIPS



Original style door panel installation clips.

1964-72 Skylark & Gran Sport
DOGACLIPS \$14.00/kit
 Kit includes 18 clips and 12 trim screws which are enough to install a pair of door and rear quarter panels.

DOOR PANEL CLIP RETAINERS



Plastic retainers fit into the inner door and quarter panel frame to act as anchors for the metal door panel clips.

1964-72 Skylark & Gran Sport
DOGARETAIN (Pkg/12)..... \$10.00/pk.



DOOR HANDLES



Chrome reproduction inner door handle for 1964 Coupe models that use an 11" armrest pad.

1964 Skylark
CK64GA-DOOR \$29.00/ea.



Chrome reproduction inner door handle for 1964-67 Sport Coupe and Convertible models that use a 13 1/2" armrest pad.

1964-67 Skylark & Gran Sport
CK64GUK-DOOR \$59.00/pr



Chrome reproduction inner door handle for 1965-67 Coupe models that use an 11" armrest pad.

1965-67 Skylark & Gran Sport
CK65GA-DOOR \$19.00/ea.



Chrome reproduction inner door handles for 1968-72 models.

1968-72 Skylark & Gran Sport (all models)
CK68GA-DOORLH (Left) \$19.00/ea.
CK68GA-DOORRH (Right) \$19.00/ea.

WINDOW CRANK HANDLES



Die-cast reproduction of the original front and rear window crank handle for all 1964 models.

1964 Skylark
CK64GA-WNDW (Black knob) \$29.00/ea.



Die-cast reproduction of the original chrome front and rear window crank handle for all 1965-66 models.

1965-66 Skylark & Gran Sport
CK65GA-WNDW (Chrome knob) \$19.00/ea.



Die-cast reproduction of the original chrome front and rear window crank handle for all 1967-72 models.

1967-72 Skylark & Gran Sport
CK67GA-WNDW01 (Black knob) \$15.00/ea.
CK67GA-WNDW02 (Clear knob) \$15.00/ea.



Duplicated to exact GM specifications with a brilliant chrome finish. These die-cast vent handles come with roll pins and spring washers.

1964-65 Skylark & Gran Sport
CK64GA-VENTLH (Left) \$29.00/ea.
CK64GA-VENTRH (Right) \$29.00/ea.

1966-67 Skylark & Gran Sport
CK66GA-VENT \$49.00/pr.

1968-72 VENT WINDOW CRANKS



Reproduction vent window cranks for all 1968 models and 1969-72 Coupe models with vent windows.

1968-72 Skylark & Gran Sport
CK68GA-VENT01 (Black) \$19.00/ea.
CK68GA-VENT02 (Clear) \$19.00/ea.

DOOR & WINDOW HANDLE PLASTIC WASHER



Injection molded plastic washers protect the door panel from wear when door and window handles are being used.

1964-72 Skylark & Gran Sport
CK64GA-SPACER \$3.00/ea.

WINDOW HANDLES SPRINGS



This spring goes behind the window crank handle and plastic washer to prevent vibration and rattling.

1964-72 Skylark & Gran Sport
CK64GA-SPRING \$3.00/ea.

DOOR & WINDOW HANDLE RETAINING CLIP



1964-72 Skylark & Gran Sport
CK64GA-CLIP \$1.00/ea.

DOOR LOCK STRIKER



These door strikers feature the same hardened steel as the originals and should be used to replace damaged or fatigued originals.

1964-72 Skylark & Gran Sport NEW!!!
DO64GA-STRIKER..... \$19.00/ea.

UPPER DOOR HINGES



These are OEM-quality hinges and are made to factory specifications. They are fantastic reproductions of the original hinges and they're completely assembled for easy installation.

1966-67 Skylark & Gran Sport (shown) NEW!!!
DO66GA-HINGEU..... \$59.00/ea.

1968-72 Skylark & Gran Sport NEW!!!
DO68GA-HINGEU..... \$89.00/ea.

LOWER DOOR HINGES



These are OEM-quality hinges and are made to factory specifications. They are fantastic reproductions of the original hinges and they're completely assembled for easy installation.

1966-67 Skylark & Gran Sport NEW!!!
DO66GA-HINGELP (passenger) \$79.00/ea.
DO66GA-HINGELD (driver)..... \$79.00/ea.

1968-72 Skylark & Gran Sport NEW!!!
DO68GA-HINGELP (passenger) \$89.00/ea.
DO68GA-HINGELD (driver)..... \$99.00/ea.

LOWER DOOR HINGE PINS

Hardened shouldered pivot pins



1964-67 Skylark & Gran Sport NEW!!!
DO64GA-HINGEPIN \$8.00/ea



1968-72 Skylark & Gran Sport NEW!!!
DO68GA-HINGEPIN \$10.00/ea

LOWER DOOR SPRING



Direct replacement for missing or broken door hinge springs. Same size and spring rate as original part.

1965-67 Skylark & Gran Sport NEW!!!
DO65GA-SPRING..... \$15.00/ea.

DOOR SILL PLATES



Replace old scratched-up sill plates with a pair of these exact reproductions. Precision manufactured using the correct aluminum and anodized finish featuring the "Body by Fisher" tags.
 * Does not come with screws, must supply own.

1964-67 Skylark & Gran Sport
SP64GA \$79.00/pr.

1968-72 Skylark & Gran Sport
SP68GA \$99.00/pr.

DOOR PANEL EMBLEMS

Emblem is chromed and detailed just like the original for a factory look.



1970 Gran Sport (Deluxe)
DO70GK-EMBLEM..... \$29.00/ea.



1968-72

1970-72 Gran Sport
DO71GK-EMBLEM..... \$39.00/ea.

For 1970 GS models with standard interiors.
 All 1971-72 GS Models

DOOR PANEL WATERSHIELDS

Die-cut watershields are designed to protect your door panels from moisture. Sold as a complete set of 4 for front and rear panels.

1964-67 Skylark & Gran Sport
DO64GAWATERH (Hardtop)\$37.00/set
DO64GAWATERC (Convertible).....\$37.00/set

1968-72 Skylark & Gran Sport
DO68GAWATERHS (1968-69 Sport Cpe) ..\$37.00/set
DO68GAWATERH (1970-72 Sport Cpe) ..\$37.00/set
DO68GAWATERS (1968-72 Coupe)....\$37.00/set
DO68GAWATERC (Convertible).....\$37.00/set

SEAT BELT BOLTS



1964-66 Chrome Plated 1964-66 Cad Plated 1967-72 Chrome Plated

The bolt heads are the factory-sized 13/16" and fit and function just like the originals and come in either a cad-plated or chrome finish.

1964-72 Skylark & Gran Sport NEW!!!
BA64GA-BOLT (Chrome).....\$15.00/ea.
BA64GA-BOLTC (Cad).....\$15.00/ea.
BA67GA-BOLT (Chrome).....\$15.00/ea.

JUTE BACKING

This insulating material when placed between the floorpan and molded carpet enhances sound barrier protection from road noise and adds cushion to your carpet. Also helpful for insulating headliners, trunk areas and more.





36"x36" cut



TA200ZFELT (20 oz.).....\$10.00/yd.
TA400ZFELT (40 oz.).....\$15.00/yd.





CARPETS, FLOORMATS AND ACCESORIES

 facebook.com/legendaryautointeriors
 twitter.com/legendaryautoin

 www.legendaryautointeriors.com
 instagram.com/legendaryautointeriorsltd
 youtube.com/user/legendaryauto



MODEL SPECIFIC CARPET

Legendary brand molded carpets utilize the heaviest face weight cutpile and loop carpet combined with an extra heavy poly coated backing that provides for an accurate and sharply detailed mold formed area. Surged edges and accurately die cut and applied 40oz. felt underlayment is the finishing touch to our vehicle specific carpets.

Bound and Surged Edges

Both Legendary cutpile and loop molded carpets have a heavy duty bound and surged edge that provides for an easy installation and clean appearance.



Underlayment Padding

Legendary molded carpets are made with a 40 oz. felt underlayment padding. All padding is trimmed around seat track mounts, seat belt holes and covers the most area than any carpet in the industry!



80/20 Loop CARPET COLOR SELECTOR (c)

01 BLACK	03 RED	04 AQUA	05 DARK TEAL	06 FORD BLUE	07 DARK BLUE	08 TEAL	09 SHADE 13 BLUE
10 BRIGHT BLUE	11 MEDIUM BLUE	12 GREEN	13 DARK GREEN	14 DARK OLIVE GREEN	15 BLUE GREEN	16 MOSS GREEN	21 MEDIUM RED
22 BURNT ORANGE	24 ROSE BEIGE	25 DARK BROWN	26 SADDLE	27 LT/MEDIUM SADDLE	28 DARK COPPER	29 DARK SADDLE	31 MAROON
32 GOLD	33 DARK GOLD	34 FAWN	35 RED TUXEDO	36 BLUE TUXEDO	37 AQUA TUXEDO	38 LIGHT GREEN	39 ORANGE
40 PLUM	41 SUNSET GLOW	42 SILVER MINK	44 CORAL	45 EMBER GLOW	46 IVY GOLD	47 FAWN TUXEDO	48 SILVER
49 GUNMETAL GRAY	50 PARCHMENT	51 MIDNIGHT BLUE	53 GOLD TUXEDO	54 COPPER TUXEDO	55 OLIVE TUXEDO	81 CHARCOAL	

****36oz. JUTE PADDING INCLUDED WHERE PADDING WAS ORIGINAL.**

****VINYL BOUND EDGE WHERE THE FRONT AND REAR SECTIONS OF THE CARPET OVERLAP.**

****COLOR MATCHED ORIGINAL HEEL PAD ACCURATELY APPLIED USING THE SAME METHOD AS OEM.**

****MEETS OR EXCEEDS OEM SPECIFICATIONS.**

****DIMMER SWITCH GROMMET INCLUDED.**

****COLOR SAMPLES ARE AVAILABLE FOR COLORS OTHER THAN BLACK.**

****DYE LOTS WILL VARY +/- 10%. THIS IS COMMON IN THE CARPET INDUSTRY. CUSTOMERS ARE ENCOURAGED TO ORDER ALL CARPETED PRODUCTS AT THE SAME TIME TO ENSURE MATCHING DYE LOT.**

****FOR YEARS AND MODELS NOT LISTED PLEASE CALL OUR SALES DEPARTMENT AT 800-363-8804**

CARPET (NYLON LOOP)

The finest available today. Two-piece pre-molded shape made with an original specification blend of 100% Nylon. All carpets include 36oz. jute padding on the back-side, dimmer switch grommet, color matched original style heel pad and vinyl bound edge where the front and rear sections overlap. Carpet kits are not shipped with pre-cut holes. This must be done during installation of carpet. Some other minor trimming may be needed. For years and models not listed please call our sales department for more information. We are able to get carpet kits for many other Buick models and years not shown.

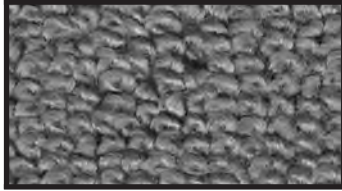
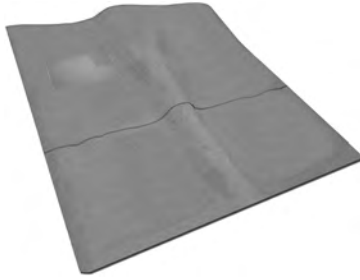

Loop Style

1964-67 Skylark & Gran Sport
CA64GKA(C) (2-door/Automatic).....\$195.00/ea.
CA64GKS(C) (2-door/Manual).....\$195.00/ea.

1968-72 Skylark & Gran Sport (shown)
CA68GKA(C) (2-door/Automatic).....\$195.00/ea.
CA68GKS(C) (2dr. Manual w/o console) ..\$195.00/ea.
CA68GKSW(C) (2dr. Manual w/ console).....\$195.00/ea.

KICK PANEL CARPET

Kick panel carpet kits made of nylon loop style carpeting and vinyl trim binding. Please specify with or without A/C, with or without fresh-air vent(s) and color of carpet and vinyl binding at time of order.

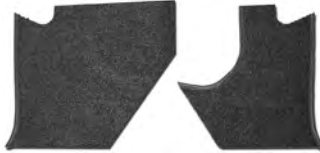

1964 Skylark (all models)
KI64GAW/O(C)
 (with fresh air vents & no A/C).....\$65.00/pr.
KI64GAW/AF(C)
 (with driverside fresh air vent & A/C).....\$65.00/pr.

1964 Skylark (all models)
KI64GAW/A(C)
 (with A/C & no fresh air vent).....\$65.00/pr.

1965-66 Skylark & Gran Sport (all models)
KI65GAW/O(C)
 (with fresh air vents & no A/C).....\$65.00/pr.
KI65GAW/AF(C)
 (with driverside fresh air vent & A/C).....\$65.00/pr.

1965-67 Skylark & Gran Sport (all models)
KI65GAW/A(C)
 (with A/C & no fresh air vent).....\$65.00/pr.

1967 Skylark & Gran Sport (all models)
KI67GAW/O(C)
 (with fresh air vents & no A/C).....\$65.00/pr.
KI67GAW/AF(C)
 (with driverside fresh air vent & A/C).....\$65.00/pr.

1968 Skylark & Gran Sport (all models)
KI68GAW/O(C) (w/o A/C).....\$65.00/pr.

1968-72 Skylark & Gran Sport (all models)
KI68GAW/A(C) (with A/C) (shown)\$65.00/pr.

1969-72 Skylark & Gran Sport (Sport Cpe. & Conv.)
KI69GAW/O(C) (w/o A/C).....\$65.00/pr.

1969-72 Skylark & Gran Sport (Coupe)
KI69GASW/O(C) (w/o A/C).....\$65.00/pr.

KICK PANELS



Reproduction plastic kick panels made for models with factory air conditioning. These will also fit non-air conditioning models, but do not have the fresh-air outlet vents. Available in black only.

1964 Skylark
KI64GA100.....\$159.00/pr.

1965-66 Skylark & Gran Sport
KI65GA100.....\$159.00/pr.

1967 Skylark & Gran Sport
KI67GA100 (shown).....\$159.00/pr.

1968-72 Skylark & Gran Sport
KI68GA100.....\$149.00/pr.

KICK PANEL INSULATION

Die-cut jute insulation pads fit between the plastic kick panel and the body sheet metal to protect from moisture.

1964-67 Skylark & Gran Sport
KI64GA.....\$15.00/pr.

1968-72 Skylark & Gran Sport
KI68GA.....\$15.00/pr.

CARPET YARDAGE

Need additional carpet?
 We offer carpet yardage in 1yd. and 2yd. cuts. Please specify color at time of order. We highly recommend purchasing extra yardage along with your carpet kit to ensure color match.



Loop Carpet
CAYD(C) (1 yard)\$79.00/yd.
 For colors other than black please refer to color code list located at the top of this page.

SOUND DEADENER

This heavyweight material installs under the carpet directly against the floorpan to reduce heat and noise. Pre-cut to correct shape and size.

1964-67 Skylark & Gran Sport
SD64GA.....\$99.00/ea.

1968-72 Skylark & Gran Sport
SD68GA.....\$99.00/ea.

SOUND DAMPENING

Kits are designed on current "state-of-the-art" auto acoustic technology, to insulate and control the noise, vibration and heat.

1964-65 A-Body Hardtop/Coupe Models

SD64GA-H (Dampening Kit).....\$949.00/ea.
 Kit includes Body Panel, Cowl, Floor, Roof & Trunk pieces.
SD64GA-BPK (Body Panel).....\$189.00/ea.
SD64GA-CK (Cowl).....\$129.00/ea.
SD64GA-FK (Floor).....\$339.00/ea.
SD64GA-RK (Roof).....\$189.00/ea.
SD64GA-TK (Trunk).....\$189.00/ea.

1964-65 A-Body Convertible Models

SD64GA-V (Dampening Kit).....\$829.00/ea.
 Kit includes Body Panel, Cowl, Floor & Trunk pieces.
SD64GA-VBPK (Body Panel).....\$189.00/ea.
SD64GA-VCK (Cowl).....\$129.00/ea.
SD64GA-VFK (Floor).....\$339.00/ea.
SD64GA-VTK (Trunk).....\$189.00/ea.

1966-67 A-Body Hardtop/Coupe Models

SD66GA-H (Dampening Kit).....\$949.00/ea.
 Kit includes Body Panel, Cowl, Floor, Roof & Trunk pieces.
SD66GA-BPK (Body Panel).....\$189.00/ea.
SD66GA-CK (Cowl).....\$129.00/ea.
SD66GA-FK (Floor).....\$339.00/ea.
SD66GA-RK (Roof).....\$189.00/ea.
SD66GA-TK (Trunk).....\$189.00/ea.

1966-67 A-Body Convertible Models

SD66GA-V (Dampening Kit).....\$829.00/ea.
 Kit includes Body Panel, Cowl, Floor & Trunk pieces.
SD66GA-VBPK (Body Panel).....\$189.00/ea.
SD66GA-VCK (Cowl).....\$129.00/ea.
SD66GA-VFK (Floor).....\$339.00/ea.
SD66GA-VTK (Trunk).....\$189.00/ea.

1968-72 A-Body Hardtop/Coupe Models

SD68GA-H (Dampening Kit).....\$999.00/ea.
 Kit includes Body Panel, Cowl, Floor, Roof & Trunk pieces.
SD68GA-BPK (Body Panel).....\$189.00/ea.
SD68GA-CK (Cowl).....\$129.00/ea.
SD68GA-FK (Floor).....\$339.00/ea.
SD68GA-RK (Roof).....\$189.00/ea.
SD68GA-TK (Trunk).....\$189.00/ea.

1968-72 A-Body Convertible Models

SD68GA-V (Dampening Kit).....\$829.00/ea.
 Kit includes Body Panel, Cowl, Floor & Trunk pieces.
SD68GA-VBPK (Body Panel).....\$189.00/ea.
SD68GA-VCK (Cowl).....\$129.00/ea.
SD68GA-VFK (Floor).....\$339.00/ea.
SD68GA-VTK (Trunk).....\$189.00/ea.





Providing the automotive industry
with the world's highest quality
soft trim products and services
RIGHT HERE AT HOME

**STILL ASSEMBLED AND
MADE IN THE** ★★★★★
USA 

THERE REALLY IS A DIFFERENCE!!

Legendary
AUTO INTERIORS LTD.

www.legendaryautointeriors.com





LEGENDARY'S CUSTOM VINTAGE RUBBER STYLE FLOORMATS

DESIGNED TO FIT WHOLE FLOORPAN OF CAR LOGOS ON FRONT AND REAR MATS

How many times have you wished for automotive floormats that have custom-fit floopan shapes, that are easily cleanable and also have that "factory original" styling that would make you proud to display them in your classic car? Our "Custom Vintage" rubber style floormats will please the most discriminating buyer and provide years of carefree use.



www.legendaryautointeriors.com

CUSTOM DESIGN FLOORMATS

AVAILABLE IN ALL YEARS,
MAKES AND MODELS



Challenger
R/T

1 Color
insert

Adds \$25 to base price



Challenger
R/T

2 Color
insert

Adds \$50 to base price



Challenger
R/T

3 Color
insert

Adds \$75 to base price

DESIGN YOUR OWN
INSERTS & COLORS

www.legendaryautointeriors.com



FLOORMAT BASE & INSERT COLORS

BASE COLORS

001 Black - 007 Dark Blue - 011 Medium Blue - 018 Bright Red - 020 Red - 023 Tan - 031 Maroon
 033 Dark Gold - 037 Aqua - 050 Turquoise - 057 Dk Olive Green - 079 Gray
 098 Brown - 129 Dark Saddle - 132 Gold - 148 Silver Grey

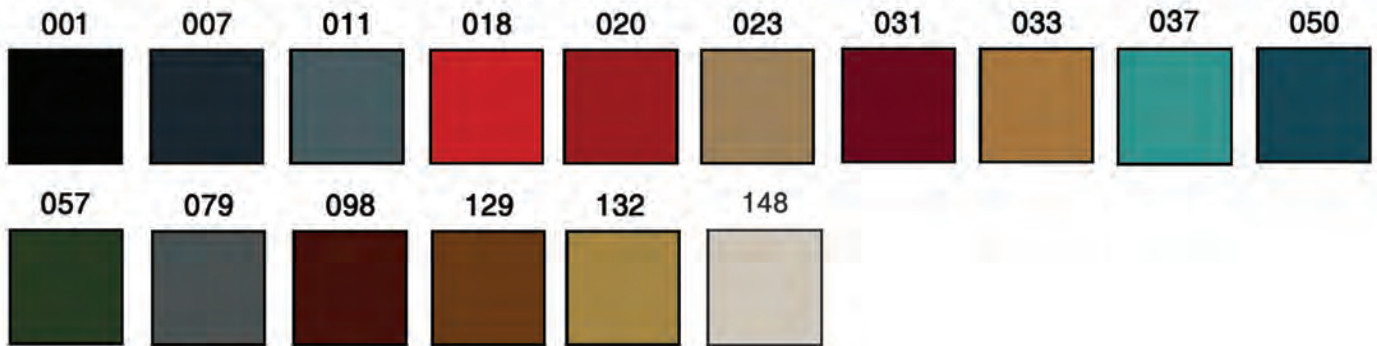

INSERT COLORS

133 Cream - 134 Sandalwood - 137 Aztec Gold - 138 Buckskin - 139 Sienna - 141 Coffee Bean - 142 Football - 143 Basketball
 150 Lemon Twist - 151 Mellow Yellow - 153 Precious Purple - 154 Plum Crazy - 155 Moody Blue - 156 Sky Blue
 157 Light Blue - 159 Pacific Blue - 160 Caribbean Blue - 161 Royal Blue - 163 Navy Blue - 164 Groovy Blue
 165 Sassy Grass - 166 Pine - 167 Mint Green - 168 Hunter Green - 169 Antique Green - 170 Aqua Marine - 171 Mango
 172 Awesome Orange - 173 Sunset Orange - 174 Panther Pink - 175 Radical Red - 176 Cherry Red - 177 Cranberry
 178 Razzberry - 179 Garnet - 180 Smoke - 181 Platinum - 182 Medium Grey - 183 Silver - 184 Charcoal

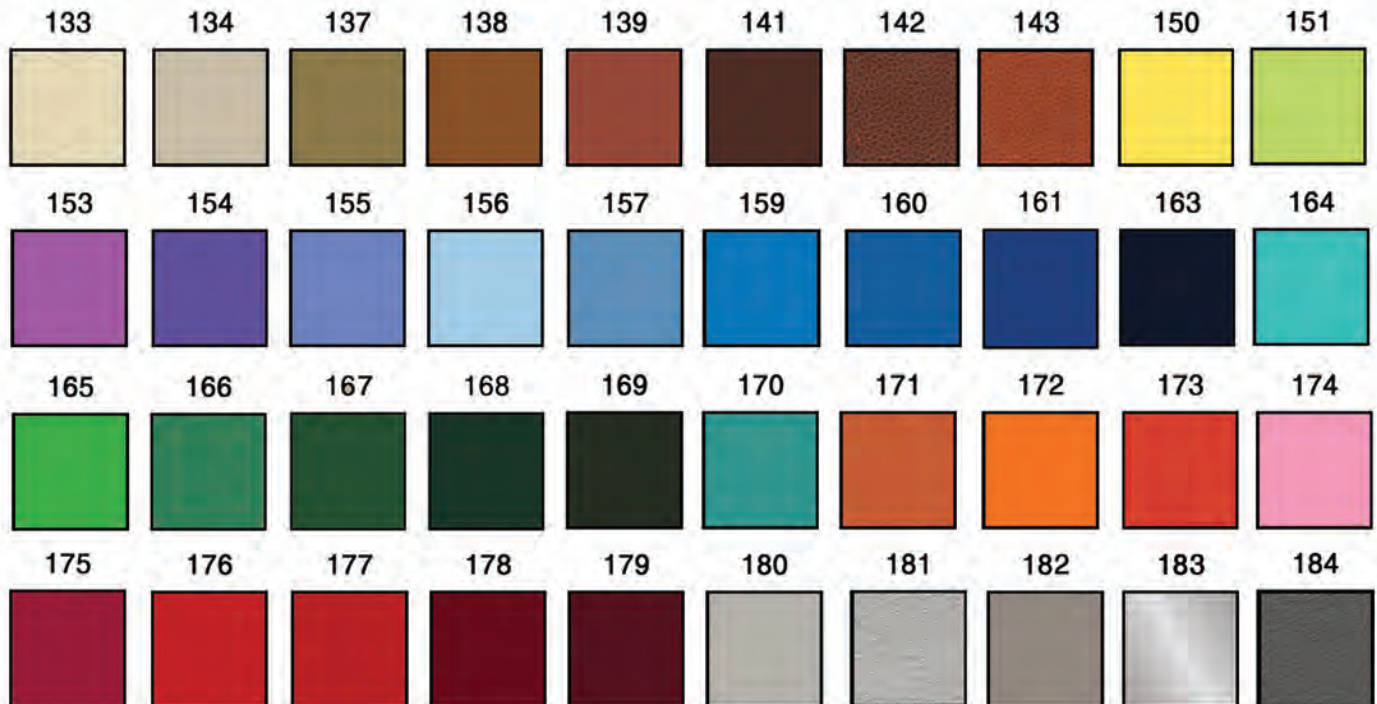

***Note - To order mats with colored inserts please call our sales department**

Actual colors will vary from samples on this page. Contact our Sample Request Department for actual color samples at 1-800-363-8804 or send us an email through our Sample Request Center on our website at www.legendaryautointeriors.com



1964-72 BUICK SKYLARK & GRAN SPORT

GS
455

SURE-GRIP™
CONYK ANTI-SKID BACKING

gm RESTORATION

1964-65 Special - Script letters
FMSK0001003(C) - Automatic

1966-67 Special - Block letters
FMSK0001004(C) - Automatic

1964-66 Skylark - Script letters
FMSK0001005(C) - Automatic

1967 Skylark - Script letters
FMSK0001006(C) - Automatic

1965 Gran Sport - Block letters w/ Buick logo
FMGS0001002(C) - Automatic

1966 Gran Sport - Block letters
FMGS0001003(C) - Automatic

1967 Gran Sport - GS 340 w/ Buick logo
FMGS0001004(C) - Automatic

1967 Gran Sport - GS 400 w/ Buick logo
FMGS0001005(C) - Automatic

1967 Gran Sport - GS by Buick
FMGS0001006(C) - Automatic

1968-69 Skylark Custom - Script letters
FMSK0002001(C) - Automatic

1968-72 Skylark - Script letters w/ Buick logo
FMSK0002003(C) - Automatic

1970-72 Skylark Custom - Script letters
FMSK0002004(C) - Automatic

1970-72 Skylark 350 - Script letters
FMSK0002005(C) - Automatic

1968-69 Gran Sport - GS 400 w/ Buick logo
FMGS0002001(C) - Automatic

1968-72 Gran Sport - GS by Buick
FMGS0002003(C) - Automatic

1968-69 Gran Sport - GS 350 w/ Buick logo
FMGS0002004(C) - Automatic

1968-69 Gran Sport - GS California w/ Buick Logo
FMGS0002005(C) - Automatic

1970-72 Gran Sport - GS 455
FMGS0002006(C) - Automatic

1970-72 Gran Sport - GS Stage 1
FMGS0002007(C) - Automatic

1970-72 GSX - GSX Logo
FMGS0002008(C) - Automatic

FLOORMAT PRICING:
ALL COLORS - \$189.00/set

1964-65 Special



1966-67 Special



1964-66 Skylark



1967 Skylark



1965 Gran Sport



1966 Gran Sport



1967 GS 340



1967-69 GS 400



1967-72
GS by Buick



1968-69 Skylark



1968-72 Skylark



1970-72 Skylark Custom



1970-72 Skylark 350



1968-69 GS 350



1968-69 GS California



1970-72 GS 455



1970-72 GS Stage 1



1970-72 GSX



ORIGINAL STYLE BUICK & CORVETTE

SURE-GRIP™
CORVETTE ANTI-SKID BACKING



1964-72 Buick
FMOR64GK(C)

FLOORMAT PRICING:
ALL COLORS - \$299.00/set



SURE-GRIP™
CORVETTE ANTI-SKID BACKING



1963-67 Corvette
FMOR65GV(C)

FLOORMAT PRICING:
ALL COLORS - \$149.00/set



FLEX TREAD®

YOU ASK FOR IT...WE DELIVERED!!



PINK COMING
2023!



YOU ASK FOR IT...WE DELIVERED!!

PATENTED

SCENERY MATS

VERSAFIT™ TRIM-TO-FIT MATS

**MANY KOOL SCENES AVAILABLE
AND MORE COMING SOON!**

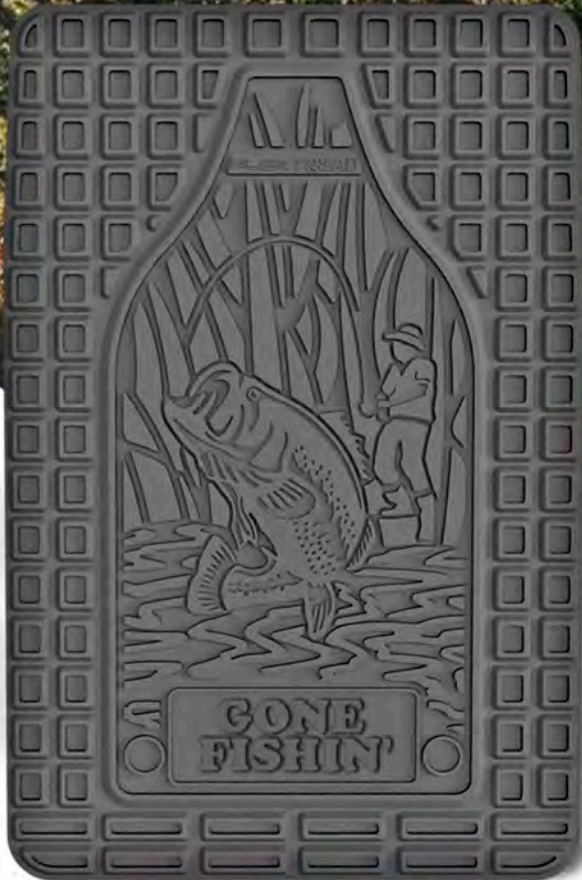

FISHING SCENE

BOOTMATS



DUCK SCENE

SCENERY AVAILABLE ON VERSAFIT™ & BOOTMATS



WHITETAIL SCENE



EQUINE SCENE



**SCORCHED EARTH &
TIRE TRACK SCENE**

Versafit™

Trim-To-Fit Mats

CHOOSE
YOUR
SCENE

VERSAFIT™ universal trim-to-fit floor mats fit most domestic and foreign vehicles. Mats can be cut to fit your vehicle's unique floorpan. Includes manual screw in style safety retention positioning posts for installation.



Bootmats

CHOOSE
YOUR
SCENE

"Fun"ctional Boot Mats from FLEXTREAD bring a KOOL look inside while leaving the mess at the door. Featuring scenery and measuring finished size 16" tall by 28" wide.



FLOORMAT & BOOTMAT COLORS



001 - Black



007 - Dark Blue



011 - Medium Blue



018 - Bright Red



020 - Red



023 - Tan



031 - Maroon



050 - Turquoise



057 - Dark Olive Green



074 - Pink



079 - Grey

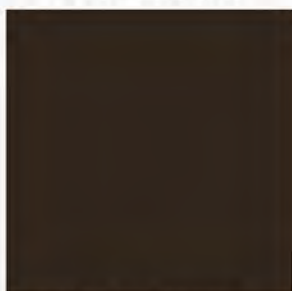

098 - Brown



129 - Dark Saddle



132 - Gold

CAMOUFLAGE



200 - Rugged Woods

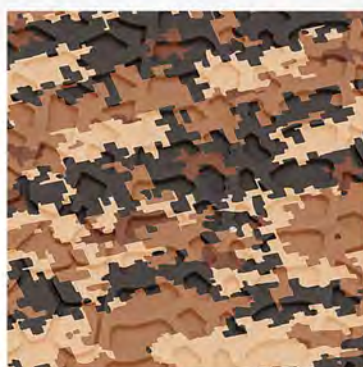

202 - Cyberflage



201 - Rugged Woods "Pink"



203 - Cyberflage "Pink"

FLEXTREAD LLC
1-833-700-3539 EXT. 222
WWW.FLEXTREADMATS.COM





Providing the automotive industry
with the world's highest quality
soft trim products and services
RIGHT HERE AT HOME



THERE REALLY IS A DIFFERENCE!!



Legendary
AUTO INTERIORS LTD.



www.legendaryautointeriors.com





DASHES, CONSOLES AND ACCESORIES

 facebook.com/legendaryautointeriors
 twitter.com/legendaryautoin

 www.legendaryautointeriors.com
 instagram.com/legendaryautointeriorsltd
 youtube.com/user/legendaryauto

PEDAL PADS & BEZELS

Reproduction pedal pads and bezels for accelerators, brake/clutch and parking brake.

ACCELERATORS & BEZELS



1964-67 Skylark & Gran Sport

PB64GA-A (pad) (shown left)\$29.00/ea.

☞ This pad is the closest available to the original.

1968-72 Skylark & Gran Sport

PB68GHK-A (pad) (shown right).....\$ 7.00/ea.

PB68GHK-ABEZ (bezel).....\$10.00/ea.

4-SPEED CLUTCH /BRAKE PADS & BEZELS



1964-72 Skylark & Gran Sport

PB64GA4SP-B/C (pad).....\$5.00/ea.

PB64GA4SP-B/CBEZ (bezel).....\$10.00/pr.

1967-72 Skylark & Gran Sport (w/ Disc Brakes)

PB67GA4SP-B/C (pad).....\$15.00/ea.

☞ Brake only. For clutch pad use part #PB64GA4SP-B/C.

AUTOMATIC BRAKE PADS & BEZELS



1964-72 Skylark & Gran Sport

PB64GA-B (pad).....\$15.00/ea.

PB64GG-BBEZ (bezel).....\$19.00/ea.

1967-72 Skylark & Gran Sport (w/ Disc Brakes)

PB67GA-B (pad).....\$15.00/ea.

PEDAL PADS & BEZELS CONT.

PARKING BRAKE PADS



1964-72 Skylark & Gran Sport

PB64GA-P (pad).....\$ 5.00/ea.

PB64GA-PBEZ (bezel).....\$ 5.00/ea.

GAS PEDAL ROD PIN



Dimensionally accurate to the original with the same fit and function.

1968-72 Skylark & Gran Sport NEW!!!

PB68GA-RODPIN..... \$7.00/ea.

GAS PEDAL SPRING



Correct tension spring for all 68-72 A-Body applications.

1968-72 Skylark & Gran Sport NEW!!!

PB68GA-SPRING \$7.00/ea.

1970-72 WOODGRAIN DASH INSERTS

Make your dash look new again with these authentically reproduced woodgrain vinyl dash inserts for 1970-72 models with or without air conditioning.

1970-72 Skylark & Gran Sport (all models)

WC70GKW/O (w/o A/C)\$39.00/ea.

WC70GKW/A (with A/C)\$39.00/ea.

WOODGRAIN CONSOLE INSERTS

Woodgrain console inserts are machine-stamped and feature an adhesive-backed design.

1970-72 Skylark & Gran Sport

WC70GK.....\$39.00/ea.

GLOVEBOX LINERS

Glovebox liners are die-cut and pre-stapled with all mounting hardware attached for easy installation.



1964-65 Skylark & Gran Sport

GB64GK.....\$29.00/ea.

1966-67 Skylark & Gran Sport

GB66GK.....\$29.00/ea.

1968-69 Skylark & Gran Sport

GB68GKW/O (w/o A/C).....\$29.00/ea.

GB68GKW/A (with A/C).....\$29.00/ea.

1970-72 Skylark & Gran Sport

GB70GKW/O (w/o A/C).....\$39.00/ea.

GB70GKW/A (with A/C).....\$39.00/ea.

DASH PAD EMBLEMS

As-Original dash pad emblems

- 1966 Gran Sport**
DP66GK-EMBLEM \$29.00/ea
- 1966 Skylark (w/ long bird)**
DP66GK-BIRDEMBLEM..... \$39.00/ea
- 1967 GS 400**
DP67GK-EMBLEM \$39.00/ea

FIREWALL INSULATION



Die-cut jute insulation pad comes complete with a stamped rubber backing on one side like the originals. This insulation fastens to and runs the entire length of the firewall to help reduce engine heat and noise. Insulation clips included.

- 1964-67 Skylark & Gran Sport**
FI64GA (without air conditioning).....\$59.00/ea.
FI64GA-W/A (with air conditioning).....\$59.00/ea.
- 1968-72 Skylark & Gran Sport**
FI68GA-W/O (w/o air conditioning)\$59.00/ea.
FI68GA-W/A (with air conditioning).....\$59.00/ea.

OEM FIREWALL INSULATION

Firewalls are cut and punched with standard factory holes and are shipped ready-to-install with the appropriate "period" insulation attached.

- 1964-67 Skylark & Gran Sport** 
FI64GAO (w/o air conditioning)..... \$289.00/ea.
FI64GAO-W/A (with air conditioning) \$289.00/ea.
- 1968-72 Skylark & Gran Sport** 
FI68GAO (w/o air conditioning).....\$289.00/ea.
FI68GAO-W/A (with air conditioning) \$289.00/ea.

FIREWALL GUARD FASTENER

These fasteners will help keep your carpet guard and carpet in their proper positions.



- 1967-69 Camaro**
FI-FASTENER (set of 4)..... \$15.00/set

UNDERDASH INSULATION

Die-cut to original specifications, this insulation eliminates underdash noise and vibration.

- 1964-67 Skylark & Gran Sport**
UD64GA \$15.00/kit
- 1968-72 Skylark & Gran Sport**
UD68GA \$39.00/kit

STEERING COLUMN SEAL

Precision die-cut gasket seals the steering column at the firewall.



- 1964-67 Skylark & Gran Sport**
GK64GA (shown right)..... \$15.00/ea.
- 1968-72 Skylark & Gran Sport**
GK68GA (shown left)..... \$15.00/ea.

FIREWALL STEERING COLUMN COVER

Made of ABS plastic, this cover mounts where the steering column meets the firewall holding the carpet in place around the base of the steering column. Mounting hardware included.



- 1964-66 Skylark & Gran Sport**
TA64GA-COVER (shown bottom).....\$59.00/ea.



- 1967 Skylark & Gran Sporto**
TA67GA-COVER (shown bottom).....\$59.00/ea.



- 1968-72 Skylark & Gran Sport**
TA68GA-COVER (shown top).....\$49.00/ea.

SHIFTER BOOTS



This reproduction shifter boot fits 1965-67 models with standard transmission and no console.

- 1965-67 Skylark & Gran Sport**
TN65GK-L (shown left)\$19.00/ea.





Reproduction shifter boots for 1965-72 models with a console and standard transmission. This boot fits on top of the console.



- 1965-72 Gran Sport**
1968-72 Skylark
TN65GK-U (shown right).....\$59.00/ea.





HEADLINERS AND TRIM ACCESORIES

 facebook.com/legendaryautointeriors
 twitter.com/legendaryautoin

 www.legendaryautointeriors.com
 instagram.com/legendaryautointeriorsltd
 youtube.com/user/legendaryauto

Headliner Grains and Colors

Legendary Auto Interiors headliners are manufactured to original specifications and are available in a variety of colors in Perforated or Non-Perforated pattern. Each headliner is assembled with heavy-duty stitching.

If your year/model is not listed please contact our sales department for assistance on availability. Please specify perforated or non-perforated at time of order. Sample approval is highly recommended for colors other than black.

STANDARD *style*

Ribbed Bedford (1964 & 1968-69)

01 Black	02 White	03 Red	07 Dark Blue	11 Medium Blue	13 Dark Green	17 Buckskin
18 Light Blue	31 Maroon	38 Sandalwood	46 Ivy Gold	58 Powder Blue	98 Brown	

Tier (1965-67)

01 Black	02 White	03 Red	07 Dark Blue	10 Bright Blue	11 Medium Blue	13 Dark Green	17 Buckskin
	20 Bright Red	31 Maroon	50 Turquoise	58 Powder Blue	79 Grey	98 Brown	

Non-Perforated (1970-72)

01 Black	02 White	03 Red	07 Dark Blue	11 Medium Blue	13 Dark Green	38 Sandalwood	98 Brown
--------------------	--------------------	------------------	------------------------	--------------------------	-------------------------	-------------------------	--------------------

HEADLINERS

1964 Skylark (Sport Coupe)

(Ariel Grain)

HL64GK02A (white)	\$169.00/ea.
HL64GK58A (powder blue)	\$169.00/ea.

1965 Skylark & Gran Sport

(Coupe & Sport Coupe)
(Tier Grain)

HL65GK02T (white)	\$169.00/ea.
HL65GK58T (powder blue)	\$169.00/ea.
HL65GK79T (grey)	\$169.00/ea.

1966 Skylark & Gran Sport (Early production)

(Coupe & Sport Coupe)
(Tier Grain)

HL66GK01T1 (black)	\$169.00/ea.
HL66GK02T1 (white)	\$169.00/ea.
HL66GK03T1 (red)	\$169.00/ea.
HL66GK07T1 (dark blue)	\$169.00/ea.
HL66GK10T1 (bright Blue)	\$169.00/ea.
HL66GK11T1 (medium Blue)	\$169.00/ea.
HL66GK13T1 (dark Green)	\$169.00/ea.
HL66GK17T1 (buckskin)	\$169.00/ea.
HL66GK18T1 (light Blue)	\$169.00/ea.
HL66GK20T1 (bright Red)	\$169.00/ea.
HL66GK31T1 (maroon)	\$169.00/ea.
HL66GK50T1 (turquoise)	\$169.00/ea.
HL66GK58T1 (powder Blue)	\$169.00/ea.
HL66GK79T1 (grey)	\$169.00/ea.
HL66GK98T1 (brown)	\$169.00/ea.

☞ On early 1966 models the rear of the headliner continues to the package tray area and has a small sail panel. See diagram shown below.

1966 Skylark & Gran Sport (Late production)

(Coupe & Sport Coupe)
(Tier Grain)

HL66GK01T2 (black)	\$169.00/ea.
HL66GK02T2 (white)	\$169.00/ea.
HL66GK03T2 (red)	\$169.00/ea.
HL66GK07T2 (dark blue)	\$169.00/ea.
HL66GK10T2 (bright Blue)	\$169.00/ea.
HL66GK11T2 (medium Blue)	\$169.00/ea.
HL66GK13T2 (dark Green)	\$169.00/ea.
HL66GK17T2 (buckskin)	\$169.00/ea.
HL66GK18T2 (light Blue)	\$169.00/ea.
HL66GK20T2 (bright Red)	\$169.00/ea.
HL66GK31T2 (maroon)	\$169.00/ea.
HL66GK50T2 (turquoise)	\$169.00/ea.
HL66GK58T2 (powder Blue)	\$169.00/ea.
HL66GK79T2 (grey)	\$169.00/ea.
HL66GK98T2 (brown)	\$169.00/ea.

☞ Late 1966 models have a full sail panel board. See diagram shown below.

1967 Skylark & Gran Sport

(Coupe & Sport Coupe)
(Tier Grain)

HL67GK01T (black)	\$169.00/ea.
HL67GK02T (white)	\$169.00/ea.
HL67GK03T (red)	\$169.00/ea.
HL67GK07T (dark blue)	\$169.00/ea.
HL67GK11T (medium blue)	\$169.00/ea.
HL67GK13T (dark green)	\$169.00/ea.
HL67GK17T (buckskin)	\$169.00/ea.
HL67GK18T (light blue)	\$169.00/ea.
HL67GK20T (bright red)	\$169.00/ea.
HL67GK31T (maroon)	\$169.00/ea.
HL67GK50T (turquoise)	\$169.00/ea.
HL67GK58T (powder blue)	\$169.00/ea.
HL67GK79T (grey)	\$169.00/ea.
HL67GK98T (brown)	\$169.00/ea.

1968 Skylark & Gran Sport (Sport Coupe)

(Ribbed Bedford Grain)

HL68GK501R (black) (5-bow)	\$169.00/ea.
HL68GK502R (white) (5-bow)	\$169.00/ea.
HL68GK507R (dark blue) (5-bow)	\$169.00/ea.
HL68GK511R (med blue) (5-bow)	\$169.00/ea.
HL68GK517R (buckskin) (5-bow)	\$169.00/ea.
HL68GK518R (light blue) (5-bow)	\$169.00/ea.
HL68GK531R (maroon) (5-bow)	\$169.00/ea.
HL68GK538R (sandalwood) (5-bow)	\$169.00/ea.
HL68GK601R (black) (6-bow)	\$169.00/ea.
HL68GK602R (white) (6-bow)	\$169.00/ea.
HL68GK607R (dark blue) (6-bow)	\$169.00/ea.
HL68GK611R (med blue) (6-bow)	\$169.00/ea.
HL68GK617R (buckskin) (6-bow)	\$169.00/ea.
HL68GK618R (light blue) (6-bow)	\$169.00/ea.
HL68GK631R (maroon) (6-bow)	\$169.00/ea.
HL68GK638R (sandalwood) (6-bow)	\$169.00/ea.

1969 Skylark & Gran Sport (Sport Coupe)

(Ribbed Bedford Grain)

HL69GK01R (black)	\$169.00/ea.
HL69GK02R (white)	\$169.00/ea.
HL69GK03R (red)	\$169.00/ea.
HL69GK07R (dark blue)	\$169.00/ea.
HL69GK11R (medium blue)	\$169.00/ea.
HL69GK13R (dark green)	\$169.00/ea.
HL69GK17R (buckskin)	\$169.00/ea.
HL69GK18R (light blue)	\$169.00/ea.
HL69GK31R (maroon)	\$169.00/ea.
HL69GK38R (sandalwood)	\$169.00/ea.

1970-72 Skylark & Gran Sport (Coupe)

(Non-Perforated Grain)

HL70GK01NP1 (black)	\$169.00/ea.
HL70GK02NP1 (white)	\$169.00/ea.
HL70GK03NP1 (red)	\$169.00/ea.
HL70GK07NP1 (dark blue)	\$169.00/ea.
HL70GK11NP1 (medium blue)	\$169.00/ea.
HL70GK13NP1 (dark green)	\$169.00/ea.
HL70GK17NP1 (buckskin)	\$169.00/ea.
HL70GK18NP1 (light blue)	\$169.00/ea.
HL70GK31NP1 (maroon)	\$169.00/ea.
HL70GK38NP1 (sandalwood)	\$169.00/ea.
HL70GK98NP1 (brown)	\$169.00/ea.

1970-72 Skylark & Gran Sport (Sport Coupe)

(Non-Perforated Grain)

HL70GK01NP2 (black)	\$169.00/ea.
HL70GK02NP2 (white)	\$169.00/ea.
HL70GK03NP2 (red)	\$169.00/ea.
HL70GK07NP2 (dark blue)	\$169.00/ea.
HL70GK11NP2 (medium blue)	\$169.00/ea.
HL70GK13NP2 (dark green)	\$169.00/ea.
HL70GK17NP2 (buckskin)	\$169.00/ea.
HL70GK18NP2 (light blue)	\$169.00/ea.
HL70GK31NP2 (maroon)	\$169.00/ea.
HL70GK38NP2 (sandalwood)	\$169.00/ea.
HL70GK98NP2 (brown)	\$169.00/ea.

NOS HEADLINERS

Some colors and grains are not reproduced in today's market. We offer NOS (New Old Stock) headliners for those extremely limited items. Many years and models are available. Please call for assistance.

HLNOS.....\$935.00/ea.

☞ Please specify year and model.

HEADLINER INSULATION

Headliner insulation kits glue directly to the roof and provide protection from noise, heat and cold infiltration.



1964-67 Skylark & Gran Sport

HL64GA (4pc.).....\$29.00/ea.

1968-72 Skylark & Gran Sport

HL68GA (4pc.).....\$29.00/ea.

HEADLINER BOW RETAINER CLIPS

Plastic retainer clips slide onto the edge of the inner roof-rail and help secure the headliner bows during installation of headliner.



1964-72 Skylark & Gran Sport

HLGA-CLIPS4 (Pkg/4).....\$19.00/pk.

1968-72 Skylark & Gran Sport

HLGA-CLIPS6 (Pkg/6).....\$29.00/pk.

UPPER WINDSHIELD TRIM

Interior upper windshield trim strip mounts at the top of the windshield and helps hold the headliner in place. Available in black only, paint as required.

1964-67 Skylark & Gran Sport

WT64GA.....\$27.00/ea.

REAR WINDOW TRIM

Interior rear window trim made of molded plastic features all the correct contours as the originals. This trim snaps into place around the rear window holding the headliner and sail panel boards in place along with providing a finished look. Available in black only, paint as required.

1965 Skylark & Gran Sport (Hardtop)

RT65GK03 (Complete 3 pc. set).....\$99.00/set

SAIL PANEL BOARDS

Die-cut to original size and shape, these reproduction sail panel boards replace warped or water damaged originals. These panels are located between the package tray and headliner and come pre-covered with headliner material. Please specify pattern along with color at time of order.
NOTE: Due to a special proprietary process used in-house, we guarantee the vinyl WILL NOT bubble or delaminate from the board.



1964 Skylark & Gran Sport
(Ariel Grain)

- SB64GK02A (white)..... \$97.00/pr.
- SB64GK58A (powder blue)..... \$97.00/pr.

1965 Skylark & Gran Sport
(Tier Grain)

- SB64GK02R (white)..... \$66.00/pr.
- SB64GK58R (powder blue)..... \$66.00/pr.

1967 Skylark & Gran Sport
(Tier Grain)

- SB66GK01T2 (black)..... \$66.00/pr.
- SB66GK02T2 (white)..... \$66.00/pr.
- SB66GK03T2 (red)..... \$66.00/pr.
- SB66GK07T2 (dark blue)..... \$66.00/pr.
- SB66GK10T2 (bright blue)..... \$66.00/pr.
- SB66GK11T2 (medium blue)..... \$66.00/pr.
- SB66GK13T2 (dark green)..... \$66.00/pr.
- SB66GK17T2 (buckskin)..... \$66.00/pr.
- SB66GK18T2 (light blue)..... \$66.00/pr.
- SB66GK20T2 (bright red)..... \$66.00/pr.
- SB66GK25T2 (dark brown)..... \$66.00/pr.
- SB66GK31T2 (maroon)..... \$66.00/pr.
- SB66GK38T2 (sandalwood)..... \$66.00/pr.
- SB66GK50T2 (turquoise)..... \$66.00/pr.
- SB66GK58T2 (powder blue)..... \$66.00/pr.
- SB66GK79T2 (grey)..... \$66.00/pr.
- SB66GK98T2 (brown)..... \$66.00/pr.

1968-69 Skylark & Gran Sport
(Ribbed Bedford Grain)

- SB68GK01R (black)..... \$66.00/pr.
- SB68GK02R (white)..... \$66.00/pr.
- SB68GK03R (red)..... \$66.00/pr.
- SB68GK07R (dark blue)..... \$66.00/pr.
- SB68GK11R (medium blue)..... \$66.00/pr.
- SB68GK13R (dark green)..... \$66.00/pr.
- SB68GK17R (buckskin)..... \$66.00/pr.
- SB68GK18R (light blue)..... \$66.00/pr.
- SB68GK31R (maroon)..... \$66.00/pr.
- SB68GK38R (sandalwood)..... \$66.00/pr.

1970-72 Skylark & Gran Sport
(Non-Perforated Grain)

- SB70GK01NP (black)..... \$66.00/pr.
- SB70GK02NP (white)..... \$66.00/pr.
- SB70GK03NP (red)..... \$66.00/pr.
- SB70GK07NP (dark blue)..... \$66.00/pr.
- SB70GK11NP (medium blue)..... \$66.00/pr.
- SB70GK13NP (dark green)..... \$66.00/pr.
- SB70GK17NP (buckskin)..... \$66.00/pr.
- SB70GK18NP (light blue)..... \$66.00/pr.
- SB70GK31NP (maroon)..... \$66.00/pr.
- SB70GK38NP (sandalwood)..... \$66.00/pr.
- SB70GK98NP (brown)..... \$66.00/pr.

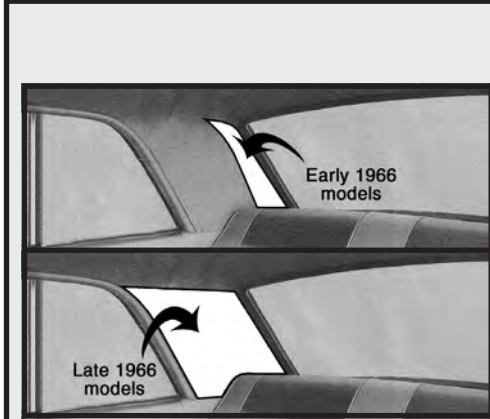

1966 Skylark & Gran Sport (Early production)
(Tier Grain)

- SB66GK01T1 (black)..... \$55.00/pr.
- SB66GK02T1 (white)..... \$55.00/pr.
- SB66GK03T1 (red)..... \$55.00/pr.
- SB66GK07T1 (dark blue)..... \$55.00/pr.
- SB66GK10T1 (bright blue)..... \$55.00/pr.
- SB66GK11T1 (medium blue)..... \$55.00/pr.
- SB66GK13T1 (dark green)..... \$55.00/pr.
- SB66GK17T1 (buckskin)..... \$55.00/pr.
- SB66GK18T1 (light blue)..... \$55.00/pr.
- SB66GK20T1 (bright red)..... \$55.00/pr.
- SB66GK25T1 (dark brown)..... \$55.00/pr.
- SB66GK31T1 (maroon)..... \$55.00/pr.
- SB66GK38T1 (sandalwood)..... \$55.00/pr.
- SB66GK50T1 (turquoise)..... \$55.00/pr.
- SB66GK58T1 (powder blue)..... \$55.00/pr.
- SB66GK79T1 (grey)..... \$55.00/pr.
- SB66GK98T1 (brown)..... \$55.00/pr.

1966 Skylark & Gran Sport (Late production)
(Tier Grain)

- SB66GK01T2 (black)..... \$66.00/pr.
- SB66GK02T2 (white)..... \$66.00/pr.
- SB66GK03T2 (red)..... \$66.00/pr.
- SB66GK07T2 (dark blue)..... \$66.00/pr.
- SB66GK10T2 (bright blue)..... \$66.00/pr.
- SB66GK11T2 (medium blue)..... \$66.00/pr.
- SB66GK13T2 (dark green)..... \$66.00/pr.
- SB66GK17T2 (buckskin)..... \$66.00/pr.
- SB66GK18T2 (light blue)..... \$66.00/pr.
- SB66GK20T2 (bright red)..... \$66.00/pr.
- SB66GK25T2 (dark brown)..... \$66.00/pr.
- SB66GK31T2 (maroon)..... \$66.00/pr.
- SB66GK38T2 (sandalwood)..... \$66.00/pr.
- SB66GK50T2 (turquoise)..... \$66.00/pr.
- SB66GK58T2 (powder blue)..... \$66.00/pr.
- SB66GK79T2 (grey)..... \$66.00/pr.
- SB66GK98T (brown)..... \$66.00/pr.

☞ Early 1966 models have a small sail panel.

☞ Late 1966 models have a full sail panel board.

DOME LIGHT LENS & BEZELS

Replacement dome light lenses and bezels for 1964-72 models.



1964-67 Skylark & Gran Sport

- LL64GA (Lens only)..... \$10.00/ea.
- LL64GA-BEZ (Bezel only)..... \$29.00/ea.



1968 Skylark & Gran Sport

- LL68GA (Lens only)..... \$15.00/ea.
- LL68GA-BEZ (Bezel only)..... \$29.00/ea.



1969-72 Skylark & Gran Sport

- LL69GA (Lens only)..... \$10.00/ea.
- LL69GA-BEZ (Bezel only)..... \$15.00/ea.

SAIL PANEL WITH COURTESY LIGHT

1964 Skylark & Gran Sport

- SB64GK(C)T-CRTSY..... \$57.00/ea.

1965 Skylark & Gran Sport

- SB65GK(C)T-CRTSY..... \$57.00/ea.

COURTESY LIGHT LENSES & BEZELS

These replacement lenses and bezels mount to the interior sail panel boards located between the headliner and package tray.



1964-67 Skylark & Gran Sport

- LL64GA-CRTSY (Lens) (shown)..... \$10.00/ea.
- LL64GA-CRTSYBEZ (Bezel) (shown)..... \$49.00/ea.

PILLAR POST MOLDINGS

These urethane-molded, not foam filled pillar moldings feature authentic grain and texture as the originals. Available in Black only, but can be painted to match interior colors.



1968-69 Skylark & Gran Sport

- PP68GA-CPE01 (Black) (Coupe)..... \$129.00/pr.

1968-72 Skylark & Gran Sport

- PP68GA-CONV01 (Black) (Conv.)..... \$129.00/pr.



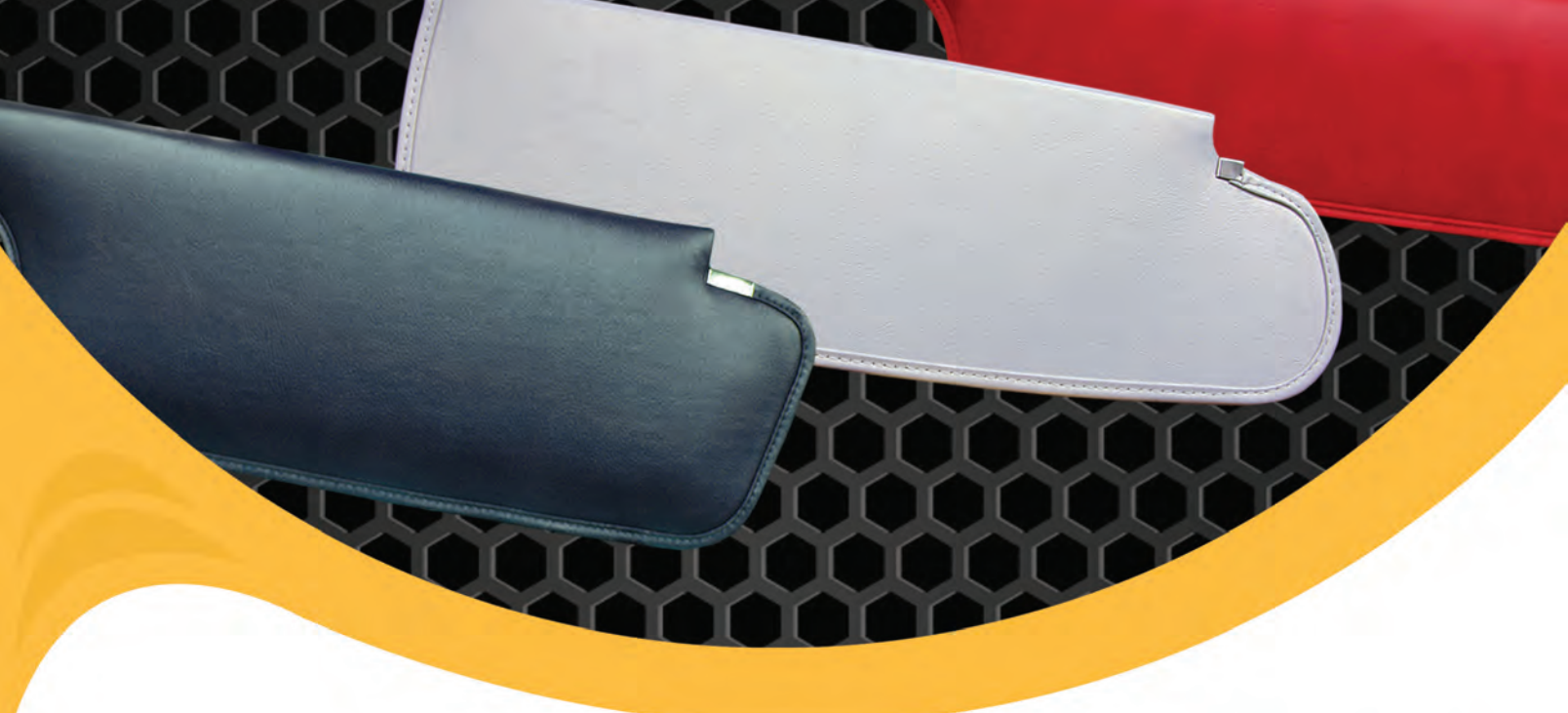

SUNVISORS

Original reproduction sunvisors are made with the correct grains and vinyl colors as applicable by year/make/model to compliment and match your Legendary interior. Superior materials and technology with World Class craftsmanship create the highest quality sunvisors available. Original mounting hardware and metal rod must be reused. Please specify hardtop or convertible and color at time of order.

- Factory correct size, shape, colors and grains by year, make and model
- Original fit and appearance
- Custom colors and grains available
- Limited Lifetime Warranty (*First and only in the industry!!!*)
- Correct multi layer construction applicable by year, make and model
- Available with or without cut-outs for driver and passenger mirror options



Correct multi layer construction & shape applicable by year, make, model & body style

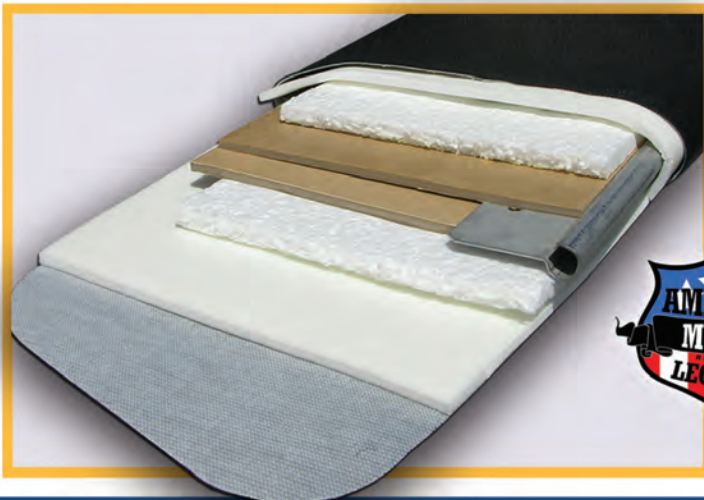

HARDTOP & SPORTS COUPE SUNVISORS

1964 Skylark & Gran Sport (Sport Coupe) (Ariel Grain)

SV64GK02A-PA (white)\$233.00/pr.
SV64GK58A-PA (powder blue).....\$233.00/pr.

1965 Skylark & Gran Sport (Sport Coupe) (Tier Grain)

SV65GK01T-PA (black).....\$168.00/pr.
SV65GK02T-PA (white).....\$168.00/pr.
SV65GK58T-PA (powder blue).....\$168.00/pr.

1966-67 Skylark & Gran Sport (Sport Coupe) (Tier Grain)

SV66GK01T-PA (black).....\$168.00/pr.
SV66GK02T-PA (white).....\$168.00/pr.
SV66GK07T-PA (dark blue).....\$168.00/pr.
SV66GK11T-PA (medium blue).....\$168.00/pr.
SV66GK50T-PA (turquoise).....\$168.00/pr.

1968 Skylark & Gran Sport (Sport Coupe) (Ribbed Bedford Grain)

SV68GK01R-PA (black).....\$168.00/pr.
SV68GK02R-PA (white).....\$168.00/pr.
SV68GK03R-PA (red).....\$168.00/pr.
SV68GK11R-PA (medium blue).....\$168.00/pr.
SV68GK13R-PA (dark green).....\$168.00/pr.
SV68GK17R-PA (buckskin).....\$168.00/pr.
SV68GK31R-PA (maroon).....\$168.00/pr.
SV68GK38R-PA (sandalwood).....\$168.00/pr.

1969 Skylark & Gran Sport (Sport Coupe) (Ribbed Bedford Grain)

SV69GK01R-PA (black).....\$168.00/pr.
SV69GK02R-PA (white).....\$168.00/pr.
SV69GK03R-PA (red).....\$168.00/pr.
SV69GK11R-PA (medium blue).....\$168.00/pr.
SV69GK13R-PA (dark green).....\$168.00/pr.
SV69GK17R-PA (buckskin).....\$168.00/pr.
SV69GK31R-PA (maroon).....\$168.00/pr.
SV69GK38R-PA (sandalwood).....\$168.00/pr.

1970 Skylark & Gran Sport (Coupe & Sport Coupe) (Non-Perforated Grain)

SV70GK01NP-PA (black).....\$168.00/pr.
SV70GK02NP-PA (white).....\$168.00/pr.
SV70GK03NP-PA (red).....\$168.00/pr.
SV70GK11NP-PA (medium blue).....\$168.00/pr.
SV70GK13NP-PA (dark green).....\$168.00/pr.
SV70GK17NP-PA (buckskin).....\$168.00/pr.
SV70GK31NP-PA (maroon).....\$168.00/pr.
SV70GK38NP-PA (sandalwood).....\$168.00/pr.

1971-72 Skylark & Gran Sport (Coupe & Sport Coupe) (Non-Perforated Grain)

SV71GK01NP-PA (black).....\$168.00/pr.
SV71GK02NP-PA (white).....\$168.00/pr.
SV71GK13NP-PA (dark green).....\$168.00/pr.
SV71GK17NP-PA (buckskin).....\$168.00/pr.
SV71GK38NP-PA (sandalwood).....\$168.00/pr.
SV71GK98NP-PA (brown).....\$168.00/pr.

CONVERTIBLE SUNVISORS

1964 Skylark - (Seville Grain)

SV64GA100G-PA (black).....\$168.00/pr.
SV64GA206G-PA (white).....\$168.00/pr.
SV64GA220G-PA (frost white).....\$168.00/pr.
SV64GA231G-PA (fawn).....\$279.00/pr.
SV64GA325G-PA (metallic blue).....\$168.00/pr.
SV64GA334G-PA (dark met blue).....\$168.00/pr.
SV64GA343G-PA (dark met blue).....\$168.00/pr.
SV64GA418G-PA (aqua).....\$168.00/pr.
SV64GA419G-PA (aqua).....\$279.00/pr.
SV64GA508G-PA (red).....\$168.00/pr.
SV64GA625G-PA (saddle).....\$168.00/pr.
SV64GA656G-PA (brown).....\$168.00/pr.

1965 Skylark & Gran Sport - (Madrid Grain)

SV65GA100G-PA (black).....\$168.00/pr.
SV65GA140G-PA (slate).....\$168.00/pr.
SV65GA206G-PA (white).....\$168.00/pr.
SV65GA220G-PA (frost white).....\$168.00/pr.
SV65GA232G-PA (fawn).....\$279.00/pr.
SV65GA235G-PA (fawn).....\$168.00/pr.
SV65GA239G-PA (met parchment).....\$168.00/pr.
SV65GA314G-PA (sterling blue).....\$279.00/pr.
SV65GA325G-PA (light met blue).....\$168.00/pr.
SV65GA343G-PA (dark met blue).....\$168.00/pr.
SV65GA420G-PA (met turquoise).....\$168.00/pr.
SV65GA448G-PA (dk met turquoise).....\$168.00/pr.
SV65GA501G-PA (red).....\$168.00/pr.
SV65GA506G-PA (dark met red).....\$168.00/pr.
SV65GA520G-PA (metallic red).....\$168.00/pr.
SV65GA528G-PA (red).....\$168.00/pr.
SV65GA642G-PA (gold).....\$168.00/pr.
SV65GA677G-PA (met brown).....\$279.00/pr.
SV65GA679G-PA (saddle).....\$279.00/pr. (L1)
SV65GA710G-PA (buckskin).....\$168.00/pr.

1966-67 Skylark & Gran Sport - (Madrid Grain)

SV66GA100G-PA (black).....\$168.00/pr.
SV66GA220G-PA (frost white).....\$168.00/pr.
SV66GA235G-PA (fawn).....\$168.00/pr.
SV66GA239G-PA (met parchment).....\$168.00/pr.
SV66GA240G-PA (parchment).....\$168.00/pr.
SV66GA310G-PA (metallic blue).....\$168.00/pr.
SV66GA325G-PA (light met blue).....\$168.00/pr.
SV66GA338G-PA (bright blue).....\$168.00/pr.
SV66GA343G-PA (dark met blue).....\$168.00/pr.
SV66GA420G-PA (metallic aqua).....\$168.00/pr.
SV66GA421G-PA (dark met aqua).....\$168.00/pr.
SV66GA424G-PA (met turquoise).....\$168.00/pr.
SV66GA425G-PA (turquoise).....\$168.00/pr.
SV66GA448G-PA (dk met turquoise).....\$168.00/pr.
SV66GA501G-PA (red).....\$168.00/pr.
SV66GA515G-PA (burgundy).....\$168.00/pr.
SV66GA520G-PA (metallic red).....\$168.00/pr.
SV66GA521G-PA (metallic red).....\$168.00/pr.
SV66GA526G-PA (bronze).....\$279.00/pr.
SV66GA631G-PA (metallic bronze).....\$168.00/pr.
SV66GA640G-PA (pearl yellow).....\$168.00/pr.
SV66GA651G-PA (metallic gold).....\$168.00/pr.
SV66GA680G-PA (saddle).....\$168.00/pr.

1964-72 HARDTOP SUNVISOR SUPPORTS

Chrome sunvisor support with correct tension screw to insure an accurate fit for original and reproduction sunvisors.



1964-72 Skylark & Gran Sport

SV64GA-SUPPORT.....\$29.00/ea.

SUNVISOR TIP & BUSHING KIT



Sunvisor tips with sleeves for 1964-72 models with double pin sunvisors and a center mounted sunvisor retainer over the rearview mirror. Set includes 2 rubber tips and 2 plastic sleeves.

SVTIP-KIT.....\$10.00/kit

1968 Skylark & Gran Sport - (Madrid Grain)

SV68GA100G-PA (black).....\$168.00/pr.
SV68GA135G-PA (platinum).....\$168.00/pr.
SV68GA204G-PA (met parchment).....\$168.00/pr.
SV68GA220G-PA (frost white).....\$168.00/pr.
SV68GA331G-PA (metallic blue).....\$168.00/pr.
SV68GA332G-PA (light met blue).....\$168.00/pr.
SV68GA333G-PA (teal blue).....\$168.00/pr.
SV68GA429G-PA (turquoise).....\$168.00/pr.
SV68GA501G-PA (red).....\$168.00/pr.
SV68GA502G-PA (red).....\$168.00/pr.
SV68GA645G-PA (willow gold).....\$168.00/pr.
SV68GA709G-PA (buckskin).....\$168.00/pr.

1969 Skylark & Gran Sport - (Madrid Grain)

SV69GA100G-PA (black).....\$168.00/pr.
SV69GA235G-PA (parchment).....\$168.00/pr.
SV69GA239G-PA (met parchment).....\$168.00/pr.
SV69GA325G-PA (light met blue).....\$168.00/pr.
SV69GA369G-PA (dark met blue).....\$168.00/pr.
SV69GA469G-PA (metallic green).....\$168.00/pr.
SV69GA503G-PA (red).....\$168.00/pr.
SV69GA511G-PA (red).....\$168.00/pr.
SV69GA513G-PA (red).....\$168.00/pr.
SV69GA635G-PA (gold).....\$168.00/pr.
SV69GA710G-PA (buckskin).....\$168.00/pr.

1970-72 Skylark & Gran Sport - (Madrid Grain)

SV70GA100G-PA (black).....\$168.00/pr.
SV70GA138G-PA (pewter).....\$168.00/pr.
SV70GA202G-PA (pearl white).....\$168.00/pr.
SV70GA230G-PA (white).....\$168.00/pr.
SV70GA310G-PA (lt met blue).....\$168.00/pr.
SV70GA342G-PA (metallic blue).....\$168.00/pr.
SV70GA380G-PA (blue).....\$168.00/pr.
SV70GA415G-PA (jade green).....\$168.00/pr.
SV70GA460G-PA (metallic green).....\$168.00/pr.
SV70GA465G-PA (72' green).....\$168.00/pr.
SV70GA468G-PA (71' green).....\$168.00/pr.
SV70GA513G-PA (red).....\$168.00/pr.
SV70GA650G-PA (gold).....\$168.00/pr.
SV70GA657G-PA (sienna).....\$168.00/pr.
SV70GA658G-PA (burnt saddle).....\$168.00/pr.
SV70GA670G-PA (saddle).....\$168.00/pr.
SV70GA683G-PA (saddle).....\$168.00/pr.
SV70GA690G-PA (saddle).....\$168.00/pr.
SV70GA694G-PA (sandalwood).....\$168.00/pr.
SV70GA697G-PA (sandalwood).....\$168.00/pr.

CONVERTIBLE SUNVISOR BRACKETS



Diecast, high-strength, chromed to perfection. Guaranteed in fit and function to be identical to the original GM part.

1964-65 Skylark & Gran Sport

SV64GA-BRACKET.....\$139.00/pr.

1966-67 Skylark & Gran Sport

SV66GA-BRACKET.....\$99.00/pr.





1968-72 Skylark & Gran Sport



SV68GA-BRACKET.....\$99.00/pr.





PACKAGE TRAY AND TRUNK ACCESORIES

 facebook.com/legendaryautointeriors
 twitter.com/legendaryautoin

 www.legendaryautointeriors.com
 instagram.com/legendaryautointeriorsltd
 youtube.com/user/legendaryauto

PACKAGE TRAYS AND JUTE INSULATION

Die-cut to original specifications, these reproductions of the original panels go between the top of the rear seat and the back window. Colors are year specific and are available with or without speaker grill cutouts. Die-cut jute insulation helps reduce the amount of noise and heat that would come from the trunk compartment.

1964-65 Skylark & Gran Sport (Coupe)

(Without Cuts)

PT64GKS100GN (black)	\$79.00/ea.
PT64GKS325GN (light metallic blue)	\$79.00/ea.
PT64GKS520GN (metallic red)	\$79.00/ea.
PT64GKS679GN (saddle)	\$79.00/ea.

(With Cuts)

PT64GKS100G (black)	\$119.00/ea.
PT64GKS325G (light metallic blue)	\$119.00/ea.
PT64GKS520G (metallic red)	\$119.00/ea.
PT64GKS679G (saddle)	\$119.00/ea.
PT64GKSJ (jute insulation)	\$25.00/ea.

 Will fit both 2 & 4-door models.

1964 Skylark & Gran Sport (Sport Coupe)

(Without Cuts)

PT64GK100GN (black)	\$79.00/ea.
PT64GK334GN (dark metallic blue)	\$79.00/ea.
PT64GK405GN (metallic green)	\$79.00/ea.
PT64GK508GN (red)	\$79.00/ea.
PT64GK656GN (brown)	\$79.00/ea.

(With Cuts)

PT64GK100G (black)	\$119.00/ea.
PT64GK334G (dark metallic blue)	\$119.00/ea.
PT64GK405G (metallic green)	\$119.00/ea.
PT64GK508G (red)	\$119.00/ea.
PT64GK656G (brown)	\$119.00/ea.
PT64GKJ (jute insulation)	\$25.00/ea.

1965 Skylark & Gran Sport (Sport Coupe)

(Without Cuts)

PT64GK100GN (black)	\$79.00/ea.
PT64GK343GN (dark metallic blue)	\$79.00/ea.
PT64GK520GN (metallic red)	\$79.00/ea.
PT64GK679GN (saddle)	\$79.00/ea.

(With Cuts)

PT64GK100G (black)	\$119.00/ea.
PT64GK343G (dark metallic blue)	\$119.00/ea.
PT64GK520G (metallic red)	\$119.00/ea.
PT64GK679G (saddle)	\$119.00/ea.
PT64GKJ (jute insulation)	\$25.00/ea.

1966 Skylark & Gran Sport (Sport Coupe)

(Without Cuts)

PT66GK100GN (black)	\$79.00/ea.
PT66GK325GN (light metallic blue)	\$79.00/ea.
PT66GK420GN (light aqua)	\$79.00/ea.
PT66GK520GN (metallic red)	\$79.00/ea.

(With Cuts)

PT66GK100G (black)	\$119.00/ea.
PT66GK325G (light metallic blue)	\$119.00/ea.
PT66GK420G (light aqua)	\$119.00/ea.
PT66GK520G (metallic red)	\$119.00/ea.
PT66GKJ (jute insulation)	\$25.00/ea.

1967 Skylark & Gran Sport (Sport Coupe)

(Without Cuts)

PT66GK100GN (black)	\$79.00/ea.
PT66GK325GN (light metallic blue)	\$79.00/ea.
PT66GK343GN (dark metallic blue)	\$79.00/ea.
PT66GK448GN (turquoise)	\$79.00/ea.
PT66GK501GN (red)	\$79.00/ea.
PT66GK650GN (gold)	\$79.00/ea.
PT66GK680GN (saddle)	\$79.00/ea.

(With Cuts)

PT66GK100G (black)	\$119.00/ea.
PT66GK325G (light metallic blue)	\$119.00/ea.
PT66GK343G (dark metallic blue)	\$119.00/ea.
PT66GK448G (turquoise)	\$119.00/ea.
PT66GK501G (red)	\$119.00/ea.
PT66GK650G (gold)	\$119.00/ea.
PT66GK680G (saddle)	\$119.00/ea.
PT66GKJ (jute insulation)	\$25.00/ea.

PACKAGE TRAYS & JUTE INSULATION

1966-67 Special & Skylark (Sedan) 

(4 Door Without Cuts)

PT66GKS4D01N (black).....\$79.00/ea.
 PT66GKS4D03N (red).....\$79.00/ea.
 PT66GKS4D07N (dark blue).....\$79.00/ea.
 PT66GKS4D13N (dark green).....\$79.00/ea.
 PT66GKS4D18N (buckskin).....\$79.00/ea.
 PT66GKS4D23N (tan).....\$79.00/ea.
 PT66GKS4D25N (dark brown).....\$79.00/ea.
 PT66GKS4D31N (maroon).....\$79.00/ea.
 PT66GKS4D32N (gold).....\$79.00/ea.

(4 Door With Cuts)

PT66GKS4D01 (black).....\$119.00/ea.
 PT66GKS4D03 (red).....\$119.00/ea.
 PT66GKS4D07 (dark blue).....\$119.00/ea.
 PT66GKS4D13 (dark green).....\$119.00/ea.
 PT66GKS4D18 (buckskin).....\$119.00/ea.
 PT66GKS4D23 (tan).....\$119.00/ea.
 PT66GKS4D25 (dark brown).....\$119.00/ea.
 PT66GKS4D31 (maroon).....\$119.00/ea.
 PT66GKS4D32 (gold).....\$119.00/ea.
 PT66GKS4DJ (jute insulation).....\$25.00/ea.

1966-67 Skylark (Hardtop) 

(4 Door Without Cuts)

PT66GK4D01N (black).....\$79.00/ea.
 PT66GK4D03N (red).....\$79.00/ea.
 PT66GK4D07N (dark blue).....\$79.00/ea.
 PT66GK4D13N (dark green).....\$79.00/ea.
 PT66GK4D18N (light blue).....\$79.00/ea.
 PT66GK4D23N (tan).....\$79.00/ea.
 PT66GK4D25N (dark brown).....\$79.00/ea.
 PT66GK4D31N (maroon).....\$79.00/ea.
 PT66GK4D32N (gold).....\$79.00/ea.

(4 Door With Cuts)

PT66GK4D01 (black).....\$119.00/ea.
 PT66GK4D03 (red).....\$119.00/ea.
 PT66GK4D07 (dark blue).....\$119.00/ea.
 PT66GK4D13 (dark green).....\$119.00/ea.
 PT66GK4D18 (light blue).....\$119.00/ea.
 PT66GK4D23 (tan).....\$119.00/ea.
 PT66GK4D25 (dark brown).....\$119.00/ea.
 PT66GK4D31 (maroon).....\$119.00/ea.
 PT66GK4D32 (gold).....\$119.00/ea.
 PT66GK4DJ (jute insulation).....\$25.00/ea.

1968-72 Skylark (Sport Coupe) 

(Without Cuts)

PT68GK100GN (black).....\$79.00/ea.
 PT68GK135GN (platinum).....\$79.00/ea.
 PT68GK333GN (teal blue).....\$79.00/ea.
 PT68GK709GN (buckskin).....\$79.00/ea.

(With Cuts)

PT68GK100G (black).....\$119.00/ea.
 PT68GK135G (platinum).....\$119.00/ea.
 PT68GK333G (teal blue).....\$119.00/ea.
 PT68GK709G (buckskin).....\$119.00/ea.
 PT68GKJ (jute insulation).....\$25.00/ea.

1969 Skylark (Sport Coupe)

(Without Cuts)

PT68GK100GN (black).....\$79.00/ea.
 PT68GK325GN (metallic blue).....\$79.00/ea.
 PT68GK450GN (metallic green).....\$79.00/ea.
 PT68GK710GN (buckskin).....\$79.00/ea.

(With Cuts)

PT68GK100G (black).....\$119.00/ea.
 PT68GK325G (metallic blue).....\$119.00/ea.
 PT68GK450G (metallic green).....\$119.00/ea.
 PT68GK710G (buckskin).....\$119.00/ea.
 PT68GKJ (jute insulation).....\$25.00/ea.

1970 Skylark (Sport Coupe) 

(Without Cuts)

PT68GK100GN (black).....\$79.00/ea.
 PT68GK310GN (metallic blue).....\$79.00/ea.
 PT68GK342GN (dark metallic blue).....\$79.00/ea.
 PT68GK460GN (metallic green).....\$79.00/ea.
 PT68GK658GN (burnished saddle).....\$79.00/ea.
 PT68GK683GN (saddle).....\$79.00/ea.
 PT68GK694GN (sandalwood).....\$79.00/ea.

(With Cuts)

PT68GK100G (black).....\$119.00/ea.
 PT68GK310G (metallic blue).....\$119.00/ea.
 PT68GK342G (dark metallic blue).....\$119.00/ea.
 PT68GK460G (metallic green).....\$119.00/ea.
 PT68GK658G (burnished saddle).....\$119.00/ea.
 PT68GK683G (saddle).....\$119.00/ea.
 PT68GK694G (sandalwood).....\$119.00/ea.
 PT68GKJ (jute insulation).....\$25.00/ea.

1971 Skylark (Sport Coupe) 

(Without Cuts)

PT68GK100GN (black).....\$79.00/ea.
 PT68GK465GN (green).....\$79.00/ea.
 PT68GK690GN (saddle).....\$79.00/ea.
 PT68GK697GN (sandalwood).....\$79.00/ea.

(With Cuts)

PT68GK100G (black).....\$119.00/ea.
 PT68GK465G (green).....\$119.00/ea.
 PT68GK690G (saddle).....\$119.00/ea.
 PT68GK697G (sandalwood).....\$119.00/ea.
 PT68GKJ (jute insulation).....\$25.00/ea.

1972 Skylark (Sport Coupe) 

(Without Cuts)

PT68GK100GN (black).....\$79.00/ea.
 PT68GK465GN (green).....\$79.00/ea.
 PT68GK690GN (saddle).....\$79.00/ea.
 PT68GK697GN (sandalwood).....\$79.00/ea.

(With Cuts)

PT68GK100G (black).....\$119.00/ea.
 PT68GK465G (green).....\$119.00/ea.
 PT68GK690G (saddle).....\$119.00/ea.
 PT68GK697G (sandalwood).....\$119.00/ea.
 PT68GKJ (jute insulation).....\$25.00/ea.

1968 Gran Sport (Sport Coupe) 

(Without Cuts)

PT68GKGS100GN (black).....\$79.00/ea.
 PT68GKGS135GN (platinum).....\$79.00/ea.
 PT68GKGS333GN (teal blue).....\$79.00/ea.
 PT68GKGS709GN (buckskin).....\$79.00/ea.

(With Cuts)

PT68GKGS100G (black).....\$119.00/ea.
 PT68GKGS135G (platinum).....\$119.00/ea.
 PT68GKGS333G (teal blue).....\$119.00/ea.
 PT68GKGS709G (buckskin).....\$119.00/ea.
 PT68GKGSJ (jute insulation).....\$25.00/ea.

1969 Gran Sport (Sport Coupe) 

(Without Cuts)

PT68GKGS100GN (black).....\$79.00/ea.
 PT68GKGS325GN (metallic blue).....\$79.00/ea.
 PT68GKGS450GN (metallic green).....\$79.00/ea.
 PT68GKGS710GN (buckskin).....\$79.00/ea.

(With Cuts)

PT68GKGS100G (black).....\$119.00/ea.
 PT68GKGS325G (metallic blue).....\$119.00/ea.
 PT68GKGS450G (metallic green).....\$119.00/ea.
 PT68GKGS710G (buckskin).....\$119.00/ea.
 PT68GKGSJ (jute insulation).....\$25.00/ea.

1970 Gran Sport (Sport Coupe) 

(Without Cuts)

PT68GKGS100GN (black).....\$79.00/ea.
 PT68GKGS310GN (metallic blue).....\$79.00/ea.
 PT68GKGS342GN (dark met blue).....\$79.00/ea.
 PT68GKGS460GN (metallic green).....\$79.00/ea.
 PT68GKGS658GN (burnished saddle).....\$79.00/ea.
 PT68GKGS683GN (saddle).....\$79.00/ea.
 PT68GKGS694GN (sandalwood).....\$79.00/ea.

(With Cuts)

PT68GKGS100G (black).....\$119.00/ea.
 PT68GKGS310G (metallic blue).....\$119.00/ea.
 PT68GKGS342G (dark met blue).....\$119.00/ea.
 PT68GKGS460G (metallic green).....\$119.00/ea.
 PT68GKGS658G (burnished saddle).....\$119.00/ea.
 PT68GKGS683G (saddle).....\$119.00/ea.
 PT68GKGS694G (sandalwood).....\$119.00/ea.
 PT68GKGSJ (jute insulation).....\$25.00/ea.

1971 Gran Sport (Sport Coupe) 

(Without Cuts)

PT68GKGS100GN (black).....\$79.00/ea.
 PT68GKGS468GN (green).....\$79.00/ea.
 PT68GKGS690GN (saddle).....\$79.00/ea.
 PT68GKGS697GN (sandalwood).....\$79.00/ea.

(With Cuts)

PT68GKGS100G (black).....\$119.00/ea.
 PT68GKGS468G (green).....\$119.00/ea.
 PT68GKGS690G (saddle).....\$119.00/ea.
 PT68GKGS697G (sandalwood).....\$119.00/ea.
 PT68GKGSJ (jute insulation).....\$25.00/ea.

1972 Gran Sport (Sport Coupe) 

(Without Cuts)

PT68GKGS100GN (black).....\$79.00/ea.
 PT68GKGS465GN (green).....\$79.00/ea.
 PT68GKGS690GN (saddle).....\$79.00/ea.

(With Cuts)

PT68GKGS100G (black).....\$119.00/ea.
 PT68GKGS465G (green).....\$119.00/ea.
 PT68GKGS690G (saddle).....\$119.00/ea.
 PT68GKGSJ (jute insulation).....\$25.00/ea.

TRUNK DIVIDERS & JUTE INSULATION

Die-cut reproductions of the black fiberboard panel that separates the trunk compartment from the passenger area. Trunk divider jute padding is recommended to provide insulation from moisture and reduces the amount of heat and noise from the trunk compartment.



1964-67 Skylark & Gran Sport 

TD64GK (Coupe models).....\$35.00/ea.
 TD64GKJ (jute insulation).....\$26.00/ea.

1968-72 Skylark & Gran Sport 

TD68GK (Coupe models).....\$35.00/ea.
 TD68GKJ (jute insulation).....\$26.00/ea.



TRUNK MATS

Original style rubber trunk mats die-cut to factory specifications to assure a correct fit. Please specify material pattern at time of order.

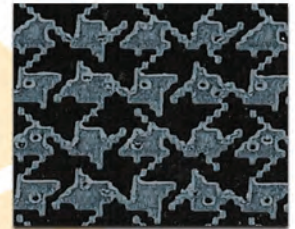

Houndstooth

TRUNK MATS

Original style rubber trunk mats feature correct backings and are die-cut from factory specifications to assure a correct fit. Available in original patterns and colors.

1964-65 Skylark & Gran Sport

TM64GK-GHT (Gray Houndstooth).....\$89.00/ea.
TM64GK-AHT (Aqua Houndstooth).....\$89.00/ea.

1966-67 Skylark & Gran Sport

TM66GK-GHT (Gray Houndstooth).....\$89.00/ea.
TM66GK-AHT (Aqua Houndstooth).....\$89.00/ea.

1968-72 Skylark & Gran Sport

TM68GK-GHT (Gray Houndstooth).....\$89.00/ea.
TM68GK-AHT (Aqua Houndstooth).....\$89.00/ea.

SPARE TIRE COVER

Add the finishing touch to your trunk with a spare tire cover to match your trunk mat. Made from the same trunk mat material, these covers will fit any vehicle with a floor mounted spare tire. Please specify material pattern at time of order.

1964-72 Skylark & Gran Sport

ST64GK-14GHT (14" Gray Houndstooth) ...\$59.00/ea.
ST64GK-15GHT (15" Gray Houndstooth) ...\$59.00/ea.
ST64GK-14AHT (14" Aqua Houndstooth) ...\$59.00/ea.
ST64GK-15AHT (15" Aqua Houndstooth) ...\$59.00/ea.

SPARE TIRE BOARD

Die-cut reproduction lid for your spare tire. These lids are made with the same patterns as the trunk mats and were used when the spare tire cover was not ordered.

1964-72 Skylark & Gran Sport

ST64GK-BLK (Black).....\$29.00/ea.
ST64GK-AHT (Aqua Houndstooth).....\$39.00/ea.

1968-72 Skylark & Gran Sport

ST68GK-SP (Speckled).....\$49.00/ea.

TRUNK MAT MATERIAL

Legendary Auto Interiors offers an uncut roll of trunk mat material in Houndstooth, Green/Gray or Herringbone for models not offered. You cut to size this 52" x 80" roll.



TMROLLHT (Gray Houndstooth)\$59.00/ea.
TMROLLAHT (Aqua Houndstooth).....\$89.00/ea.

1964-72 TRUNK AREA SPEAKER COVER

Die-cut using laminated fiberboard just like the originals, these speaker covers are lined with jute insulator for an exact reproduction.



1964-65 Skylark & Gran Sport

SC64GA (Coupe models).....\$29.00/ea.

1966-72 Skylark & Gran Sport

SC66GA (Coupe models).....\$19.00/ea.



VINYL TOPS CONVERTIBLE TOPS AND ACCESORIES

 facebook.com/legendaryautointeriors

 twitter.com/legendaryautoin

 www.legendaryautointeriors.com

 instagram.com/legendaryautointeriorsltd

 youtube.com/user/legendaryauto



VINYL TOPS

Legendary Auto Interiors, Ltd. "fitted" vinyl tops are manufactured to original specifications with the correct 100% cotton drill backing that gives trouble free installation and long term durability. All seams are double stitched and die-electrically heat-sealed insuring accurate deck width and seam durability. Each top is individually cut and fit for each specific year, make and model to give that perfect Legendary fit. Every Legendary vinyl top carries a (5) year factory warranty, the best in the industry!!

VINYL TOPS

1964-65 Skylark & Gran Sport

VTL28GA01S (satin black)..... \$379.00/ea.

VTL28GA02S (satin white)..... \$379.00/ea.

1966-67 Skylark & Gran Sport

VTL29GA01S (satin black)..... \$379.00/ea.

VTL29GA02S (satin white)..... \$379.00/ea.

1968-69 Skylark & Gran Sport

VTL30GHK01S (satin black)..... \$379.00/ea.

VTL30GHK02S (satin white)..... \$379.00/ea.

1970-71 Skylark & Gran Sport

VTL31GHK01S (satin black)..... \$379.00/ea.

VTL31GHK02S (satin white)..... \$379.00/ea.

1972 Skylark & Gran Sport

VTL31GHK01G (gloss black)..... \$379.00/ea.

VTL31GHK02G (gloss white)..... \$379.00/ea.

1972 Skylark Custom

VTL32GK01G (gloss black) \$379.00/ea.

VTL32GK02G (gloss white) \$379.00/ea.

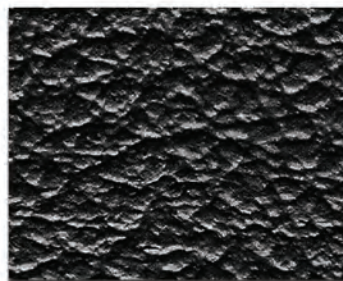

Levant Grain
(Black)

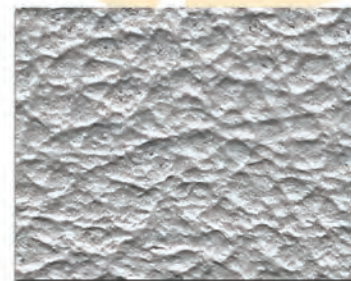

Levant Grain
(White)

NOS VINYL TOPS

Oldsmobile offered a variety of vinyl top colors other than black and white for F-85, Cutlass & 442 models. Colors such as blue, teal, green, gold and buckskin have not yet been reproduced. In our efforts to better serve you in your restoration needs, Legendary is continuously searching for NOS (New Old Stock) vinyl top material. Please call for more information.

VTNOS\$1129.00/ea.

Please specify year/make/model and color at time of order.

Convertible Top Color Samples

K.V. "Pinpoint Grain"

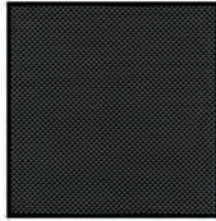

01 Black

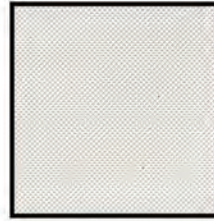

02 White

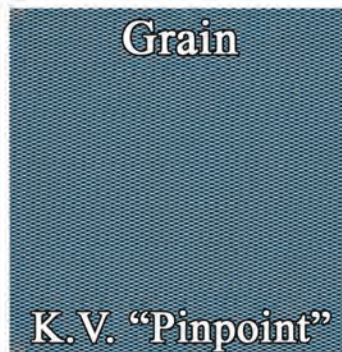

CONVERTIBLE TOPS



1971 Buick Skylark Custom

1964-65 Skylark & Gran Sport

CT64GA(C)T (Black and White only) \$399.00/ea.
CT64GA-P (Plastic curtain only) \$229.00/ea.

1968-72 Skylark & Gran Sport

CT68GAC)T (Black and White only) \$399.00/ea.
CG68GA(C) (Glass curtain only) \$244.00/ea.

1966-67 Skylark & Gran Sport

CT66GA(C)T (Black and White only) \$399.00/ea.
CT66GA-P (Plastic curtain only) \$229.00/ea.

CONVERTIBLE TOPS AND ACCESSORIES



Legendary Auto Interiors, Ltd. convertible tops are reproduced to factory original specifications using correct heavyweight 36oz. material. Convertible tops are available in the original KV "Pinpoint" grain on all 1964-72 Skylark & GS models. Rear window curtains are available in glass or plastic depending on year and model. We also have convertible tops available for many other models. For colors other than black and white and models not listed, please call for assistance. As with all Legendary Auto Interiors, Ltd. products, these reproduction convertible tops are the finest available and come with a (2) year manufacturer's warranty (glass curtains come with a (1) year warranty) against defects in materials and workmanship.

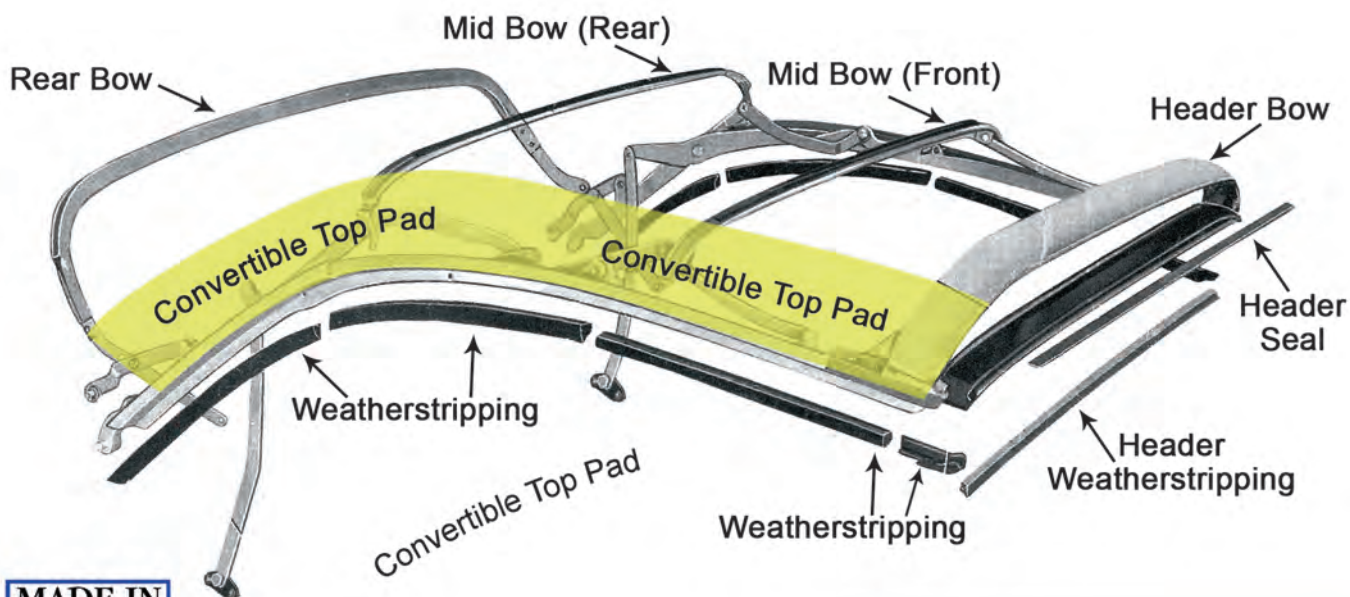

**1964-65 & 1968-72
CONVERTIBLE TOP GUIDE PIN**

These chrome plated pins screw into the top frame and slide into the header panel aligning the convertible top with the front windshield.



1964-65 Skylark & Gran Sport
1968-72 Skylark & Gran Sport
CT64GA-GUIDE..... \$10.00/ea.

**1964-72 CONVERTIBLE TOP
LATCH HOOK KNUCKLES**

Case-hardened steel reproductions are identical to the originals. These latch knuckles pivot at the front end of the latch assembly where the latch hooks (CT64GA-HOOK) thread into place. Complete with rolled press-on attaching pin.



1964-72 Skylark & Gran Sport
CT64GA-KNUCKLE..... \$49.00/pr.

**Skylark/Gran Sport
CONVERTIBLE TOP
TENSION CABLES**

These tension cables install into the cable sleeves that are sewn into the convertible top keeping it secure to the top frame.



1964-65 Skylark & Gran Sport
CT64GA-CABLE..... \$69.00/pr.

1966-67 Skylark & Gran Sport
CT66GA-CABLE..... \$69.00/pr.

1968-72 Skylark & Gran Sport
CT68GA-CABLE..... \$49.00/pr.

**1966-67 CONVERTIBLE TOP
PLASTIC GUIDE PINS**

These reproduction plastic guide pins, also known as anti-rattle plates, help align the convertible top when latched into place with the windshield header panel.



1966-67 Skylark & Gran Sport
CT66GA-GUIDE..... \$39.00/pr.

CONVERTIBLE TOP PADS

Universal convertible top pads fit between the top and metal frame rails, protecting the top from wear and damage. Highly recommended with installation of new convertible tops.



CTPAD74STD (1964-67)..... \$79.00/pr.
CTPAD68GA (1968-72)..... \$52.00/pr.

**1968-72 CONVERTIBLE
HEADER PANEL VINYL**

Pre-cut Madrid grain header vinyl wraps over the header bow that attaches to the front of the convertible top frame. Please specify year and color at time of order.

1968-72 Skylark & Gran Sport
VV68GAHEADER(C)..... \$29.00/ea.

**1964-72 CONVERTIBLE TOP
LATCH HOOKS**

Case-hardened steel reproduction hooks secure the top to the upper windshield framing. Chrome plated with pin-holed rubber punch mounting insert included.



1964-72 Skylark & Gran Sport
CT64GA-HOOK..... \$10.00/ea.

**1964-67 CONVERTIBLE TOP
MOTOR COVER**

Die-cut black laminated fiber board motor cover has been shape-formed to fit exactly like the original.



1964-67 Skylark & Gran Sport
TP64GA..... \$10.00/ea.

CONVERTIBLE BOOTS

Legendary Auto Interior's convertible boots feature protective foam pockets and are sewn to original factory specifications. We are the only manufacturer making "as original" convertible boots using authentic grain vinyls and correct metal snaps or clips by year and model. 1964 models use Seville grain vinyl and 1965-72 models use Madrid grain vinyl. Every Legendary convertible boot carries a (5) year factory warranty, the best in the industry!

1964 Skylark

CB64GA00017(C) (shown)
100G, 220G, 310G, 508G, 656G.....\$358.00/ea.
405G.....\$704.00/ea. (L1)

☞ 405G Metallic Green uses special run material.

CB64GAP0017(C) *(Plastic Clips)
100G, 220G, 310G, 508G, 656G.....\$358.00/ea.
405G.....\$704.00/ea. (L1)

☞ Plastic Clips are custom and therefore non-returnable, non-refundable

1964 (C) COLOR CODES

(100G) Black	(405G) Metallic Green
(220G) Frost White	
(325G) Light Metallic Blue	(508G) Red
	(656G) Brown

1965 Skylark & Gran Sport

CB65GA00017(C)
100G, 220G, 325G, 520G\$358.00/ea.
679G.....\$704.00/ea. (L1)

CB65GAP0017(C) *(Plastic Clips)

100G, 220G, 325G, 520G\$358.00/ea.
679G.....\$704.00/ea. (L1)

☞ Plastic Clips are custom and therefore non-returnable, non-refundable

1965 (C) COLOR CODES

(100G) Black	(520G) Metallic Red
(220G) Frost White	(679G) Saddle
(325G) Light Metallic Blue	

1966 Skylark & Gran Sport

CB66GA00017(C)
(All Colors).....\$344.00/ea.

1966 (C) COLOR CODES

(100G) Black	(325G) Light Metallic Blue
(240G) Metallic Parchment	(520G) Metallic Red

1967 Skylark & Gran Sport

CB66GA00017(C)
100G, 240G, 343G, 501G, 640G.....\$344.00/ea.
680G.....\$681.00/ea. (L2)

☞ 240G Metallic Parchment requires sample approval.

☞ 680G Saddle uses New Old Stock (NOS) material.

1967 (C) COLOR CODES

(100G) Black	(501G) Red
(240G) Metallic Parchment	(640G) Pearl Yellow
(343G) Dark Metallic Blue	(680G) NOS Saddle

1968 Skylark & Gran Sport

CB68GA00017(C)
100G, 220G, 333G, 502G, 709G.....\$287.00/ea.
135G.....\$646.00/ea.

CB68GAE0017(C) (early 68 w/ clips)

100G, 220G, 333G, 502G, 709G.....\$287.00/ea.
135G.....\$646.00/ea.

☞ 135G NOS Platinum requires sample approval.

1968 (C) COLOR CODES

(100G) Black	(333G) Teal Blue
(135G) NOS Platinum	(502G) Red
(220G) Frost White	(709G) Buckskin

1969 Skylark & Gran Sport

CB68GA00017(C)
(All Colors).....\$287.00/ea.

1969 (C) COLOR CODES

(100G) Black	(325G) Metallic Blue
(235G) Parchment	(503G) Red
(239G) Metallic Parchment	(710G) Buckskin

1970 Skylark & Gran Sport

CB68GA00017(C)
(All Colors).....\$287.00/ea.

1970 (C) COLOR CODES

(100G) Black	(658G) Burnished Saddle
(202G) Pearl White	(694G) Sandalwood

1971 Skylark & Gran Sport

CB68GA00017(C)
(All Colors).....\$287.00/ea.

1971 (C) COLOR CODES

(100G) Black	(690G) Saddle
(202G) Frost White	(697G) Sandalwood
(468G) Green	

1972 Skylark & Gran Sport

CB68GA00017(C)
100G, 465G, 690G\$287.00/ea.

1972 (C) COLOR CODES

(100G) Black	(465G) Green
(230G) White	(690G) Saddle



1969 Buick Skylark Custom

CONVERTIBLE WELL LINERS

These liners install behind the rear seat protecting your convertible top from wear and damage when placed in the down position. Legendary is the only manufacturer making factory exact well liners available today, backed by a (5) year factory warranty.

1964-65 Skylark & GS

WL64GA00016100G (black).....\$159.00/ea.
☞ No plastic strips or snaps. Staples to trim strip before convertible top is installed.

1966-67 Skylark & GS

WL66GA00016100G (black).....\$159.00/ea.
☞ Features a plastic attachment strip.

1968-72 Skylark & GS

WL68GA00016100G (black).....\$244.00/ea.
☞ Features a Rip-Stop plastic pocketed outer lining containing a thick layer of high loft felt.
☞ A LEGENDARY AUTO INTERIORS, LTD. EXCLUSIVE

CONVERTIBLE BODY SCREW STUDS



5/8" Phillips head stainless steel body screw studs for snap down boot and well liner applications.

CBBOOTBEZSCRW (Pkg/35) \$16.00/pk.

CONVERTIBLE BOOT DUST COVER

Protect your convertible boot with this convertible boot dust cover made in Levant grain with a satin finish. Comes in Black only







CB67MCBAG01..... \$72.00/ea.





WEATHERSTRIPING AND ACCESORIES

 facebook.com/legendaryautointeriors
 twitter.com/legendaryautoin

 www.legendaryautointeriors.com
 instagram.com/legendaryautointeriorsltd
 youtube.com/user/legendaryauto

DOOR WEATHERSTRIPPING

Thick molded rubber weatherstrip includes the necessary clips and correct molded endpads for an excellent fit. These pieces wrap around the bottom and sides of each door.

1964-65 Skylark & Gran Sport
WS64GA-DOOR (Sport Cpe. & Conv.)...\$99.00/pr.
WS64GA-DOORS (Coupe).....\$99.00/pr.

1966-67 Skylark & Gran Sport
WS66GA-DOOR (Sport Cpe. & Conv.)...\$99.00/pr.
WS66GA-DOORS (Coupe).....\$99.00/pr.

1968 Skylark & Gran Sport
WS68GA-DOOR (Sport Cpe. & Conv.)...\$99.00/pr.

1968-72 Skylark & Gran Sport
WS68GA-DOORS (Coupe).....\$99.00/pr.

1969-72 Skylark & Gran Sport
WS69GA-DOOR (Sport Cpe. & Conv.)...\$99.00/pr.

DOOR LOCK SEALS



These molded rubber "U" shaped seals screw onto the door jamb pillar to seal the front edge of the rear-down windows.

1964-65 Skylark & Gran Sport
 (Sport Coupe & Convertible)
WS64GA-DOORLK.....\$39.00/pr.

1966-67 Skylark & Gran Sport
 (Sport Coupe & Convertible)
WS66GA-DOORLK (shown).....\$49.00/pr.

1968-72 Skylark & Gran Sport
 (Sport Coupe & Convertible)
WS68GA-DOORLK.....\$49.00/pr.

ROOF RAIL WEATHERSTRIPPING

Thick molded rubber with correct molded endpads. These start at the base of the windshield pillar post and follow along the outer edge of the roofline to the rear of the quarter window.



1964-65 Skylark & Gran Sport
WS64GA-ROOF (Sport Coupe)\$99.00/pr.

1966-67 Skylark & Gran Sport
WS66GA-ROOF (Sport Coupe)\$99.00/pr.

1968 Skylark & Gran Sport
WS68GA-ROOF (Sport Coupe)\$89.00/pr.

1969-72 Skylark & Gran Sport (shown)
WS69GA-ROOF (Sport Coupe)\$99.00/pr.

HOOD-TO-COWL SEALS

This rubber piece seals the underside of the hood to the cowl. Installs on the front edge of the cowl area where the back edge of the hood meets.

1964-67 Skylark & Gran Sport
WS64GA-HOOD\$29.00/ea.

1968-72 Skylark & Gran Sport
WS68GA-HOOD\$29.00/ea.

REAR QUARTER WINDOW SEALS

These seals have a steel core molded inside the rubber and install into the chrome track located on the front edge of the rear roll-up quarter window.



1964-65 Skylark & Gran Sport
WS64GA-QTRH (Sport Coupe)\$39.00/pr.

1964-65 Skylark & Gran Sport
WS64GA-QTRC (Convertible)\$29.00/pr.

1966-67 Skylark & Gran Sport
WS66GA-QTR (Sport Cpe. & Conv.).....\$39.00/pr.

1968-72 Skylark & Gran Sport (shown)
WS68GA-QTR (Sport Cpe. & Conv.).....\$39.00/pr.

TRUNK SEALS

Trunk seal kits feature correct original profile extruded foam for hardtop, sports coupe and convertible models. These seal the trunk lid preventing water leaks. 16" in length.



1964-72 Skylark & Gran Sport
TS64GA.....\$29.00/ea.

COUPE / SPORT COUPE WEATHERSTRIPPING

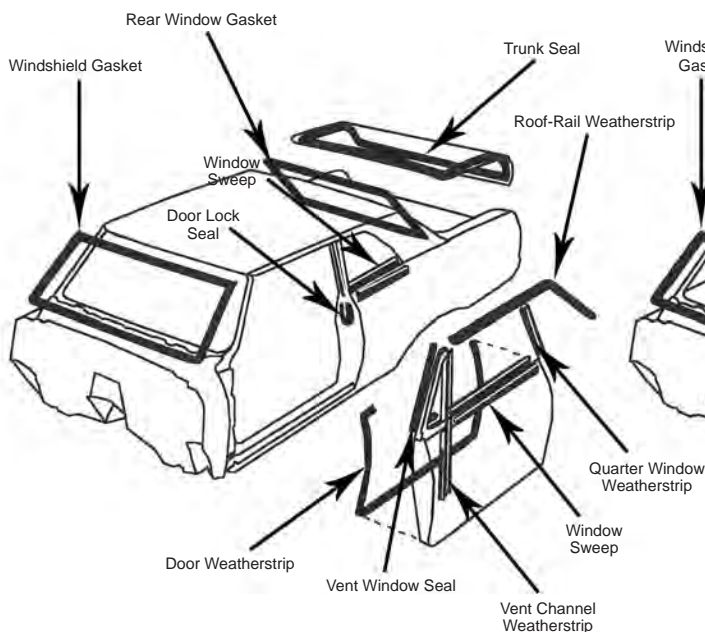

CONVERTIBLE WEATHERSTRIPPING

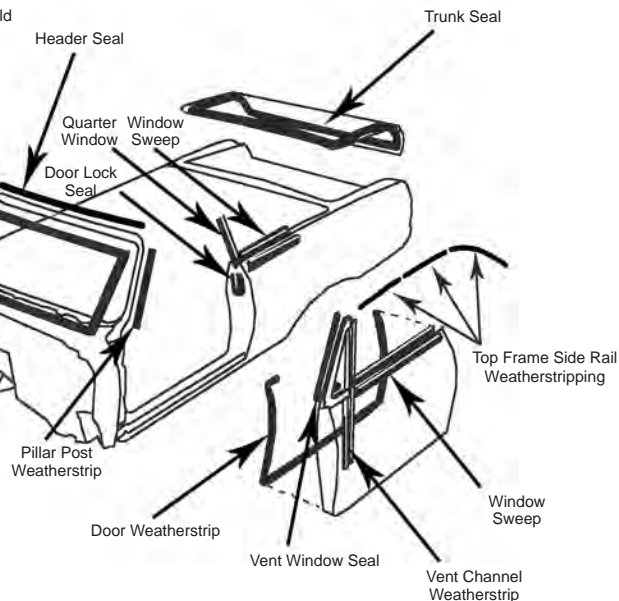

ORIGINAL-STYLE WINDOW SWEEP KITS

Original-style window felts are reproduced with a factory look half-rounded metal bead on the inner and outer channels. Available as complete sets of (8) weather-strips for inner and outer door glass and quarter glass on 2-door models.

1964 Skylark

WS64GKOWINDOWH (Sport Coupe) ... \$149.00/kit
WS64GKOWINDOWC (Convertible) ... \$149.00/kit
WS64GKOWINDOWS (Coupe) ... \$149.00/kit

1965 Skylark & Gran Sport

WS65GKOWINDOWH (Sport Coupe) ... \$149.00/kit
WS65GKOWINDOWS (Coupe) ... \$149.00/kit
WS65GKOWINDOWC (Convertible) ... \$149.00/kit

1966-67 Skylark & Gran Sport

WS66GKOWINDOWH (Sport Coupe) ... \$179.00/kit
WS66GKOWINDOWS (Coupe) ... \$179.00/kit
WS66GKOWINDOWC (Convertible) ... \$179.00/kit

1966-67 Special

WS66GKOWINDOWSS (Coupe) ... \$131.00/kit

1968 Skylark & Gran Sport

WS68GKOWINDOWH (Sport Coupe) ... \$179.00/kit
WS68GKOWINDOWC (Convertible) ... \$179.00/kit

1969 Skylark & Gran Sport

WS69GKOWINDOWH (Sport Coupe) ... \$179.00/kit
WS69GKOWINDOWC (Convertible) ... \$179.00/kit

1970-72 Skylark & Gran Sport

WS70GKOWINDOWH (Sport Coupe) .. \$179.00/kit
WS70GKOWINDOWS (Coupe) ... \$179.00/kit
WS70GKOWINDOWC (Convertible) ... \$179.00/kit

CONVERTIBLE TOP FRAME WEATHERSTRIPPING KITS

Complete convertible top frame kits consist of (1) rubber header seal and (6) molded rubber side rail pieces. (Header seal not shown)



1964-65 Skylark & Gran Sport

WS64GA-ROOFC (Convertible) ... \$289.00/kit

1966-67 Skylark & Gran Sport

WS66GA-ROOFC (Convertible) ... \$299.00/kit

1968-72 Skylark & Gran Sport

WS68GA-ROOFC (Convertible) ... \$349.00/kit

HEADER SEALS

Rubber header seal runs along the front of the top and seals against the top of the windshield.

1964-65 Skylark & Gran Sport

WS64GA-HS (Convertible) ... \$29.00/ea.

1966-67 Skylark & Gran Sport

WS66GA-HS (Convertible) ... \$49.00/ea.

1968-72 Skylark & Gran Sport

WS68GA-HS (Convertible) ... \$69.00/ea.

PILLAR POST WEATHERSTRIPPING

These weatherstrip pieces run along the side of the windshield frame A-pillar.

1964-65 Skylark & Gran Sport

WS64GA-WSP (Convertible) ... \$69.00/pr.

1966-67 Skylark & Gran Sport

WS66GA-WSP (Convertible) ... \$69.00/pr.

1968 Skylark & Gran Sport

WS68GA-WSP (Convertible) ... \$69.00/pr.

1969-72 Skylark & Gran Sport

WS69GA-WSP (Convertible) ... \$89.00/pr.

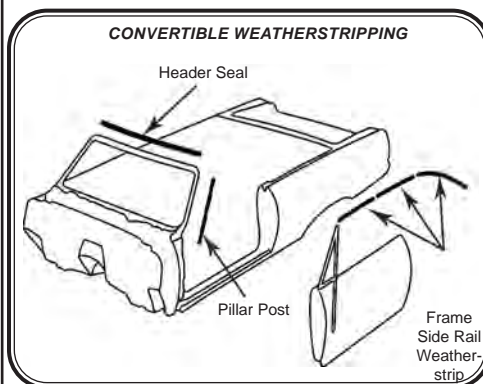

PLASTIC HOOD PAD CLIPS



Reproduction plastic hood pad clips for all 1968-72 Skylark & Gran Sport models.

HPGACLIP-P ... \$1.00/ea.

METAL HOOD PAD CLIPS



Reproduction of the original stamped metal hood pad clip for 1964-67 Skylark & Gran Sport models.

HPGACLIP-M ... \$3.00/ea.

HOOD PAD INSULATION

Die-cut reproductions of the original hood pads come ready to install. These insulating pads help quiet engine noise and absorb heat.



1964-67 Skylark & Gran Sport

HP64GK ... \$49.00/ea.
 ☞ Yellow insulation.

1968-72 Skylark & Gran Sport

HP68GK ... \$49.00/ea.
 ☞ Yellow insulation.

1968-72 Skylark & Gran Sport

HP68GK1 (shown) ... \$49.00/ea.
 ☞ Standard gray felt insulation.



Providing the automotive industry
with the world's highest quality
soft trim products and services
RIGHT HERE AT HOME

**STILL ASSEMBLED AND
MADE IN THE** ★★★★★
USA 

THERE REALLY IS A DIFFERENCE!!

Legendary
AUTO INTERIORS LTD.

www.legendaryautointeriors.com



ORDERING INFORMATION

HOW TO ORDER

MAIL, PHONE OR FAXES – When ordering by mail, please fill in all information on the order form that pertains to your vehicle. Print all information and include a telephone number where you can be reached during the day and evening. When ordering for more than one vehicle, please use separate order forms for each vehicle (see order forms in your Legendary Auto Interiors catalog). When ordering by phone, please have your customer number and a list of items ready. You may order conveniently by phone 8:00AM to 6:00PM EST Monday-Friday. Orders may also be sent in by fax 24 hours a day, 7 days a week. Please note that orders faxed in on Saturday or Sunday will not be received and processed until Monday. FAX: 1-800-732-8874

ON-LINE ORDERING – Legendary Auto Interiors, Ltd also offers convenient and easy on-line ordering 24 hours a day, 7 days a week at www.legendaryautointeriors.com. Click on the “Shop Online” tab in the options menu and follow the ordering procedures. Upon completion, Legendary Auto Interiors, Ltd will follow up with an email confirmation so you can verify that your order has been received correctly and is being processed. You may also choose to email your orders by contacting our sales department at sales@legendaryautointeriors.com.

METHODS OF PAYMENT

CREDIT CARDS – Legendary Auto Interiors, Ltd accepts Visa, MasterCard, American Express and Discover for your convenience. Please include the cardholder’s name, billing address, home and business phone, credit card number, expiration date and the 3 or 4 digit security code when placing your orders. Without this information it may slow the processing of your order.

CHECKS AND MONEY ORDERS – Personal Checks will be held 5 business days. To expedite your orders, we suggest paying by Certified Bank Check or Money Order. COD orders are no longer accepted. All payments MUST be in U.S. funds.

SHIPPING SERVICES

DOMESTIC SHIPPING - Legendary Auto Interiors Ltd utilizes both UPS and FedEx Ground for most U.S. parcel shipments which provides our customers the most efficient and cost effective shipping services available. We will ship by the best method for your geographic area unless otherwise specified. We also offer specialized shipping services such as 3 day Select, 2nd day air and Next Day Air for your convenience.

INTERNATIONAL SERVICES – We use the most current and most cost effective international parcel shipping companies available to provide both “Door to Airport” and “Door to Door” services to our overseas customers. We utilize UPS Canadian and FedEx International for Canadian shipments. This provides us with the best possible shipping and brokerage fees for our international customers.

DAMAGES AND SHORTAGES

The carrier is responsible for any merchandise lost or damaged in transit. **Should a package appear to be damaged, OPEN the package while the carrier’s driver is present and note all damages and/or shortages.** If this is not possible and you discover damaged goods or shortages, contact our Customer Service Department immediately! Damages and/or shortage claims must be made within 5 days of receipt of merchandise to ensure our ability to file a claim with the carrier. Please be sure to check all merchandise when you receive it and again before attempting installation.

Legendary Auto Interiors, Ltd. is committed to providing the highest possible level of customer service, however on rare occasions circumstances beyond our control can result in lost or damaged packages. To protect our customers against delays and having to make time consuming phone calls to the carrier, orders will incur a modest \$2.50 insurance fee on each shipment. In the event any products become lost or damaged we will then send replacement parts as quickly as possible, subject to material availability. We will also file the claims and deal with the carrier.

Carriers allow a short period of time to file claims. To take advantage of this service you must notify Legendary Auto Interiors, Ltd. of any damages within 5 days of receiving your delivery. Failure to contact us within this 5 day window will negate Legendary Auto Interiors further involvement.

RETURN POLICY

Legendary Auto Interiors Ltd. will accept the return of products for a full refund or exchange up to 30 days from the original invoice date with no re-stocking fee. Returns after a 30 day period, but before 60 days will be subject to a 25% restocking fee. No returns will be accepted after 60 days. Custom, Special Orders, Specialty Run Materials, Leather and NOS are not eligible for return under any circumstances other than a manufacturing defect. If any product is modified, altered, painted, installed or disassembled in any way without Legendary’s expressed written permission, the item is non-returnable. Legendary always recommends professional installation on all products. Any item which has been altered, painted, installed or deemed non-resalable by Legendary will be returned to the customer at the customer’s expense. Legendary is not responsible or liable for labor fees associated with the installation, modification or repair of any product purchased regardless of the circumstances.

RETURN GOOD INFORMATION

All returns must receive prior approval and an RMA (Return Merchandise Authorization) number prior to return shipping. Packages received by Legendary Auto Interiors Ltd. without prior approval and RMA number will be refused. Return shipping and insurance are the customers responsibility. All returned items must be received in as new condition. Examples that render a product non-returnable include, but are not limited to: evidence of attempted installation, parts that have been bent, broken, creased, scratched, soiled, melted or discolored. Also, we will not accept returns for any items that have been altered, painted, repaired or for any reason that has rendered the product non-returnable. Warning: Legendary is not responsible for damaged or lost packages returned by the customer.

CANADIAN CUSTOMER RETURNS

Warranty returns must be clearly marked as follows: **“U.S. GOODS BEING RETURNED FOR REPAIR OR REPLACEMENT UNDER WARRANTY COMMODITY CODE 9801:00V0”**.

PRICES

All prices effective December 31st, 2021 and are subject to change without notice.

HOURS

Monday – Friday 8:00AM to 6:00PM (Eastern Standard Time)

Saturday - By appointment only please

IMPORTANT ADDITIONAL INFORMATION

WARRANTY INFORMATION

Legendary Auto Interiors, Ltd proudly stands behind all of the products and services we offer. All Legendary manufactured interior soft trim products are backed by an exclusive **Limited Lifetime Warranty** for as long as you own your car. In addition, we offer a 5-year warranty on all of our molded and exterior soft trim products. Legendary Auto Interiors, Ltd also offers a huge selection of interior components, which we warranty for a minimum of 1 year in accordance with the original manufacturers product warranty. **Product Disclaimer: Normal wear from use or problems due to improper installation are excluded from any warranty.**

LEGENDARY GUARANTEE

All Legendary Auto Interiors, Ltd manufactured products are made to original specifications and are guaranteed to fit. In the event that you experience a problem with any of our products or are dissatisfied with our service, we will make every effort to resolve and correct your issue promptly and do our best to make sure that you are completely satisfied.

INTERIOR COLORS/GRAINS

Legendary Auto Interiors, Ltd offers one of the most diverse product lines available in the marketplace. We feature the correct "color matched" and "grain matching" materials for nearly all models and styles. Due to the extensive number of colors produced by Chrysler, AMC and General Motors, there are some colors, which are simply not available in reproduction form. As the demand for colors increases, we are constantly having previously unavailable colors reproduced. In the event that a vinyl or cloth is not available in reproduction form, the use of NOS material may be required. Please inquire for a current quote, as the price and availability of these NOS materials will vary. To ensure a correct color and grain match, your interior trim code may be required for verification. As color dye lots will vary, we recommend purchasing all your soft trim components at the same time to ensure an exact color match of all components throughout your interior. **Color and grain samples are available upon request at no charge.**

LEATHER INTERIORS

Legendary Auto Interiors, Ltd produces a large number of "as original" leather interiors that are color matched to the original. Special order custom leather interiors are also available upon request. Some applications may require a clean, non-faded sample to ensure the closest possible color match. Leather interior orders may require additional lead-time as well as additional costs, which will be quoted at time of your order. **Note: Due to the variable nature of real leather, minor marks and features are normal and add to the character & individuality of leather products.**

CUSTOM ORDERS

In addition to "As Original" reproduction interiors, Legendary Auto Interiors, Ltd specializes in and is proud to feature "CUSTOM" interiors servicing the Resto-Mod enthusiast. With the introduction of our new & exclusive *Legendary* product, custom orders have taken on an entirely new look and have given enthusiasts almost limitless options to create a one of a kind interior. Special Order and Custom interiors require approval for all designated materials being used and a signature approval on a "Custom Order" form is also required. Once the Custom work has been approved these orders must be prepaid and are Non-Returnable, Non-Refundable and Non-Cancelable.

INSTALLATION NOTES

Since age deteriorates certain areas of seats due to wear patterns and foam breakdown, certain adjustments and foam repair may be required to complete a perfect fit installation. For this reason, we recommend having a professional automotive interior trim/upholstery shop install your new Legendary Auto Interiors, Ltd soft trim products. As the manufacturer, we know how to install our products better than anyone and we offer complete installation services for both seat upholstery and door panels. For further information, see the **INSTALLATION GUIDE** included with your seat upholstery and door panels or the installation page of this catalog.

PRODUCT DEVELOPMENT & PATTERNS NEEDED

In an effort to develop new upholstery kits, door panels and other soft trim products we work hand in hand with many of our customers who provide their original parts for product development. These items must be ORIGINAL, in fair to good condition and have not been previously repaired or replaced in any way. Our Sales Department must be contacted directly before sending your old upholstery or other soft trim products to us. Since we have no idea about the usability of your parts until we receive them in, you may initially be asked to send photos in an effort to identify the condition of your original parts. Please remember that even if you send in your parts for inspection, we may not be able to use them. **PLEASE NOTE THAT OLD UPHOLSTERY AND OTHER SOFT TRIM ITEMS CANNOT BE RETURNED TO YOU, AS THEY WILL BE DISMANTLED FOR DEVELOPMENT USE.**

MAINTENANCE

All Legendary Auto Interiors, Ltd products may be cleaned with a mild soap and warm water solution. Never scrub or use any kind of harsh pads, brushes or detergents. After cleaning with mild soap and water, lightly clean again with an industrial grade wax and grease remover. (Contact your local auto parts store) Allow surface to dry. LIGHTLY mist with the vinyl protectant of your choice. Install your new parts into your cruising machine. Sit back, enjoy the ride and drive safely!! Note: On leather upholstery applications we recommend using a high-quality mink oil, neatsfoot oil and/or wax. Hand apply, let stand 30-60 minutes and then wipe /buff clean. LIGHTLY rub your soft trim product with oil and wipe excess oil from the surface. **DO NOT USE SILICONE BASED PRODUCTS** as they will deteriorate the thread and dry out leather.

INSTALLATION SERVICES

GM, CHRYSLER & AMC SEAT UPHOLSTERY

(Includes tear down of original upholstery and installation of new upholstery)



Front Buckets Install - \$500.00/pr.
(No Headrest Covers)



Front Buckets w/ Headrest Covers Install - \$600.00/pr.



Front Split Bench Install - \$575.00/ea.



Front Split Bench w/ Headrest Covers Install - \$675.00/ea.



Rear Bench Seat Install - \$400.00/ea.



Headrest Covers Install - \$150.00/pr.

Center Armrest Install - \$150.00/ea.
(for models w/ buckets and no console)



SAVE ON COMPLETE FRONT & REAR INSTALLS!!

Front Buckets & Rear Bench Seat Install - \$750.00/set

Front Buckets w/ Headrest Covers & Rear Bench Seat Install - \$850.00/set

Front Split Bench & Rear Bench Seat Install - \$825.00/set

Front Split Bench w/ Headrest Covers & Rear Bench Seat Install - \$925.00/set

NOTE* Basic installations DO NOT include new foam and cotton replacement or reconstruction, media blasting, painting, welding, frame straightening, polishing or trim detailing. These services are additional and available at an hourly rate. Please call for more details. **1-800-363-8804*

INSTALLATION SERVICES

GM, CHRYSLER & AMC DOOR PANELS

Basic Door Panel Installation

(Includes installation of metal rails and window weatherstrip)

*Convertible rear panel installation DOES NOT include ashtray/well covers
*Ashtray/well covers for General Motors models are available. Call for details



Front Panels (Pair Only) - \$250.00/pr.



Hardtop/Convertible Rear Panels (Pair Only) - \$250.00/pr.

Complete Front & Rear Panels (Pairs Only) - \$500.00/pr.

Deluxe Door Panel Installation

(Includes installation of metal rails, window weatherstrip, metal trim and decorative emblems)

*Convertible rear panel installation DOES NOT include ashtray/well covers
*Ashtray/well covers for General Motors models are available. Call for details



Front Panels (Pair Only) - \$400.00/pr.



Hardtop/Convertible Rear Panels (Pair Only) - \$325.00/pr.

Complete Front & Rear Panels (Pairs Only) - \$725.00/pr.

DOOR PANEL REFURBISHMENT

If we do not list your particular year/make/model vehicle, Legendary Auto Interiors, Ltd. can refurbish your panels back to original for you. The following refurbishing rates include installation of new panels (on your original metal rails), inner window weatherstripping, metal trim and decorative emblems. Please call for instructions before shipping your door panels.

Front Panels (Pair Only) - \$750.00/pr.

Hardtop/Convertible Rear Panels (Pair Only) - \$500.00/pr.

Complete 2-Door Front & Rear Panels (Pairs Only) - \$1250.00/set

Complete 4-Door Front & Rear Panels (Pairs Only) - \$1250.00/set

NOTE Custom refurbishing does not include the refinishing of metal trim and decorative emblems. We highly recommend this work is done before sending the panels.



121 West Shore Boulevard, Newark, New York 14513
 Ph: 800-363-8804 • Fx: 800-732-8874 • www.legendaryautointeriors.com

Date:	Inv#:
Source:	Ord#:
Slsp:	Cust#:
Customer P/O#:	

Sold To:	Ship To:

Day Phone: () -	<input type="checkbox"/> Approved sample at show
Evening Phone: () -	<input type="checkbox"/> Customer Initials: _____
Fax: () -	<input type="checkbox"/> Custom Orders
Email Address:	are non-returnable/non-refundable/non-cancelable/prepaid

CC#: _____ x _____ x _____ exp: ____/____ CVC# _____

TERMS: CASH CHECK AMEX M/C
 VISA DISCOV MONEY ORDER

Year/Make/Model: _____ Int. Color: _____ Int. Code: _____

2DR 4DR HTP SDN CNV CPE FSTBK AUTO 4SP CLMN FLR CNSL
 BUCKET BENCH CAR FIXED/FOLD-DWN REAR AIR NO AIR PWR MAN # Bows in Headliner _____

Qty	Unit	Part #	Description	Unit \$	Shipping \$	Total \$

Shipping: <input type="checkbox"/> Complete <input type="checkbox"/> UPS <input type="checkbox"/> Fed Ex <input type="checkbox"/> BAX <input type="checkbox"/> Other: _____	Totals:
<input type="checkbox"/> Courtesy Call <input type="checkbox"/> Call Before Shipping	Sub Total
Amount charged at show \$ _____ Auth # _____ Forced _____	State Tax
	County _____
	Total
	Deposit
Signature: _____	Amount Due



121 West Shore Boulevard, Newark, New York 14513
 Ph: 800-363-8804 • Fx: 800-732-8874 • www.legendaryautointeriors.com

Date:	Inv#:
Source:	Ord#:
Slsp:	Cust#:
Customer P/O#:	

Sold To:

Ship To:

Day Phone: () -
 Evening Phone: () -
 Fax: () -
 Email Address:

Approved sample at show
 Customer Initials: _____
 Custom Orders
 are non-returnable/non-refundable/non-cancelable/prepaid

CC#: _____ x _____ x _____ exp: ____/____ CVC# _____

TERMS: CASH CHECK AMEX M/C
 VISA DISCOV MONEY ORDER

Year/Make/Model: _____ Int. Color: _____ Int. Code: _____

2DR 4DR HTP SDN CNV CPE FSTBK AUTO 4SP CLMN FLR CNSL
 BUCKET BENCH CAR FIXED/FOLD-DWN REAR AIR NO AIR PWR MAN # Bows in Headliner _____

Qty	Unit	Part #	Description	Unit \$	Shipping \$	Total \$

Shipping: <input type="checkbox"/> Complete <input type="checkbox"/> UPS <input type="checkbox"/> Fed Ex <input type="checkbox"/> BAX <input type="checkbox"/> Other: _____	Totals:
<input type="checkbox"/> Courtesy Call <input type="checkbox"/> Call Before Shipping	Sub Total
Amount charged at show \$ _____ Auth # _____ Forced _____	State Tax County _____
	Total
	Deposit
Signature: _____	Amount Due

SHIPPING/HANDLING RATE CHART

<u>Order Value \$</u>	<u>Flat Rate</u>	<u>Oversize Charges</u>	<u>Rate</u>
.01-40	\$8	OS1	\$21
41-100	\$18	OS2	\$41
101-200	*\$27	OS3	\$59
201-400	*\$34	Insurance	*\$3.50
401-600	*\$39		
601-800	*\$62		
801-1000	*\$90		
1001-1250	*\$109		
1251-1500	*\$137		
1501-1850	*\$172		
1851-2100	*\$206		
2101-2500	*\$235		
2501-2999	*\$265		
3000-up	*\$293		

*Includes \$3.50 for insurance

*On all orders over \$100

*NYS Customers - Sales tax will be added

*AK, HI, PR & International customers call for shipping

*Next Day, 2nd Day & 3 Day Select shipping, please call for rates

<u>Oversize Items</u>	<u>Classification</u>
Package Tray	OS1
Trunk Divider	OS1
Plastic Door Panels	OS1
Pre-Assembled Door Panels	OS1
2nd Gen F-Body Door Panels	OS1 
Consoles	OS1
Bucket Molded Foam	OS1
Install Kits 2-5, 12-15	OS1
Vinyl Yardage (1yd & up)	OS1

<u>Oversize Items</u>	<u>Classification</u>
Molded Headliners	OS3
Molded Hood Pads	OS3
Pick Up Seat Back Kits	OS3 
GM Bench Seat Foam	OS3
E-Body Dash Pads/Caps	OS3
Trunk Packages	OS3

<u>Oversize Items</u>	<u>Classification</u>
C-Body Carpet Kits	OS2
62-65 B Body Mopar Carpet Kits	OS2
Carpet Yardage	OS2 
Sound Dampeners	OS2
Firewall Insulation	OS2
Convertible Glass	OS2

2023 TENTATIVE SHOWS AND DATES

Spring Carlisle
Chryslers @ Carlisle
Fall Carlisle
SEMA

Carlisle, PA
Carlisle, PA
Carlisle, PA
Las Vegas, NV

April 19 - 23, 2023
July 14 - 16, 2023
Sept. 27 - Oct. 1, 2023
Oct. 31 - 3, 2023

Due to the ongoing COVID-19 pandemic the above dates are tentative and are subject to being changed or cancelled. For updates please check our website at www.legendaryautointeriors.com or call us at 1-800-363-8804.

Legendary Auto Interiors Ltd. welcomes the opportunity to support the smaller clubs' and organizations' car shows and swap meets. A variety of flyers, catalogs and gift certificates are available to clubs and organizations who sponsor shows nationwide. Please call or write for additional information. The list above is a tentative schedule subject to change without notice. Come visit us at many car shows/swap meets and see what makes a Legendary interior... truly Legendary.



Legendary
AUTO INTERIORS LTD.

Table of Contents - Skylark & Gran Sport

SEAT UPHOLSTERY & TRIM ACCESORIES 11-119

Bench Seatback Release Knob.....	116	Bucket Seat Spring Assembly	116
Bucket Seat Back Panels	118	Cotton Rolls	117
Bucket Seat Back Release Buttons.....	117	Headrest Covers.....	113-115
Bucket Seat Bases	118	High Density Foam	117
Bucket Seat Chrome Trim	118	Hog Ring Plier Kits	117
Bucket Seat Headrests.....	116	Muslin	117
Bucket Seat Headrest Lock Assembly.....	117	Seat Adjustment Knobs	116
Bucket Seat Headrest Mounting Kit.....	116	Seat Back Bumpers.....	116
Bucket Seat Hinge End Cap.....	117	Seat Bottom Stretch Panel Boards.....	117
Bucket Seat Mount Conversion Brackets.	116	Seat Upholstery	112-115

MOLDED FOAM & FOAM ACCESORIES 119-122

Installation Services.....	122
Molded Foam.....	120
Seat Upholstery Installation Kits.....	121

DOOR PANELS & TRIM ACCESORIES 123-134

Armrest Bases	130	Door Panel Trim Molding.....	132
Armrest Base Chrome Back Plate.....	130	Door Panel Watershields.....	134
Armrest Base Molding	131	Door Panel Windlace.....	132
Armrest Base Screw Set	131	Door Sill Plates	134
Armrest Pads.....	130	Door & Window Handle Plastic Washer	133
Ashtrays.....	131	Door & Window Handle Retaining Clip.....	133
Armrest/Ashwell Covers	124-130	Hinge to Door Bolts	131
Ashwell Installation Pad Kits.....	131	Jute Backing.....	134
Conv. Courtesy Light Lens & Bezels	131	Lower Door Hinge Pins.....	134
Door Handles	133	Lower Door Spring.....	134
Door Hinges.....	134	Seat Belt Bolts	134
Door Jamb Windlace	132	Upper Door Jamb End Caps	132
Door Lock Ferrules	132	Vent Window Cranks	133
Door Lock Knobs	132	Vent Window Handles	133
Door Lock Striker.....	134	Window Crank Handles	133
Door Panels.....	124-129	Window Handles Springs	133
Door Panel Clips & Retainers.....	132		
Door Panel Emblems.....	134		

CARPETS, FLOORMATS & ACCESORIES 135-145

Carpet.....	138	Floormat Color Selector.....	142
Carpet Color Selector	137	Kick Panels.....	138
Carpeted Floormats.....	145	Kick Panel Carpet.....	138
Carpet Yardage	138	Kick Panel Insulation	138
Floormats.....	143-144	Sound Deadener	138
		Sound Dampening.....	138

DASHES, CONSOLES, SHIFTERS & ACCESORIES 150-152

Console & Dash Inserts.....	151	Pedal Pads & Bezels	151
Dash Pad Emblems.....	152	Shifter Boots.....	152
Firewall Guard Fastener	152	Steering Column Covers	152
Firewall Insulation.....	152	Steering Column Seal.....	152
Gas Pedal Rod Pin.....	151	Underdash Insulation.....	152
Gas Pedal Spring	151		
Glovebox Liners.....	151		

Table of Contents - Skylark & Gran Sport

HEADLINERS & TRIM ACCESORIES 153-158

Dome Light Lens & Bezels	156	Pillar Post Moldings	156
Convertible Sunvisor Brackets	158	Rear Window Trim	155
Courtesy Light Lens & Bezels	156	Sail Panel Boards	156
Headliners	155	Sunvisors	158
Headliner Bow Retainer Clips	155	Sunvisor Supports	158
Headliner Color Selector	154	Sunvisor Tip & Bushing Kit	158
Headliner Insulation	155	Upper Windshield Trim	155

PACKAGE TRAY AND TRUNK ACCESORIES 159-162

Package Tray & Jute Insulation	160-161
Spare Tire Cover & Board	162
Trunk Area Speaker Cover	162
Trunk Divider & Jute Insulation	162
Trunk Mats	162
Trunk Mat Material	162

VINYL TOPS, CONVERTIBLE TOPS & ACCESORIES 163-168

Convertible Body Screw Studs	168
Convertible Boots	168
Convertible Header Panel Vinyl	167
Convertible Tops	165
Convertible Top Color Selector	165
Convertible Top Guide Pin	167
Convertible Top Latch Hooks	167
Convertible Top Latch Hook Knuckles	167
Convertible Top Motor Cover	167
Convertible Top Pads	167
Convertible Top Plastic Guide Pins	167
Convertible Top Tension Cables	167
Convertible Well Liners	168
Vinyl Tops	164

WEATHERSTRIPPING & ACCESORIES 169-171

Convertible Top Frame Weatherstrip Kit	171
Door Lock Seals	170
Door Weatherstripping	170
Header Seals	171
Hood Pad Clips	171
Hood Pad Insulation	171
Hood to Cowl Seals	170
Pillar Post Weatherstripping	171
Rear Quarter Window Seals	170
Roof Rail Weatherstripping	170
Trunk Seals	170
Window Sweep Kits	171



OVER 225 DIFFERENT INTERIOR STYLES OFFERED FOR CHRYSLER & AMC

1957-76 MOPAR A,B,C,E & F-BODY, 1963-68 DODGE A-100 VAN
1973-79 DODGE TRUCK & 1968-74 AMC JAVELIN/AMX

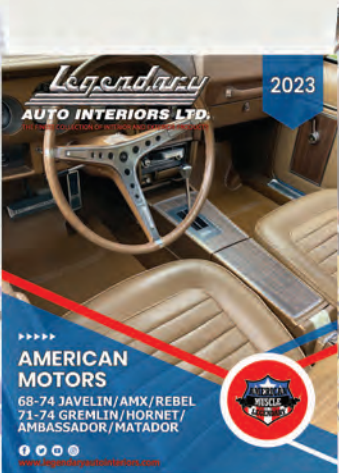
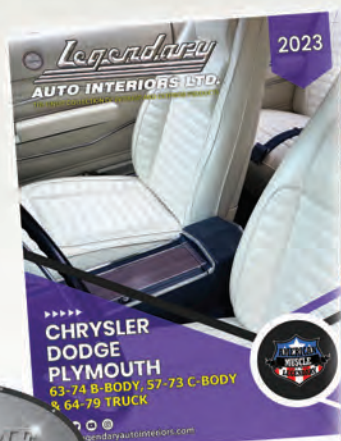

WWW.LEGENDARYAUTOINTERIORS.COM

Legendary Auto Interiors, Ltd.
121 West Shore Blvd
Newark, NY 14513



 twitter.com/legendaryautoin

 youtube.com/user/legendaryauto

 facebook.com/legendaryautointeriors

 instagram.com/legendaryautointeriorsltd

LEGENDARY AUTO INTERIORS

1-800-363-8804

WWW.LEGENDARYAUTOINTERIORS.COM